

Electronic Music Studios London Ltd (EMS), the Synthi 100 synthesizer and the construction of electronic music histories

Frances Morgan (205617)

This thesis represents partial submission for the degree of Doctor of Philosophy at
the Royal College of Art.

I confirm that the work presented here is my own. Where information has been derived from other sources, I confirm that this has been indicated in the thesis. During the period of registered study in which this thesis was prepared, the author has not been registered for any other academic award or qualification. The material included in this thesis has not been submitted wholly or in part for any academic award or qualification other than that for which it is now submitted.

Frances Morgan
07/01/2020

Abstract

The study of the institutional electronic music studio has become a popular way of framing historical narratives of postwar electronic music. Recent studies of sonic and musical devices from a material cultures perspective likewise construct histories of electronic music through its technologies.

My investigation into Electronic Music Studios (EMS), which was both a studio and an electronic instrument company, starts from a reading of this literature. It also combines archival research with readings from philosophy of technology and science and technology studies (STS) to critically explore the multiple temporalities, discontinuous narratives, and wider cultural significance of electronic music histories.

Founded in London in 1969 by Peter Zinovieff, EMS was set up during a period of exciting developments in music, art, design and technology in the UK. It was unique in being both a private studio which hosted prominent composers, and a manufacturer of commercial synthesisers under the name EMS London Ltd. The computer-controlled ‘hybrid’ studio system developed at EMS was among the most advanced of its kind, making EMS an important location in the international development of computer music in the 1970s. I examine the role of the computer in music and other art forms in the late 1960s and early 1970s, asking how wider cultural perceptions of new digital technology affected ideas about computing and creativity.

As an instrument manufacturer, EMS was, and is, best known for its VCS3, a small analogue synthesizer launched in 1969. In this study, I focus mainly on the Synthi 100, a large hybrid digital/analogue synthesizer developed in 1970–71. I chart the development of this instrument from its invention to its rehabilitation in the present day. Examining how the Synthi 100 was acquired and used at the BBC Radiophonic Workshop, London, and the Electronic Studio at Radio Belgrade, I consider the importance of EMS’s instruments and philosophies to different electronic music studio cultures in the 1970s. Through the lens of the ‘new organology’ of John Tresch and Emily Dolan as well as Susan Leigh Star’s notion of the ‘boundary object’, I develop a ‘map of mediation’ around the Synthi 100 and its users.

A number of projects to restore Synthi 100s have taken place in the last decade, both privately and with institutional support. Through a case study of a recent restoration project, I demonstrate that reconstruction and restoration processes help to illustrate the changing status of an historical electronic instrument, from investment

through obsolescence, to become a new compositional tool, and, finally, a valuable object through which the cultural heritage of an institution can be enhanced.

In conclusion, I propose that the complex entanglement of past and present in electronic music histories can be perceived through the reoperationalisation of historical music technologies.

Table of Contents

List of Illustrations.....	8
Chapter 1	10
Introduction: Electronic Music and Histories of the Studio.....	10
1.1. Introduction	10
1.2. A note on electronic music	12
1.3. A brief history of EMS	15
1.3.1 EMS: a London studio?.....	15
1.3.2 Cybernetics, computers and ‘inspirational’ compositions	20
1.3.3 A national studio and international studio cultures.....	23
1.3.4 Endings, new beginnings and alternative histories	26
1.4 Background to this study	29
1.5 Inside the electronic music studio: a survey of studio studies	30
1.5.1 Spaces of collaboration and conflict	37
1.5.2 Studio studies and musical works	40
1.6 Studios within studios: synthesizer historiography, organology and EMS 43	
1.7 Conclusion	45
Chapter 2	51
Electronic music in public: kinetic art, computer music, shared technologies and divergent aims.....	51
2.1 Introduction	51
2.2 Sound, light and sculpture: Unit Delta Plus at the Watermill Theatre 53	
2.2.1 <i>Random Together 1</i>	55
2.2.2 Unit Delta Plus and kinetic art	57
2.3 Alan Sutcliffe, ZASP and the Computer Arts Society	60
2.3.1 Machines Like Men: computing and composing in the 1960s	62
2.3.2 The Computer Arts Society, Cybernetic Serendipity and Event One. 65	
2.4 Electronic music and the new music establishment: Tristram Cary, the Redcliffe concerts and the Royal College of Music.....	69
2.4.1 EMS at the QEH	69
2.4.2 Tristram Cary and plans for a national studio.....	74
2.5 Conclusion	80
Chapter 3: Composing with computers, 1969–70	86
3.1 Introduction.....	86
3.2 The hybrid studio.....	87
3.3 A computer language for electronic music.....	92
3.4 Hybrid practices: collaborating with composers	95
3.4.1 <i>Chronometer</i> : questions of authorship	99
3.4.2 <i>Medusa</i> : questions of transformation	100
3.5 Developing a discourse of electronic music	103
3.5.1 EMS in the media.....	103
3.5.2 International perspectives on electronic music in society.....	107
3.6 Innovation and limitations	110
3.7 Conclusion	113
Chapter 4	118

EMS London Ltd and the early synthesizer industry	118
4.1 Introduction	118
4.2 Instrumentality, technology and electronic music.....	120
4.3 The VCS3.....	124
4.4 Saving time: voltage-control synthesis.....	132
4.5 Creating time: the Synthi 100.....	141
4.6 Conclusion	147
Chapter 5	154
‘A roomful of instruments’: the Synthi 100 at the BBC.....	154
5.1 Introduction	154
5.2 The Synthi 100 as a boundary object.....	156
5.3 Electronic music and audiovision.....	158
5.3.1 Modernising the Workshop.....	158
5.3.2 Between sound and music.....	160
5.3.3 Switching to synthesizers.....	165
5.4 A triumph of collaboration: the IEE concert.....	168
5.5 The rise and fall of the Delaware.....	169
5.6 Conclusion	175
Chapter 6	181
‘Openness to all phenomena’: The Radio Belgrade Electronic Studio.....	181
6.1 Introduction	181
6.2 Commissioning, installing and problem-solving: EMS and Radio Belgrade	186
6.3 The public presence of the Electronic Studio.....	193
6.4 ‘Indirectly forbidden’: electronic music in Yugoslavia.....	195
6.5 Thinking in the studio: theory and practice.....	199
6.6 Composing with the Synthi 100	205
6.6.1 Dialogues between sound worlds.....	206
6.6.2 Testing the hardware	208
6.6.3 Automated processes and organic machines.....	211
6.7 Conclusion	213
Chapter 7	221
From studio relic to performance instrument: new presentations of the EMS Synthi 100.....	221
7.1 Introduction	221
7.2 The demise and revival of the Radio Belgrade Electronic Studio.....	223
7.3 Networks of reoperationalisation	226
7.3.1 Restoring the Synthi 100 in Belgrade, Athens and Ghent	226
7.3.2 Restoration, renovation, reconstruction: reoperationalisation	234
7.4 Live from Studio 6	240
7.4.1 <i>Radio Concerto No 1</i> and mediatized visual cultures of live electronic music	240
7.4.2 Uses of liveness.....	246
7.5 Conclusion	251
Chapter 8	259
Conclusion: Possible futures	259
8.1 Constructing histories of electronic musicking.....	259
8.2 Back to the studio	261
8.3 The Synthi 100 and new, curious organologies of electronic music..	263
8.4 Possible futures	269

8.5 Reconstruction and writing	271
References and Bibliography	275
Bibliography	275
TV and radio broadcasts	293
Filmography	294
Discography	294
Public Records	295
Archives.....	295
Selected online archives, companies and composer/practitioner websites ...	296
Interviews and correspondence	297
Acknowledgements	298

List of Illustrations

Chapter 1

Figure 1.1 EMS, c.1974. Promotional photograph showing the Synthi 100 (right) and PDP8 computers (centre). Source: emssynthesisers.co.uk

Figure 1.2 EMS advert, c.1974-5. Source: Science Museum Archive

Figure 1.3 EMS advert, c.1973. Source: Science Museum Archive

Figure 1.4 Compilation of music from Cybernetic Serendipity, 1968. Cover image is graphic score of *January Tensions* by Peter Zinovieff. Source: cyberneticserendipity.net

Chapter 2

Figure 2.2 Programme for Unit Delta Plus Concert of Electronic Music, 1966. Source: Delia Derbyshire Archive

Figure 2.2 Programme for the Computer Arts Society's Event One, Royal College of Art, 1969. Source: Science Museum Archive

Figure 2.3 Programme cover for a Redcliffe Concert of Electronic Music, 1968 or 9. Source: Science Museum Archive

Chapter 3

Figure 3.1 EMS, 1971, soon after the move from the garden studio to the house. Source: emssynthesisers.co.uk

Figure 3.2 Peter Zinovieff with teletype and PDP-8/S, c.1968. Source: unknown

Figure 3.3 An excerpt from the MUSYS program, 1969–70. Source: Peter Grogono

Chapter 4

Figure 4.1 Page from VCS3 manual showing a ring modulator patch. Source: Science Museum Archive

Figure 4.2 EMS price list, 1973. Source: Science Museum Archive

Figure 4.3 VCS3 advert, *Studio Sound*, 1971. Source: worldradiohistory.com

Figure 4.4 EMS stand at Association of Public Address Engineers conference, 1971. Source: worldradiohistory.com

Figure 4.5 Synthi 100 brochure, c.1972. Source: Science Museum Archive

Chapter 5

Figure 5.1 Malcolm Clarke with the Delaware, BBC Radiophonic Workshop, 1974. Source: BBC

Figure 5.2 Stage set up for the Institute of Electrical Engineers event, The Radiophonic Workshop in Concert, Royal Festival Hall, London, May 1971. Source: Delia Derbyshire Archive

Figure 5.3 EMS Sequencer 256 information sheet, mid-1970s. Source: Science Museum Archive

Chapter 6

Figure 6.1 From left: Vladan Radovanović, Paul Pignon, Zorana Hrašovec and Milan Orlic, Radio Belgrade Electronic Studio, 1972. Source: RTS

Figure 6.2 Vladan Radovanović, early 1970s. Source: RTS

Figure 6.3 Paul Pignon teaching a class in the Electronic Studio, mid-1970s. From inner sleeve of *Elektronski Studio Radio Beograda* LP, 1977. Source: RTS/PGP

Figure 6.4 Various artists, *Elektronski Studio Radio Beograda* LP, 1977. Source: RTS/PGP

Chapter 7

Figure 7.1 Jari Suominen and Daniel Araya fixing the Synthi 100 at Radio Belgrade, 2018. Source: Svetlana Maraš

Figure 7.2 Paul Pignon giving a workshop at the re-opened Electronic Studio, 2018. Source: Svetlana Maraš

Figure 7.3 Marinos Koutsomichalis performing at Documenta 14, 2017. Source: Stathis Mamalakis / Marinos Koutsomichalis

Figure 7.4 Paul Pignon performing on *Concerts from Studio 6*, 2018. Source: RTS

Figure 7.5 Svetlana Maraš playing the Synthi 100 in the Electronic Studio, as a live feed on *Concerts from Studio 6*, 2018. Source: RTS

Chapter 8

Figure 8.1 EMS VCS 4, Goldsmiths, University of London, 2019. Source: Frances Morgan

Figure 8.2 Detail from Tom Carpenter's Synthi 100, 2016. Source: Frances Morgan

Chapter 1

Introduction: Electronic Music and Histories of the Studio

1.1. Introduction

How can histories of electronic music be constructed through locations, practices, devices and technologies? I address this question via an account of the origins, activities and inventions of a sound studio and electronic instrument company called Electronic Music Studios (EMS), which was founded in London in the late 1960s by the technologist and composer Peter Zinovieff. The story of EMS, which as a manufacturing company was known as EMS London Limited, intersects with numerous other narratives including the beginnings of the synthesizer industry in the 1970s; the early history of computer music; the rise of the institutional electronic music studio; the emergence of a cultural awareness of electronic music in the UK and Europe; and the historicisation of electronic music in the present day, as well as impacting upon and being influenced by developments in cultural, media and technical-scientific areas such as broadcasting, art, telecommunications and education.

Combining archival research with readings from media theory, philosophy of technology and science and technology studies, I propose that approaching electronic music histories through a focus on media and technology addresses some of the challenges faced by musicologists when writing histories of electronic music and sound and attempting to engage with the musical-technological past.

One of the earliest centres of computer-controlled music in the world, EMS occupies an important place in the history of music and computing. I examine the role of the computer in musical composition and other art forms in the late 1960s and early 1970s, and ask how perceptions of computers in music affected the work that took place at EMS.

As an instrument manufacturer, EMS is best known for its VCS3, a small, portable analogue synthesizer launched in 1969. In my study, I choose to focus mainly on the Synthi 100, a large hybrid digital/analogue synthesizer developed by EMS in

1970–71. I chart the development of this electronic instrument from its invention to its rehabilitation in the present day and, through looking at a recent project to restore a Synthi 100, consider the ways in which the instrument has been used, perceived and publicly presented. In documenting how the Synthi 100 was acquired and used in two different studios, one in the UK and one in the former Yugoslavia, I suggest parallels between EMS's activities as a studio and as a manufacturer of instruments, drawing connections between these two strands of activity that have often been portrayed as separate: firstly, by considering the ways in which a synthesizer can be conceptualized as a studio in itself; and secondly, by emphasising the centrality of EMS instruments to electronic music studio cultures in the 1970s.

The wider question of how electronic music is historicised is addressed within the context of a growing number of histories of electronic music that focus on the studio as a site for making electronic music. In this chapter I provide a brief synopsis of EMS's origins and key activities. I then present a short survey of current literature on electronic music studios, an area which has increased in recent years, to the point where it could be seen as a discrete area of study within ethnomusicology or historical musicology. The development of this field has corresponded with a turn towards material cultures and practice-based research in studies of electronic music, as well as overlapping with Media Studies-based research into histories of 'media labs' and communications technologies.¹ I locate what it is about the electronic music studio as a location that appeals to researchers, and ask what possibilities it can bring to our understanding of electronic musical works, as well as charting its appeal in non-academic cultures of electronic music. Finally, I propose a multi-locational, dispersed model of the studio-focused research project that contributes towards an understanding of electronic music studio cultures as a distinct and important element within wider cultures of electronic music and sound.

¹ In their ongoing research into the history of the 'media lab', a semi-autonomous institutional space in which experiments in a variety of media are carried out, Wershler, Parikka and Emerson chart the ways in which audio as well as visual and other media technologies can, via this experimental setting, be put to multiple uses and reach a variety of destinations; we could say that some of the devices and practices developed in the experimental environment of an electronic music studio have a similar potential for dispersal and reappropriation. See <https://whatisamedialab.com/>

1.2. A note on electronic music

It is important at this early stage to define what I mean by the term ‘electronic music’ in this study. This is a term that has been and continues to be understood differently across a variety of disciplinary fields and from a variety of perspectives including technical, cultural and aesthetic. In *Understanding the Art of Sound Organisation*, Leigh Landy notes that when the term electronic music originated in the 1950s it generally referred to music that has been ‘uniquely generated electronically’, using devices such as oscillators, as opposed to music made from pre-recorded sounds (musique concrète). Since then, however, it has often been used synonymously with ‘electroacoustic music’, a useful umbrella term that incorporates a number of approaches to define ‘any music in which electricity has had some involvement in sound registration and/or production other than that of simple microphone recording or amplification’.²

But Landy’s definition of electroacoustic music, while clear, concise and widely applicable, referring as it does to process and materials rather than music’s aesthetic and cultural status, does not take into account the fact that electroacoustic music, as a descriptor, has itself come to have distinct cultural and academic associations, being historically and geographically associated with a fairly small group of twentieth century British, French and Canadian composers.³ It is partly for this reason that I have used the term ‘electronic music’ rather than ‘electroacoustic music’ throughout this study, although I use it in a similar way, allowing ‘electronic music’ to be an umbrella term that takes into account the production of music with tape or musique concrète techniques, computers and electronic musical instruments, which is disseminated via performance, radio broadcast and recorded media. However, while using this wide-ranging term to describe a range of methods and processes, I am also, in this study, aligning it with a narrow historical and geographical area of music and musical culture, within the wider field that we might understand as being defined technically and materially as electronic music. Therefore I am often aware of a tension between inclusivity and specificity when discussing my work, as I explain below.

² Leigh Landy, *Understanding the Art of Sound Organisation*, (Cambridge, Mass: MIT Press, 2007), p. 13.

³ As outlined in Simon Emmerson (ed.), *The Language of Electroacoustic Music* (London: Macmillan, 1986).

Before beginning this project, I was aware of some of the long-running debates around definitions of electronic music from within the field;⁴ and, as a popular music critic, I am used to contentious discussions about genre, taxonomies, and who or what represents certain musics the best. Yet I was struck by the readiness with which people enthusiastically offered their own ideas of what electronic music in the 1970s ‘was’ when asking me about my research. While I enjoyed the conversations that arose – about Kraftwerk, Tonto’s Expanding Headband, Wendy Carlos’s *Switched-On Bach*, and much more – the point would come at which I would try to explain that I was working on something different. But how should I explain this difference without using terminology that would imply a qualitative comparison with the popular music we had been talking about – in many cases, music with which I am strongly aligned?

Terms such as, for example, ‘art music’, ‘academic music’ or ‘electronic composition’, or the less specific ‘avant-garde’ or ‘experimental’, carry with them an implication that popular electronic music is not artful or composed, nor does it have any intellectual, experimental or avant-garde qualities.⁵ The notion of ‘serious’ music, stemming from the German ‘E-musik’ (with E standing for ‘ernst’, or ‘serious’), is, while I understand it to refer to a certain music’s role within society (in contrast to U-Musik, referring to ‘unterhaltung’, or ‘entertainment’ music) has equally problematic connotations, in English at least. It is also not exactly correct, as a small part of this study focuses on the use of electronic music in TV and radio soundtracks and dramas,

⁴ See Robin Heifetz (ed.), *On the Wires of our Nerves* (Cranbury, NJ: Associated University Presses, 1989); Peter Manning, *Electronic and Computer music*, 4th edn. (Oxford: Oxford University Press, 2013); Joanna Demers, *Listening Through the Noise: the Aesthetics of Experimental Rlectronic Music* (Oxford: Oxford University Press, 2010); Curtis Roads, *Composing Electronic Music: A New Aesthetic* (Oxford: Oxford University Press, 2015); Thom Holmes, *Electronic and Experimental Music: Technology, Music, and Culture*. (Routledge: New York/Abingdon, 2016); and others.

⁵ Joanna Demers uses the term ‘experimental’ very effectively in *Listening Through the Noise*, which covers various historical and present day movements in electronic music. However the historical context of my study – the late 1960s to 1980s, mostly in the UK – makes me wary of using this term. Following Michael Nyman’s *Experimental Music: Cage and Beyond* (Littlehampton : Littlehampton Book Services Ltd, 1974), the term ‘experimental’ has become associated in historical studies of music with a cluster of North American and British musical movements or tendencies dating from 1959 to the 1970s, including minimalism, indeterminacy, and connections with visual art, with electronic music playing a small role in this discourse. *The Experimental Music Catalogue*, established in 1969 by Christopher Hobbs (see <http://experimentalmusic.co.uk/>), further refined an idea of experimental music as not so much a description of tendencies but a school consisting mainly of British composers including Cornelius Cardew, Gavin Bryars and Hobbs and Nyman themselves. For those reasons, while I might use the term ‘experimental’ in everyday speech to describe the music associated with EMS, it would be inaccurate to define it as such in the context of British music of the 1970s.

which would, by those definitions, be classed either as ‘entertainment music’ or in another category of ‘functional music’.

In conversation, struggling to explain, I often alight on the term ‘classical electronic music’, which is in some ways the worst one to have chosen – not only is it just as elitist as the others I have mentioned, it is also musically inaccurate – yet it also seems to say the most, suggesting that certain cultural terms have a connotative power beyond their precise meaning. Certainly, this study predominantly concerns *institutions* of classical music and other ‘high cultural’ art forms, and explores the position of electronic music in relation to these institutions.

However, as I outline later in this chapter, too, the popularity of historical electronic art music composed in institutional studios within modern subcultures of electronic music complicates these binaries of high/popular, serious/entertainment, and so on. This complexity can also be seen in the subcultures, identified by Joanna Demers, of experimental popular electronic music such as microsound, noise and glitch, which share many aspects in common with electroacoustic music.⁶ In part, it is from within those subcultures – which, in my work as a popular music critic, I have often addressed – that this study has emerged. This goes some way to explaining why I have chosen to focus not on the use of EMS’s instruments by rock musicians of the 1970s, nor even their use in the ‘mixed avant-garde’ proposed by Benjamin Piekut⁷ but primarily on the culture of the institutional/academic electronic music studio and the works produced there.

Often I will shift the conversation from music to machines, stating that I am researching the technology of historical electronic music studios. This is not a new response to the problem of what constitutes electronic music. In 1983, Allen Strange, in the introduction to the second edition of his sourcebook on electronic music, paints a picture of a hypothetical ‘Electronic Music’ rack at the record store, which contains John Cage, Milton Babbitt, Herbie Hancock, the Sonic Arts Union and many others: ‘I am sure this bin has grown significantly since this text went to the printer’, he remarks, and notes that, with such a variety of musics being called ‘electronic’, the term ‘cannot possibly refer to any single aesthetic production’. His solution is to focus

⁶ Demers, *Listening Through the Noise*.

⁷ Benjamin Piekut, ‘Indeterminacy, free improvisation and the mixed avant-garde: experimental music in London: 1965-75’, *Journal of the American Musicological Society*, 67:3 (2014), pp. 769-824.

primarily on ‘*instrumentation and orchestration*’: looking at the ‘how’ rather than the ‘why’.⁸

However, Strange’s book is written for musicians, rather than being a cultural-historical study. The fact that I choose to focus on instruments and technologies over analysis of musical types and genres does not mean that the ways in which electronic musics have been culturally positioned, defined, listened to and understood are not also of fundamental importance; these areas are co-constitutive of one another. The aims, actions and ambitions of the people who set up studios and companies such as EMS, designed and built electronic instruments, and composed music for them, were rooted in contemporary attitudes about music, art, science and technology; these attitudes similarly affected audience responses to electronic music, institutional support and funding for it, and many other aspects of what we now might term historical electronic music. While the term ‘electronic music’ might in the present day describe a multitude of practices and aesthetics, therefore, it is important to remember what it has meant in the past, to the informants who contributed to this study, and within the social and cultural milieus in which they operated.

To conclude, I use the term ‘electronic music’ throughout this study as, firstly, a simple and straightforward way of describing what is done in an electronic music studio, and, secondly, because it is the term most suited to the historical context in which I am working, and the one used most often in the primary sources that inform my research.

1.3. A brief history of EMS

1.3.1 EMS: a London studio?

What was – and is – EMS? This is a question that recurs in various ways throughout this study, as I trace the origins of the studio and the company that bear this name. For many musicians, the name EMS is immediately associated with a synthesizer: the EMS VCS3. This portable voltage-controlled analogue synthesizer was first manufactured in 1969 and became EMS London Ltd’s most widely sold product. However, EMS was also the name of a studio used for the composition and production of electronic music as well as research into sound synthesis and computer-controlled

⁸ Allen Strange, *Electronic Music: Systems, Techniques, and Controls*. 2nd edn. (Dubuque, Iowa: W.C. Brown, 1983). Emphasis in original.

composition: a space of musical and technological experimentation that, for a short time, housed one of the most advanced hybrid analogue-digital synthesis systems in the world.⁹ The aim of the manufacturing company was primarily to support the studio, through sales of synthesizers and other devices. Therefore, while the studio and manufacturing activities of EMS were closely related and interdependent, at the same time there were tensions between these two aspects of the organisation which have been further amplified in historical accounts of EMS. I explore this dynamic, and its historicisation, in Chapter Four.

Both the studio and the manufacturing company were established by Peter Zinovieff, a British born scientist and composer of aristocratic Russian parentage whose background included a doctorate in geology from Oxford University and a short period of working as a mathematician in the civil service, and who had become interested in the potential of computers for composing and performing music.¹⁰ Zinovieff had been experimenting with home studio set-ups since the mid-1960s, working with an engineer, Mark Dowson, to build devices with which he could make music using computational methods such as sequencing. As Zinovieff's interest in electronic music developed, he began to make connections with other like-minded composers, curators, engineers and artists, including composers Tristram Cary and Harrison Birtwistle, computer programmer Alan Sutcliffe and BBC Radiophonic Workshop producers Delia Derbyshire and Brian Hodgson. In Chapter Two, I describe how these connections led to activities across various cultural, social and professional milieus within London, including art, science and computing as well as contemporary music, all of which influenced the nature and aims of EMS as it developed both as a studio and as a synthesizer manufacturer.

By 1969, Zinovieff had established a studio at his home at 49 Deodar Road in Putney, South West London large enough to accommodate a range of equipment that included a PDP-8/S, one of the early minicomputers built by the US-based Digital Equipment Corporation. This PDP-8/S was soon joined by another model from the same range, a PDP-8/L, and a hybrid synthesis system known as MUSYS was constructed by Zinovieff and another engineer, David Cockerell, who designed and

⁹ Peter Manning, *Electronic and Computer Music*, 4th edn. (Oxford: Oxford University Press, 2013), pp. 236–7.

¹⁰ Trevor Pinch and Frank Trocco, *Analog Days: the Invention and Impact of the Moog Synthesizer* (Cambridge, MA: Harvard University Press, 2002), p. 267; Norma Beecroft, *Conversations with post-World War II Pioneers of Electronic Music* (Toronto: Canadian Music Centre, 2016), p. 369.

built much of the equipment that enabled this system to work, with a programmer, Peter Grogono, commissioned to write the software for it. In order to sustain this studio, which was extremely costly to set up and run, Zinovieff and his colleagues began to manufacture and sell synthesizers, starting with the VCS3.

When EMS London Ltd was established as a company in 1969, Cockerell, as the chief engineer and designer of its devices, was also one of its directors. As the company grew, Cockerell set up a workshop in Cricklewood Lane, near where he lived in North West London, and worked primarily from there. A public-facing EMS shop, where customers could order their synthesizers or bring them in for repair, was run from 177 Putney Bridge Road, near the studio, while the devices themselves were assembled by a subsidiary company of EMS, Hilton Electronics, which ran a small factory in Wareham, Dorset. A small network of foreign distributors of EMS products ran their own operations in other cities, one of the most active being the German distributor Ludwig Rehberg, who was based in Stuttgart but was a frequent visitor to London, staying above the shop at Putney Bridge Road when he was in town. On various publicity materials from the 1970s, a New York address for 'EMS Inc' was given alongside the London one, indicating the company's intentions to sell products to the US market.¹¹

As this brief sketch indicates, then, the 'where' of EMS encompassed a number of physical locations aside from the official studio address of 49 Deodar Road. This itself turned out to be a fairly short-lived base, as in 1976 Zinovieff sold the London property and moved both household and studio to a former priory in the village of Great Milton, in Oxfordshire.¹² This remained the company's address until, in December 1979, it went into receivership due insolvency.¹³

This picture of the various locations associated with EMS serves to immediately differentiate it from the institutional electronic music studios that I will describe later in this chapter, and throughout the study. While EMS shared some of the concerns of the kinds of composition- and research-focused studios being set up in the 1960s and 1970s by universities or telecommunications companies, such as Stanford University's Centre for Computer Music Research and Acoustics (CCRMA) or Max Mathews's computer music studio at Bell Laboratories, or those housed at or financed by a

¹¹ MS/2160: Concert Programmes, Alan Sutcliffe Archive, Science Museum.

¹² William Buxton, *Computer Music: A Directory to Current Work* (Ottawa: UNESCO Commission, 1977), p. 74.

¹³ Recorded in *The Gazette* (London), 20 December 1979 (48036), p. 16112.

national broadcaster, like Milan's Studio di Fonologia, which was based at the Italian TV and radio station RAI, it combined these with the demands of a commercial synthesizer company along the lines of contemporary North American manufacturers such as ARP and Moog. As a small limited company and private studio, it was, compared with most other centres of electronic music, vulnerable to the vagaries of national and international markets, investors, property values and other commercial factors. Yet we will also see that this measure of independence allowed EMS to take risks, develop ambitious products and operate in unorthodox ways, allowing for the formation of new professional roles as well as new instruments and practices. The studio was not at the mercy of the fluctuations in institutional funding that affected other studios of the same period, as I outline in my case studies of the BBC Radiophonic Workshop and the Radio Belgrade Electronic Studio in Chapters Five and Six. However, its independence from institutions also meant that EMS had to be outward-facing and entrepreneurial; for example, engaging with the media, creating advertising campaigns and, in its early days, organising concerts that would also serve as publicity for Zinovieff's studio and EMS products. These events, articles, appearances and adverts cultivated a public image that, as I outline below, persists into characterizations of EMS in the present day. Its identity as a London-based studio was part of that public image.

The public image of EMS in the early 1970s was a studio with a salon-like setting, with a publicity photograph showing an elegant room with large arched windows, framed paintings on the wall and a polished wooden floor, and a doorway leading to a specific listening room for demonstrations and playback of compositions (see Fig.1). This, and the local aspect of the EMS synthesizers – for some years the only European-made synthesizers on the market – were points of interest that were picked up on by the media. Some of these portrayals could be reductive. For example, before creating the studio mentioned above (which was achieved by buying the house adjoining number 49 and knocking through the walls),¹⁴ Zinovieff initially installed his computer-controlled system in a purpose-built studio in the garden. This building, which had been designed by architect Nicholas Dumbleby,¹⁵ was described as a 'garden shed' in a Pathé newsreel feature in 1968. The voiceover introduced Peter

¹⁴ Hugo Cole, 'He doesn't advance cautiously...' [profile of Peter Zinovieff]. *Guardian*, 15 January, 1973.

¹⁵ James Gardner, 'Even Orpheus needs a Synthesizer', *Tempo* 70 (2016), p. 57.

Zinovieff as a man with ‘a hobby that’s strictly for boffins’.¹⁶ This belied Zinovieff’s seriousness about his work, as well as downplaying the significance of the computer itself. The first computer to be installed in a private home in the UK, it represented a major investment for Zinovieff, and he regarded it as far more than a hobby.

As James Gardner has noted, media coverage of EMS both in the late 1960s and in the present day has often relied on a number of stereotypes of middle and upper class domesticity, British eccentricity, and a kind of ‘mad scientist’ ingenuity: ‘A Very British Adventure – a kind of *Carry On Synthesising*’, as he puts it.¹⁷ Yet EMS’s founders also used such stereotypes knowingly and cleverly in the company’s marketing and publicity. A series of EMS London Ltd’s magazine adverts from the early 1970s, taking the mundane ‘Every home needs a...’ slogan to absurd lengths, recast the synthesizer as an essential item for the switched-on modern family, proclaiming, tongue in cheek, that ‘Every picnic needs a Synthi’. The image for this last advert showed Zinovieff with assorted family members and friends on holiday at his summer base on the Scottish island of Raasay; Zinovieff, wearing a kilt, plays a DK1 – a keyboard controller for the VCS3 – while a Synthi A (a more portable version of the VCS3) lies in the grass next to a beached boat, connected to an electricity generator (Fig.2). The “Every band needs a Synthi” advert, meanwhile, showed not a rock band, but that quintessentially provincial British group, the brass band (Fig.3). However, while the adverts described above have become well-known, EMS’s advertising adopted different visual styles depending on the intended audience. An ‘Every concert needs...’ advert, which may have been designed for a concert programme, has a pop art aesthetic, with a collage showing a large orange fingertip pressing an ‘EMS’ button. More sober adverts placed in audio-technical magazines were aimed at professional sound studios; and approachable, brightly coloured leaflets showing the ‘Synthi Family’ and using handwritten text, tried to capture the educational market.

The visual style and vocabulary of EMS’s adverts are the products of what is commonly understood as a vibrant period from the 1950s to the 1970s in which postwar social, political and economic developments increased access to arts and cultural activities for many people, while the tropes and techniques of the mass media had become familiar enough to be ironised in art, and, eventually, in the media

¹⁶ *Computer Orchestra* (British Pathé, 1968).

¹⁷ Gardner, ‘Even Orpheus Needs a Synthi’, p. 57.

themselves. London, as a centre of art, architecture, design and media, as well as pop music, fashion and other cultural forms, was a context in which such an approach to visual promotion was familiar and even expected. However, although it is true that EMS was founded in London during the 1960s, it is important that tropes of ‘1960s London’ do not become the only perspectives through which we understand EMS. As an organisation and as a collection of individuals, EMS both contributed to and stood apart from various cultural movements taking place during its development. For example, aside from pop music, television and radio having created a new market for electronic instruments which his company could sell, Zinovieff was not particularly invested in the ‘smuggling’ (as Mark Brend characterises it in his book *The Sound of Tomorrow*)¹⁸ of electronic sounds into mainstream consciousness. Of more interest to Zinovieff than enhancing generic music with unusual sounds was the coincidence of new ideas in composition and new possibilities in technology that indicated that the processes of making music, and music itself, could be radically changed.

1.3.2 Cybernetics, computers and ‘inspirational’ compositions

EMS was founded during a time of important developments not only in music and arts but also in science and technology; and, crucially, during a period of increased dialogue between these areas. A well-known and increasingly well-documented¹⁹ manifestation of this was Cybernetic Serendipity, an exhibition held in 1968 at the Institute of Contemporary Arts (ICA) in London, which showcased artworks and other objects that were informed by the theories of information and feedback within and between both biological and machine-based systems that had been defined by Norbert Wiener in 1948 as cybernetics;²⁰ two examples given in the exhibition programme are ‘remote control robots and painting machines’.²¹ Curated by critic Jasia Reichardt and with EMS’s first engineer Mark Dowson as its advisor, Cybernetic Serendipity’s

¹⁸ Mark Brend, *The Sound of Tomorrow: How Electronic Music Was Smuggled Into the Mainstream*. (London: Continuum, 2012).

¹⁹ Examples of this include a 2014 exhibition at the ICA, London, of archival materials relating to the 1968 exhibition; archival materials included at Whitechapel Gallery, London’s Electronic Superhighway exhibition (2016), and a 2018 symposium, Cybernetic Serendipity Reimagined, at the University of Liverpool, as part of the Convention of the Society for the Study of Artificial Intelligence and Simulation of Behaviour (AISB 2018).

²⁰ Norbert Wiener, *Cybernetics: or, Control and Communication in the Animal and the Machine* (New York: John Wiley & Sons, 1948).

²¹ Jasia Reichardt (ed.), *Cybernetic Serendipity: The Computer and the Arts*. (Studio International special edition, 1968), p. 5.

exhibits included computer generated poetry and light and sound sculptures, and for a short period of the exhibition visitors were able to see Zinovieff's PDP-8/S computer, which he had lent to the ICA.²²

The popularity of cybernetic thought in the visual arts and arts education, as described by Catherine Mason in *A Computer in the Art Room: the Origins of British Computer Art*, extended, for a short time, an invitation to those working with electronic music and sound to participate in a new multi-disciplinary milieu, as I propose in Chapter Two by situating the founders of EMS in the context of developments in contemporary concert music, kinetic and media art, music education and early computer arts in the mid- to late-1960s. While the connections made within and across these groups were often brief and circumscribed by ideas of disciplinary and cultural boundaries, Cybernetic Serendipity and other artistic-scientific initiatives taking place in London, such as the formation, in 1969, of the Computer Arts Society, nonetheless played a part in establishing the cultural and technical conditions under which EMS, both as a studio and an instrument manufacturing company, was formed.

In 1969, Zinovieff wrote in *The London Magazine* of his vision for an 'inspirational computer music', in which he expressed the possibility that a computer could be a 'good interpretive agent' of music; in other words, that a computer can not only perform but also compose – in a kind of collaboration with its human operator – highly complex, original music.²³ The adjective 'inspirational' in Zinovieff's essay does not refer to the common usage of the term to mean spurring a person into action by means of a revelatory example; instead, here it is interchangeable with, although not quite the same as, describing music as 'intuitive' or, more commonly, 'indeterminate'. For music to be inspirational in this sense, it need not be electronic or computer-generated: performing a John Cage or Earle Brown score could be described in similar terms. Here, 'inspiration' is akin to the use of indeterminacy as a means of destabilizing or complicating the relationship between composer and performer, a practice that significantly informed the postwar musical avant-garde in the US and to a lesser extent the UK. Zinovieff's article, which includes two of his graphic scores,

²² Catherine Mason, *A Computer in the Art Room: The Origins of British Computer Arts 1950-1980*. (London: Quiller Press, 2008); Brent Macgregor, 'Cybernetic Serendipity Revisited', *Proceedings of the 4th Conference on Creativity and Cognition* (New York: ACM, 2002). The cover of a record produced to accompany the exhibition, showing a graphic score by Peter Zinovieff, can be seen in Fig. 1.4.

²³ Peter Zinovieff 'The Special Case of Inspirational Computer Music Scores', *The London Magazine*, 4: 9 (1969), p. 167.

hints that he was aware of these currents, but for him the way to achieve these aims was through the studio that he had recently established, and which he describes as having ‘great potential’.²⁴ The use of electronic instruments could allow for randomisation both literally, in the case of a computer algorithm that produces random values between specified parameters, and more figuratively, in machine-generated phenomena such as feedback, or unexpected sonic results of the digital analysis and transformation of recorded sounds. In his article Zinovieff proposes a scenario which a computer can interpret scores with the same precision and emotional sensitivity as a human performer; and a composer and a computer can meaningfully work together to co-create music.

The composer with whom Zinovieff formed the most productive relationship at EMS was not a member of Piekut’s Cage-influenced ‘mixed avant-garde’ but Harrison Birtwistle, who was more closely associated with a school of British Modernist composition originating in the 1950s.²⁵ As Tom Hall notes, the two had a number of shared areas of interest. By the time Birtwistle and Zinovieff met in 1968, Birtwistle had been fascinated by random processes for some years, using a list of computer-generated random numbers to generate ideas for compositions.²⁶ Both men were also deeply interested in the topics of mythology and time, themes that would surface in a number of works in the 1970s and culminated in the opera *The Mask of Orpheus*, which explores the nature, perception and representation of time through the Orpheus myth. The opera, for which Zinovieff wrote a highly complex libretto that requires singers to learn a new language, was an ongoing project throughout the 1970s and early 80s which Birtwistle and Zinovieff worked on amongst their other concerns.²⁷ It was finally performed in 1986 by the English National Opera, with electronic elements created at IRCAM, Paris, by the composer Barry Anderson.²⁸

²⁴ Ibid., p. 169.

²⁵ See Philip Rupprecht, *British Musical Modernism: the Manchester Group and their Contemporaries* (Cambridge: Cambridge University Press, 2015).

²⁶ Tom Hall, ‘Before *The Mask*: Birtwistle’s electronic music collaborations with Peter Zinovieff’, in *Harrison Birtwistle Studies*, ed. by D. Beard, K. Gloag, and N. Jones (Cambridge: Cambridge University Press, 2015), p. 67.

²⁷ In the radio documentary *Peter Zinovieff*, the impression given by former colleague Alan Sutcliffe, interviewed for the programme, is that *The Mask of Orpheus* was a consuming project that Zinovieff focused on to the detriment of running his company. *Peter Zinovieff*, Matthew Fowler (Producer), Katrina Porteous (Writer/Presenter). UK: BBC Radio 4, 14 June, 2004.

²⁸ Harrison Birtwistle (libretto Peter Zinovieff), *The Mask of Orpheus* (Universal Edition, 1986); For accounts of *The Mask of Orpheus*, see David Beard, *Harrison*

I will return to Birtwistle and Zinovieff's early collaborations in Chapter Three, as I give an account of the early years of EMS's computer-controlled studio, as well as situating EMS in an international context of computer music through an account of the 1971 UNESCO Conference on Art and Technology. Rather than analysing Birtwistle and Zinovieff's compositions, I use the fact of their collaboration as a means of considering the shifting roles of composer, producer/realisateur, programmer and performer in early iterations of computer music.

1.3.3 A national studio and international studio cultures

EMS's dual identity as both a small private research and composition studio and a manufacturing operation was not only unusual, it was also very hard to sustain, practically and financially. As Zinovieff wrote in 1976, due to the slow and painstaking process of making computer music at this time and the many things that can go wrong with a highly complex system consisting of many different devices, much of his working day was spent troubleshooting, debugging and doing other work to support the studio. In an article documenting five days at EMS in the summer of 1976 for *PAGE*, the Computer Arts Society's journal, he wrote,

...in this studio I dare say 10 times as much music could have been completed if we had not had floods [from a leaking roof], done programming, had to sell machines to support the salaries and developed sophisticated new hardware. [...] If it wasn't for the distractions and breakdowns then there would be an enormous output from the studio in musical terms.²⁹

Zinovieff had in fact come to this realisation some years earlier. From the late 1960s he, along with Tristram Cary and Harrison Birtwistle, had been campaigning for EMS to become the basis for a publicly supported 'national studio', an enterprise that Cary in particular had supported since at least 1966 in various writings and talks. As I describe in Chapter Two, Zinovieff and Cary made various attempts to gain support from music and arts bodies in the UK such as the Arts Council and the Society for the Promotion of New Music (SPNM), as well as concert societies such as the Redcliffe Concerts of British Music, who supported the well-received Concerts of Electronic

Birtwistle's operas and music theatre. Cambridge: Cambridge University Press, 2012) and Jonathan Cross, *Harrison Birtwistle: The Mask of Orpheus* (Farnham: Ashgate, 2009).

²⁹ Peter Zinovieff, 'From a Diary: Electronic Music', in *PAGE* 38 (1977), p. 2.

Music that Zinovieff and Cary put on at London's Queen Elizabeth Hall between 1968 and 1970. Between 1968 and 1971, the two EMS directors, with the help of Birtwistle, focused their efforts on trying to establish a national electronic music studio for Great Britain, proposing that the existing studio at Putney should become the basis for this. In 1969 Zinovieff and Birtwistle formed the British Society For Electronic Music (BSEM), and proposed a Plan For British Electronic Music to the Calouste-Gulbenkian Foundation in 1971.³⁰ Although this national studio was never established, the campaign by EMS's founders and their associates provides a useful perspective on the fluctuations in support for electronic music within new music and arts organisations and other bodies throughout the late 1960s and 1970s, which directly impacted upon the founding of EMS and the studio's later fortunes. Nicole Anne Candlish's thesis, *The Development of Resources for Electronic Music in the UK, with Particular Reference to the Bids to Establish a National Studio*, follows this campaign up until the late 1970s, and notes that right up until shortly before EMS's closure Zinovieff continued to advocate for this national institution.³¹ But while EMS itself never became the UK's national studio, it played an important role in enabling national electronic music studios to be established elsewhere, making electronic music technology available to students of music and engineering at numerous university and college music departments in the UK and Europe, and some in the US, Canada and Australia, many of whom bought EMS synthesizers during the 1970s.

The histories and cultures of electronic music studios and the manufacturing of electronic musical devices have been closely connected in many ways. Early synthesizers were designed with the new electronic music studios in mind, and synthesizer builders such as Robert Moog and Don Buchla worked closely with composers and the institutions with which they were associated, for example the San Francisco Tape Music Center, where Buchla worked with composer Morton Subotnick.³² In his study of the music technology industry, *Any Sound You Can Imagine*, Paul Théberge describes these collaborations between composers and technicians as 'critical relationships that helped define the very nature of the analogue

³⁰ Daphne Oram Archive 1/2/057: Calouste Gulbenkian; also Calouste Gulbenkian Foundation Archive. Oram was present at the 1971 meeting to discuss the plan for the national studio.

³¹ Nicole Anne Candlish, 'The Development of Resources for Electronic Music in the UK, with Particular Reference to the bids to establish a National Studio'. (unpublished doctoral thesis, University of Durham, 2012), p. 166.

³² See Bernstein (ed.), *The San Francisco Tape Music Center: 1960s Counterculture and the Avant-garde* (Berkeley: University of California Press, 2008).

voltage-controlled synthesizer during the 1960s'.³³ Because EMS was both a studio for composition and research and a commercial manufacturing company, this connection was both complicated and intensified. I argue that some of the philosophies of the EMS studio were implemented in EMS London Ltd's synthesizers and therefore in other studios. This is particularly persuasive in the case of the EMS Synthi 100, a large-scale analogue synthesizer with a built-in digital sequencer that was produced to order for a total of 30, mainly institutional studios between 1971 and 1979. Introducing the VCS3 and the Synthi 100 in Chapter Four, and through case studies of the BBC Radiophonic Workshop and the Electronic Studio at Radio Belgrade in Chapters Five and Six, I show how the Synthi 100 brought the ideas and philosophies of EMS into studios both nationally and internationally.

Throughout the 1970s EMS London Ltd continued to design and manufacture more instruments and devices that reflected the preoccupations of the studio. These included the Vocoder 2000 and 5000, the Spectron (a video synthesizer designed by Richard Monkhouse), the polyphonic Polysynthi, a Computer Synthi providing a computer interface for the Synthi 100, the Synthi E (a simplified version of the Synthi A designed for educational use) and various peripheral devices such as analogue-to-digital and digital-to-analogue converters, filter banks and a pitch-to-voltage converter.³⁴ After David Cockerell's departure from EMS in 1973, Peter Eastty and Tim Orr took on much of the design work for the company. Orr's Vocoder, which had originally been designed as an extra component for a Synthi 100 built for Westdeutscher Rundfunk, received praise from the BBC Radiophonic Workshop, with Geoffrey Manuel, the Head of Programme Operations, writing in a report dated 6 November 1976 that '...the Vocoder is a device so universal and so flexible that it will enable us to move forward in one big step and keep our position on the frontiers of sound exploration'.³⁵

Research into speech synthesis also drove a venture that preoccupied Zinovieff and his colleagues in the early 1970s – a telecommunications system using the voice analysis and synthesis techniques developed in the studio. This system, which was

³³ Paul Théberge, *Any Sound You Can Imagine: Making Music, Consuming Technology* (Hanover: Wesleyan University Press, 1997), p. 52.

³⁴ Peter Forrest, *The A-Z of Analogue Synthesizers* (Crediton: Susurreal, 1994), pp. 111–127; see also Chris Meigh-Andrews, 'Peter Donebauer, Richard Monkhouse and the development of the EMS Spectron and the Videokalos Image Processor', *Leonardo*, 40: 5 (2005), pp. 463–467 and Peter Zinovieff, 'EMS Milestones', *PAGE 69* (Spring 2013).

³⁵ BBC Written Archives, WAC R97/10/4 (Radiophonic Tech committee 1976-77).

named VOCOM, was seen to have enough potential for a new subsidiary company to be formed, called International Voice Movement (IVM), about which Zinovieff gave interviews to *The New Scientist* and *The Observer*.³⁶ However, the ambitious IVM venture – which would have required companies to invest in ‘Vocom units’ consisting of a computer, a digital oscillator, a data bank and other items³⁷ – failed through lack of investment and an unscrupulous colleague who had been relied upon to set up the project in the US.³⁸ In 1979, EMS went into receivership and its manufacturing operation was sold to a firm called Datanomics, which carried on making EMS products for a short period of time, including one final – and quite significantly altered – Synthi 100 that was made for Gabinete de Música Electroacústica in Cuenca, near Madrid.³⁹

1.3.4 Endings, new beginnings and alternative histories

After EMS closed down at the end of 1979, the studio’s remaining equipment was stored at the National Theatre, while Harrison Birtwistle was working there as Musical Director. According to Zinovieff and the National Theatre’s former Head of Music, Matthew Scott, only a few months after the equipment had been stored in a basement area behind the theatre’s sound stage it was irreparably damaged in a flood, making for a sad end to the innovative and ambitious company and studio.⁴⁰

Yet EMS has continued in various forms. Robin Wood, an engineer who joined EMS in 1971 and worked there throughout the company’s lifespan, took over the EMS name in 1995 and still operates as EMS from his home workshop in Cornwall, manufacturing and mending older EMS products such as the Soundbeam, an interactive device developed with the composer Edward Williams; Wood also still occasionally makes and sells VCS3s. Ludwig Rehberg, who was EMS’s German distributor throughout the 1970s, has since the 1980s run EMS-Rehberg from Stuttgart. In the last decade, virtual EMS instruments have been manufactured by companies including XILS, who released the XILS3, a VCS3 emulator, in 2010, and

³⁶ *New Scientist*, ‘Speaking Computer Saves Telephone Lines’, 22 February, 1973; Sydney Paulden, ‘The one that got away’, *Observer*, 8 April, 1973.

³⁷ Terence Mendoza, ‘VOCOM – An Entirely New Concept in Communications’, *Practical Electronics*, April 1973, pp. 15–17.

³⁸ Pinch and Trocco, *Analog Days*, p.287. Robin Wood, interview with author, 2018.

³⁹ Les Hayward, *A Short Autobiography* (self-published memoir, c.2005). See also *Electronics and Music Maker*, ‘Music Maker Equipment Scene’, November 1982. This Synthi 100 is also currently in the process of being restored by the FuzzyGab4 research group at Gabinete de Música Electroacústica. See <http://fuzzygab.uclm.es/>.

⁴⁰ Matthew Scott, Peter Zinovieff, interviews with author, 2016.

the record label Trunk, which released a VCS3 app for iOS, designed by Apesoft, in 2014.

Therefore, although we can say that a studio and a synthesizer manufacturer called EMS was established in 1969 and dissolved in 1979, it is only partially accurate to talk about EMS as an entity that existed only between these dates, when we take into account the temporary studios and workspaces that Peter Zinovieff set up prior to 1969, and the various manifestations of the synthesizer company that have existed since the 1980s. It is possible to see these points of ambiguity as an opportunity to reflect on the ways in which multiple influences form the spaces of electronic music, making it not always useful to impose a linear narrative on an account of a company, studio or instrument itself. For example, we might ask whether the Synthi 100 manufactured by Datanomics in the early 1980s, which used David Cockerell's original design but was heavily modified by engineer Les Hayward, is still an EMS product, or consider the status of reconstructed and modified EMS synthesizers, as well as thinking about the identity of a VCS3 emulation that can be played on a tablet or smartphone. What role do these devices and projects play in EMS's history, and do they encourage us to reconsider what an electronic music history includes or encompasses, as well as how it is constructed?

Thinking about these issues of modification, reconstruction and new virtual versions of EMS devices prompts us to take into account non-academic practices and approaches which, although they are integral to the historicisation of electronic music and the preservation of its technologies, are rarely considered in academic accounts of electronic music history; indeed, this study only touches upon them. Yet a growing body of non-academic research into the history of electronic music in the UK has been growing since the 1990s, with rock and electronic musicians such as Peter Kember, Richard James and Russell Haswell making contact with figures such as Peter Zinovieff, Delia Derbyshire and others, using old synthesizers in new musical works, and creating narratives around the people and technologies they consider to be historically significant. These narratives in turn affect their subjects. For example, Gardner states that the making of the 2006 documentary *What the Future Sounded Like* was one factor that contributed to Peter Zinovieff's emergence, in recent years, as

a composer – a designation he resisted earlier in his life – as well as a speaker, writer and authority on music technology.⁴¹

While Gardner is justifiably frustrated with what he considers to be badly realised archival projects, such as the release of a CD of Peter Zinovieff's music under the title *Electronic Calendar* on Peter Kember's Space Age Recordings label,⁴² there is also scope in exploring what we could call the 'fan culture' (cf. Matt Hills⁴³ and many others) of electronic music, examining rather than dismissing the 'zealotry' and 'hyperbole' that Gardner locates in Kember's sleeve notes to the CD.⁴⁴ Meanwhile the efforts of musicians, artists and researchers from a number of different musical communities and generations, as well as record labels (as I describe later in this chapter), synthesizer restorers and builders, and the online networks found on social media and forums such as Muff Wiggler⁴⁵ have all helped to generate an interest in stories such as that of the EMS Synthi 100. This, in turn, makes it more likely that ambitious reconstruction projects can be carried out with the support of universities, museums, broadcasters and other public bodies, as I describe in Chapter Seven. In Chapter Eight, I propose that a further study of the practices, philosophies and communities of reconstruction – and the way these intersect and interact with hacker and maker communities as well as record collector and music fan communities – would be of great value. Following Christopher Small's definition of 'musicking', which positions music as 'an activity by means of which we bring into existence a set of relationships that model the relationships of our world',⁴⁶ this study of EMS and the Synthi 100 begins to consider the ways in which current practices in music, art and archiving, both official and unofficial, influence how we perceive the music of the past.

⁴¹ Gardner, 'Even Orpheus Needs a Synthi', p. 56; *What the Future Sounded Like* (dir. Martin Bate, 2006).

⁴² Peter Zinovieff, *Electronic Calendar – The EMS Tapes* (Space Age Recordings, 2015).

⁴³ Matt Hills, *Fan Culture*. (London and New York: Routledge, 2002). I briefly address the issue of fan cultures of electronic music histories in 'Delian Modes: Listening for Delia Derbyshire in Histories of Electronic Dance Music', *Dancecult* 9:1 (2017), <https://doi.org/10.12801/1947-5403.2017.09.01.01>

⁴⁴ Gardner, 'Even Orpheus Needs a Synthi', p. 60.

⁴⁵ <http://www.muffwiggler.com/forum/>

⁴⁶ Christopher Small, *Musicking: The Meanings of Performing and Listening* (Hanover, NH: Wesleyan University Press, 1998), p. 18.

1.4 Background to this study

This study originated in a Collaborative Doctoral Partnership between the Royal College of Art and the Science Museum, who were seeking a researcher to work on a doctoral thesis about EMS. My study therefore began in response to this call. At the Royal College of Art, this thesis has been overseen by the Critical Writing in Art and Design programme in the School of Arts and Humanities, now called Writing. It is within this framework of critical writing that I have developed some of the media-theoretical readings and interpretations found in this study, as well as giving attention to media such as magazine articles, adverts and television programmes. The research environment of the RCA has also encouraged my interest in cybernetics and early computer arts. The context of the Science Museum has prompted readings in science and technology studies (STS) and sociology of science, material cultures, museum studies and much of the writing around scientific reconstruction that informs Chapter Seven of this study. Texts from musicology, philosophy of music and contextual fields such as ethnomusicology have informed my work, too, as well as the related field of organology, the study of musical instruments – itself an area that combines insights and methodologies from a number of different disciplines outside of music. However, the dual disciplines of writing and STS have had the strongest influence on some key theoretical and methodological decisions made during the writing of this thesis.

The first of these concerns the use in Chapters Five, Six and Seven, of Susan Leigh Star and James R. Griesemer's concept of the 'boundary object' in relation to the Synthi 100 and its use in two institutional electronic music studios. Star and Griesemer's theoretical framework explains how certain objects make 'many-to-many' networks possible in scientific, research and heritage environments, as outlined in their well-known study of a museum of natural history in California.⁴⁷ In applying the idea of boundary objects to electronic music studios and thus concentrating on the relationships between institutions, people, instruments, spaces and ideas, I outline two aims: firstly, to advance an idea of electronic music as an art form whose authorship is complicated and frequently collaborative, as I elaborate later in this chapter; and secondly, to explore how 'electronic music' as a practice and an idea has been known

⁴⁷ Susan Leigh Star and James R. Griesemer, 'Institutional Ecology, "Translations", and Boundary Objects: Amateurs and Professionals in Berkeley's Museum of Vertebrate Zoology, 1907–1939', *Social Studies of Science* 19 (1989), 387–420 (390).

and understood in the past, and how its history is known, understood, expressed and presented today.

The second of these decisions concerns the style in which musical compositions are written about, which is rooted in a responsive, descriptive practice developed through my work as a music critic and a tutor in Writing, specifically in writing on sound. This takes the place of the analysis of scores or spectrograms that one might expect in a musicological study. In part, this approach reflects my training as a writer about music for a specialist but non-academic audience. It can also be seen as a suggestion for an alternative way in which musical works that are primarily sound-based and which lack traditional scores, or indeed any score, can be usefully and critically described in a contextual, interdisciplinary study such as this, whose readers might be expected to have differing disciplinary backgrounds. This kind of descriptive writing is carried out in Chapter Three and more extensively in Chapter Six; I briefly develop the idea of ‘critical-sonic’ writing in my concluding chapter.

The case study of the Electronic Studio at Radio Belgrade in Chapter Six most visibly demonstrates both of these approaches. This case study should, therefore, be understood as a partial account of the Electronic Studio and its activities during the 1970s, rather than the result of extensive fieldwork and on-site archival research. The aim of the chapter is to provide a comparison with the BBC Radiophonic Workshop (described in Chapter Five); further explore the theoretical framework of the boundary object through looking at specific roles and relationships in the studio; and demonstrate, using descriptive techniques, how the principles underlying the Electronic Studio can be said to be demonstrated in some of the musical works created there. It also provides the historical context needed for the account of the reconstruction and re-presentation of the Synthi 100 in Chapter Seven. The scope and limitations of this study are further outlined in the introduction of Chapter Six.

1.5 Inside the electronic music studio: a survey of studio studies

Electronic music has always been dependent upon the availability of and access to technologies of electronic sound creation and reproduction. From the 1950s onwards these technologies were generally found in laboratories and studios which were, for the most part, housed within larger institutions such as universities, broadcasters,

telecommunications and engineering companies or record companies. At the same time, however, an amateur culture grew of electronic music making and invention, linked to existing communities of radio enthusiasts and amateur recordists (as documented by Ian Helliwell in his book *Tape Leaders*).⁴⁸ Private home studios owned by professional composers and producers, such as Pierre Henry's Studio Apsome in Paris, Daphne Oram's Tower Folly studio in rural Kent, and the studio in Fressingfield, Suffolk, that belonged to Tristram Cary, completed a growing network of spaces that could be described as electronic music studios. Composers also moved between these spaces within their own activities, working in institutional and private studios for different projects, or beginning a project in one location and completing it in another.

Even in its earliest iterations, the electronic music studio could not easily be defined outside of its very basic functions of the production and recording of electronic sound. In his *Répertoire International des Musiques Electroacoustiques / International Electronic Music Catalog*, a survey of electronic studios and works compiled in 1967 and published in English and French, the English composer Hugh Davies aimed to categorise as well as list the various kinds of studios that were emerging around the world. He devised a system of classification that marked studios as Permanent Private (PP), Permanent Official (PO), Improvised Private (ip) or Improvised Official (io), and listed works according to their purpose, such as 'concert', 'theatre', and so on.⁴⁹ Peter Zinovieff's previous enterprise before founding EMS, a studio-cum-production company called Unit Delta Plus, is listed as a 'permanent private' studio; EMS would have fallen into the same category.

Davies's attempt at taxonomising the production of electronic music will be unpacked in more detail in Chapter Two. His *Catalog* is an invaluable resource for anyone researching electronic music in the 1960s, yet it also, like all such catalogues and directories, can only provide a snapshot of activity and cannot account for the ways in which organisations can shift focus and activity. Not all private studios wished to remain private: as I noted earlier, EMS also had ambitions to become the basis of a public institution. A studio's staff, resources and even location could change

⁴⁸ Ian Helliwell, *Tape Leaders: a Compendium of Early British Electronic Music Composers* (Cambridge: Sound On Sound, 2016).

⁴⁹ Hugh Davies, *Répertoire International des Musiques Electroacoustiques / International Electronic Music Catalog*. (Paris & Trumansburg, NY: Groupe de Recherches Musicales de l'ORTF & Independent Electronic Music Center, Inc., 1968).

over time due to funding cuts or a change in institutional infrastructure; conversely, an officially recognised space could emerge out of an informal grouping of people and technologies. For example, in *The Sound of Innovation: Stanford and the Computer Music Revolution*, a study of Stanford University's Centre for Computer Research in Music and Acoustics (CCRMA), Andrew Nelson describes how, in the late 1960s, there were no facilities at Stanford for electronic music, nor was the university supportive of the aim of John Chowning – then a graduate student in music – to set up a studio, because of the high costs of specialist electronic music equipment. However, the engineering-focused university was well equipped with computers, which Chowning was able to access, meaning that,

In many ways, in fact, the roots of the Stanford computer music program would grow from repurposing nonmusical entities – equipment, programs, people and funding agencies – in the service of musical aims.⁵⁰

Chowning and his colleague Leland Smith had to become what Chowning described as 'tenacious parasites' of SAIL, the Stanford Artificial Intelligence Lab, before finally establishing CCRMA in 1974.⁵¹

The electronic music studio can therefore spring from a range of concerns and circumstances, and can change priorities and roles throughout its lifetime. The studio can be, among other things, a purpose-built space for producing sound effects for broadcast media; an organic, collective project that becomes formalised into an academic department; a research unit; a purely commercial endeavour; or a domestic room set aside for a hobby that becomes a profession. But however we understand the studio on an individual basis, the concept of the studio as a space for experimentation, composition and production is one that is essential to understanding the development of electronic music. The history of electronic music is, in part, the history of the studio, of the various people – ranging from composers and musicians to technicians, programmers and studio managers – who populated them, and of the larger structures in which they operated.

⁵⁰ Andrew Nelson, *The Sound of Innovation: Stanford and the Computer Music Revolution*. (Cambridge, MA: MIT Press, 2015), p. 25.

⁵¹ *Ibid*, pp. 30, 51.

In studies of popular music and the recording industry, the importance of the recording studio and its practices have been recognized in works such as Susan Schmidt Horning's *Chasing Sound: Technology, Culture, and the Art of Studio Recording from Edison to the LP* and Virgil Moorefield's *The Producer as Composer: Shaping the Sounds of Popular Music*, among many others.⁵² In popular culture, recording studios such as Abbey Road Studios in London, the Hitsville studios set up by Motown Records, and Muscle Shoals Sound Studio in Sheffield, Alabama, as well as numerous 'star' producers, are lauded for their role in the careers of famous bands or for establishing a certain kind of sound. In the study of electronic composition, although the names of particular centres of electronic music such as the studios of Westdeutscher Rundfunk in Cologne, and INA-GRM in Paris are well known – mainly through the composers associated with them, namely Karlheinz Stockhausen, Pierre Henry and Pierre Schaeffer – the possibilities of the studio itself as a conceptual framework and site of research have been slower to emerge.

However, there has been a rise in the last decade in books, dissertations and articles documenting the history of electronic music studios. As well as Nelson's book about CCRMA, these include accounts of Studio di Fonologia, Milan; Elektronmusikstudion, Stockholm; Philips Studio, Rotterdam; BBC Radiophonic Workshop; San Francisco Tape Music Center; Polish Radio Experimental Studio, University of East Anglia's Electroacoustic Studio; and Goldsmith's College Electronic Music Studio.⁵³ Many of these publications acknowledge a debt to Georgina Born's anthropological study of the Institut de Recherche et Coordination

⁵² Susan Schmidt Horning, *Chasing Sound: Technology, Culture, and the Art of Studio Recording from Edison to the LP* (Baltimore: Johns Hopkins University Press, 2011); Virgil Moorefield, *The Producer as Composer: Shaping the Sounds of Popular music* (Cambridge, Mass: MIT Press, 2005).

⁵³ John Dack and Maddalena Novati, *The Studio di Fonologia – a Musical Journey* (London: Ricordi, 2012); Sanne Krogh Groth, *Politics and Aesthetics in Electronic Music: a study of EMS – Elektronmusikstudion Stockholm, 1964-79* (Heidelberg: Kehrer, 2014); Kies Tazelaar, *On the Threshold of Beauty: Philips and the Origins of Electronic Music in The Netherlands, 1925–1965* (Rotterdam: nai010, 2012); Louis Niebur, *Special Sound: the Creation and Legacy of the BBC Radiophonic Workshop*. (Oxford: Oxford University Press, 2010), David Bernstein (ed.), *The San Francisco Tape Music Center: 1960s Counterculture and the Avant-garde* (Berkeley: University of California Press, 2008), David Crowley (ed.), *Ultra Sounds: The Sonic Art of Polish Radio Experimental Studio* (Heidelberg: Kehrer, 2019), Frances Morgan, 'Exploring the Early Development of the Electroacoustic Music Studio at University of East Anglia in the Context of a Historiography of Electronic Music' (unpublished MA thesis, Goldsmiths, University of London 2014); and Stephen Wilford, 'an Ethnographic Study of the Electronic Music Studios (EMS) in the Department of Music at Goldsmiths University' (unpublished MA thesis, Goldsmiths, University of London, 2011).

Acoustique/Musique (IRCAM), *Rationalizing Culture: IRCAM, Boulez, and the Institutionalization of the Musical Avant-garde*, an important work that I will discuss further in this chapter.⁵⁴

These studies take various forms, including full-length books, MA dissertations, catalogues of equipment (in the case of Novati and Dack's book on the Milan Studio di Fonologia), conference papers and short articles, and it is not my suggestion that they are all of equal depth or significance. However, they all contribute to a growing sphere of knowledge production around historical electronic music studios. Concurrently, through small record labels, blogs and other media associated with underground electronic music,⁵⁵ a small market has developed for recordings of 1960s and 70s electronic music associated with particular studios. Some of these releases are unofficial, driven by the enthusiasms of record collectors and user-generated online networks such as MP3 blogs and the Discogs website. A notable example of an unofficial commercial enterprise in this area was the now dormant Creel Pone bootleg label, which between 2005 and 2016 re-released on CD out-of-print records that had originally been released in small numbers by, for example, a university's in-house record label, a private press, or national broadcasters' labels (such as PGP RTB, the record label of Radio Television Belgrade, which housed the Radio Belgrade Electronic Studio that is the subject of Chapter Six). Others have resulted from – or developed into – relationships with institutions wishing to promote their archival collections. For example, reissues of recordings from the archives of INA-GRM have been released under the 'Recollection GRM' imprint of the Éditions Mego record label, and Bôlt Records, an independent record label based in Warsaw, has since 2010 released CDs from the archives of the Polish Experimental Radio Studio.

Many institutional electronic music studios established between the 1950s and 1970s either closed or went through periods of inactivity in the 1980s and 90s. This recent interest in electronic music histories has either coincided with or indeed has

⁵⁴ Georgina Born, *Rationalizing Culture: IRCAM, Boulez, and the Institutionalization of the Musical Avant-garde*. (Berkeley: University of California Press, 1995).

⁵⁵ 'Underground' is a contentious term that is necessarily difficult to define; I use it here in line with Stephen Graham's observations of music and music cultures that are primarily 'sounding' rather than written, like popular music, but in certain experimental aspects of form (such as duration) and in their appeal to small audiences are also congruous with art music, resulting in a kind 'nobrow' form, where 'tendencies from the "high" and the "low" forms percolate and resolve in distinct and sometimes strange ways'. See Stephen Graham, 'Notes from the Underground: a Cultural, Political, and Aesthetic Mapping of Underground Music' (unpublished PhD thesis, Goldsmiths, University of London, 2013), p. 22.

contributed to these studios being commemorated in various ways, either by reviving their activities, seeking to re-open them, or celebrating important anniversaries with the release of recordings and books, such as the Institute of Psychoacoustics and Electronic Music (IPEM) in Ghent, which produced a book and CD on the occasion of the studio's fiftieth anniversary in 2013; and events such as presentations and conferences. In 2017, a conference marking the sixtieth anniversary of the Polish Experimental Radio Studio took place in Łódź, Poland, at the Museum of Modern Art. This was followed by *Through The Soundproof Curtain*, an exhibition about the Polish Experimental Radio Studio at Zentrum für Kunst und Medien (ZKM) in Karlsruhe, Germany. In the UK, as well as being the subject of Louis Niebur's book *Special Sound* (2010), the BBC Radiophonic Workshop has been the subject of documentaries, drama productions, numerous magazine articles and public events such as an annual Delia Derbyshire Day, a celebration of one of its best known composers.

In some cases, projects that restore historical electronic music instruments have been part of these commemorations of historic studio environments. An example of this tendency, in which the restoration of an EMS Synthi 100 at Radio Belgrade was instigated within a wider project to celebrate the history of the Radio Belgrade Electronic Studio, will be described in Chapter Seven. My study of EMS takes place within, and contributes to, this landscape in which a renewed 'heritage' interest in electronic music and its technologies is being expressed by universities, museums and art galleries and in various areas of popular music culture.

While I have noted a recent increase in studies of historical electronic music and a concurrent interest in the topic in areas of popular culture and media, the historicisation of electronic music has been of concern to researchers for some decades. This has overlapped with concerns about the preservation and archiving of the working practices of electronic music studios. The term 'studio studies' as I use it here to describe histories of electronic music studios is an informal one that originated in correspondence with Simon Waters, who runs the Sonic Arts Research Centre at Queen's University, Belfast. Waters had previously been the director of the Electroacoustic Studio at the University of East Anglia (UEA), and I interviewed him while researching an MA thesis on electronic music at UEA in the 1970s and 80s. At the time of writing my thesis, the Electroacoustic Studio, and indeed the whole music department of UEA, had recently closed, so the challenges of preserving its history

inevitably came up in our correspondence. However, Waters had been concerned with the legacy of UEA's Electroacoustic Studio since the late 1990s, when he created an online archive for the studio. His reflections on this project shed some light on the challenges faced by researchers working with music that is not defined by a score, which is still the primary object of musical archives. Voicing concerns that are similar to those expressed by researchers working with the archiving of software and computer cultures, Waters proposes that the musical archive is,

... less able to deal with slippery notions of music as practice – of people doing things, of actions, of behaviours – which as a result are far more endangered than the objects we all start by archiving.⁵⁶

Likewise, in regard to preserving and archiving the activities of the Centro di Sonologia Computazionale (CSC) at Padua University, Laura Zattra et al wrote in 2001 that,

The most important and interesting thing to save is the intellectual environment, for it was specifically thanks to this that the whole activity [i.e. the music and research produced by the studio] actually took place.⁵⁷

Zattra et al, Hugh Davies, and other contributors to *Journal of New Music Research's* special issue on 'Conservation, Restoration and Archiving of Electroacoustic Music', raise concerns about the archiving of not only objects but also practices and processes that develop in a studio environment.

Therefore, this recent turn towards studying studios indicates not so much a change in the concerns of electronic music researchers so much as the growth of a receptive academic and non-academic audience for projects and publications that address these concerns, and the participation of institutions such as archives, museums and studios themselves in making materials and resources available to researchers. On a more fundamental level, electronic music's archive is changing. Digital technologies have helped to enable the preservation, archiving and re-presentation of a wider range

⁵⁶ Simon Waters, 'Making the Archive and Archiving the Making: Insights and Outcomes from a Major Research Project', *Organised Sound* 11: 2 (2006), 143–147 (p. 146).

⁵⁷ L. Zattra, G. Do Poli and A. Vidolin, A, 'Yesterday Sounds Tomorrow: Preservation at CSC', *Journal of New Music Research*, 30: 4 (2001), 407–412 (p. 406).

of cultural histories than before, both institutionally and in informal networks such as those that help produce the interest in archival electronic recordings described above. I propose that further research into the digital cultures of electronic music histories, both in official archives and in areas such as internet forums, blogs and social media, would produce useful observations about the nature of electronic music's archive: how it is constituted, how it has developed and is developing, who participates in it, and where academic studies of electronic music studios fit into this discussion.

1.5.1 Spaces of collaboration and conflict

A studio-based research model encourages us to think about the collaborative aspects of electronic music, which provokes important questions about musical authorship as well as disciplinary boundaries and the complex and interesting distribution of working roles within electronic music studios. This is an area that has been pursued by researchers including Laura Zattra, in her survey of the role of the assistant at INA-GRM, CCRMA and CSC;⁵⁸ and by Sean Williams in his continuing research on Stockhausen's compositions made in the studio at Westdeutscher Rundfunk (WDR). Williams has studied the under-documented role of the performance technician through reconstructing and using the music technology available at the time at the WDR studio and realising his own performance of Stockhausen's works. In doing so he shows how Stockhausen's music as we hear it emerges from a network of contingent relationships that take place in the studio and that challenge ideas of authorship, musicianship, performance and instrumentality. In regard to the realization (i.e. performance) made by Gottfried Michael Koenig – who was both a studio technician and a composer at WDR – of Stockhausen's *Studie II*, Williams writes,

If we think for a moment of the devices in the studio as constituting a kind of meta-instrument, or even consider each item as a discrete instrument, then we can understand that such a technician/performer/interpreter can be considered as much an instrumental musician as a violinist, an organist or a pianist.⁵⁹

⁵⁸ Laura Zattra, 'Collaborating on Composition: The Role of the Musical Assistant at IRCAM, CCRMA and CSC', in *Live Electronic Music. Composition, Performance and Study*, by F. Sallis, V. Bertolani, J. Burle and L. Zattra, eds. (Routledge ebook, 2017), pp. 59-80.

⁵⁹ Sean Williams, 'Interpretation and Performance Practice in realising Stockhausen's *Studie II*', *Journal of the Royal Musical Association* 141, 2 (2016), 445–481 (p. 478).

We can see from Williams's work how a focus on collaboration illuminates the contributions of those whose roles have not previously been considered important to the creation of music. The theme of collaborative relationships within an institution is also highly present in Born's *Rationalizing Culture*, in which she prioritises the voices of people who work at IRCAM in less prominent roles, rather than interviewing its founder, Pierre Boulez, and other senior staff. This decision gives voice to the members of an institution whose views are seldom heard – assistant tutors, *stagiaires* (graduate research students) and administrative staff – but also addresses a concern about the way in which large cultural institutions endeavour to control the way in which they are seen.

Born's documentation of IRCAM's software development is of particular interest as a rare example of an ethnographic, sociocultural approach to computer music research and what Born calls 'software culture'.⁶⁰ In Born's account of her research into two programs – CHANT, a vocal synthesis program, and FORMES, a program for manipulation of musical objects to create a syntax – she describes the relationships between the music, the music program, the high-level language in which it is written, and the hardware, noting the extreme mediation created by the abstraction, conceptualization and temporal delays inherent in developing a computer language. She also characterises the development process as frequently collaborative, bricolage-like and involving multiple authors. The idea of mediation is also central to the 'new organology' of musical and scientific instruments proposed by John Tresch and Emily Dolan, who describe a 'map of mediations' in which collaborations and relationships between not only people but also nonhuman actors, such as instruments, can be charted. As Tresch and Dolan note, while discussions of relationships between instruments have long been a part of organology texts,

Since the advent of electronic music in the 1920s, many issues surrounding instrumentation have transmuted into questions concerning the arrangement of studios and experimental music labs [...] How is a particular studio constituted? What is the relationship between people developing new technologies and those making music with

⁶⁰ Born, *Rationalizing Culture*, p. 14. Contemporaneous accounts of software, engineering and early internet cultures can be found in Susan Leigh Star's (ed.) *The Cultures of Computing* (New York: Wiley, 1995); however, Born's is the first such study to look at cultures of computer music specifically.

those technologies? How do scientific and musical practices merge and distinguish themselves? ⁶¹

As Born remarks in an interview in 2016, reflecting on her fieldwork at IRCAM, it is essential that the researcher, ‘move between two subject positions – between identification and distancing’.⁶² While Born is referring to her experience of researching the daily practices of an active organization, a similar approach is needed when researching the history of a studio, so as not to reproduce uncritically the narrative desired by surviving founders or participants. An example of this can be found in Sanne Krogh Groth’s *Politics and Aesthetics in Electronic Music. A study of EMS – Elektronmusikstudion Stockholm, 1964-79*. Stockholm’s Elektronmusikstudion (also known as EMS – I refer to it here as ‘EMS Stockholm’ to avoid confusion with the London-based EMS) has gone through many changes since its founding in 1964, but the organisation is still highly active. However, Groth’s study is deliberately concentrated on a 15-year period in the studio’s early history. This means that, rather than providing a generalising overview of EMS Stockholm from 1964 until the present day, Groth is able to focus on the conflicting aims and philosophies that emerged in the studio during its formative period in the 1960s and 1970s, as she explains how composers and other staff – as well as various actors outside of the institution – took opposing positions on how the studio’s resources should be used and what its future should be. Broadly speaking, there were those – including EMS Stockholm’s director, Knut Wiggen – who thought that the studio should be used primarily for computer music research and composition, and others who felt that the focus should be on maintaining the analogue tape studio in which sound poetry and musique concrète were the main activities.

Groth’s account of the studio sets up certain binaries along which conflict was likely to arise, between analogue and digital, praxis and theory, computer music and sound poetry, structuralist (as represented by the tape studio) and ‘autonomous’ (purely electronic) musical works, among others. However, she does not present these as fixed or insurmountable, finding areas of agreement by, for example, locating composers who worked across multiple areas, and noting how those on either side of

⁶¹ John Tresch and Emily Dolan, ‘Toward a New Organology: Instruments of Music and Science’, *Osiris*, 28 (2013), 278–298 (284 & 294).

⁶² I. C. Zubillaga and A. Fryberger, “My responsibility is to be bold” An interview with Georgina Born’, *Transposition: Musique et Sciences Sociales* (2016) <https://journals.openedition.org/transposition/1511>

the argument interpreted theoretical writings such as that of Pierre Schaeffer in different ways to suit their own positions. Groth notes that researching these aspects of electronic music through the perspective of an institution ‘has created an opportunity to analyse and challenge otherwise historically separated categories and traditions’.⁶³ Here, EMS Stockholm is not just a location but also a framework for analyzing anew some entrenched positions within electronic music historiography. The aim is not to ascertain whether or not EMS Stockholm followed a trajectory of success or failure during this period, but to situate the institution and its members within a wider landscape of electronic music, art and sociopolitical concerns and present a dialectical relationship between electronic music’s past and present.

1.5.2 Studio studies and musical works

Why is the studio an attractive starting point for thinking about historical works of electronic music? There are a number of reasons. Firstly, focusing on a particular studio leads to the consideration of a specific location and, often, a certain time period, thus providing a useful set of parameters for the researcher to consider how particular trends or schools within electronic music might have been shaped by the conditions of their production as well as the period within which they emerged. The location of the studio helps us to consider how electronic music created there contributed to contemporary music and arts practice in a certain city, country or region, as I discuss in Chapter Six, with reference to the Electronic Studio at Radio Belgrade in the context of modernist music and art in Yugoslavia. In the case of public institutions, we can also see how certain kinds of musical production might flourish over others through being supported and encouraged by government policies concerning culture and technology. For example, Born and Groth situate IRCAM and EMS Stockholm in the context of the cultural politics of France in the 1970s and Sweden in the 1950s to 1970s, Groth describing how, ‘with almost frightening precision ... representatives behind the construction of EMS positioned themselves within the Swedish social-democratic cultural-political landscape’.⁶⁴

Secondly, looking at studios as a space of creative and performative work can challenge the way in which electronic music is often defined unfavourably in relation

⁶³ Groth, p. 20.

⁶⁴ Groth, p. 76.

to various musical-philosophical concepts of the musical work and its performance. Very generally speaking, this centres on two things: electronic music's relationship with the score and musical notation as it is generally understood, and its capacity to be performed 'live'. For example, theorists of musical performance have tended to view the acousmatic performance of electronic music or the taped elements of a mixed electronic and acoustic composition as lacking the interpretational, expressive qualities of other kinds of performance because the recording process fixes the work in such a way that the audience hears a direct reproduction of what the composer has intended, with no interpretative elements contributed by the performer. Such performances are often categorised as 'playback' and thus are of limited interest in studies of musical performance. In *Musical Works And Performances: A Philosophical Exploration*, Stephen Davies acknowledges that 'purely electronic works are musical works', but maintains that 'they are ontologically distinct from pieces created for performance'.⁶⁵ His useful 'continuum of musical works and their performance' differentiates between the performative aspects of various kinds of recorded works and their reception; he also considers the ways in which technologies such as tape recorders and record players can be both musical instruments for performance *and* carriers of recorded music. Overall, though, there is in his writing a tendency to view the electronic musical work as primarily a reproduction of something that has already been performed in another context, and this crucial ontological difference designates electronic music as unavoidably secondary, if not inferior, to a 'live' performance (a notion that Sean Williams's research into the role of the performance technician implicitly critiques).

However, as more live performances are mediated by audio and visual technologies, the notion of 'liveness' itself has been interrogated by critics such as the performance theorist Philip Auslander, whose writing on liveness and 'mediatization' (and Paul Sanden's important development of Auslander's work) I draw on in Chapter Seven, when describing the presentation of a restored Synthi 100 on television.⁶⁶ Additionally, as musical performances as a whole continue to incorporate a wider range of relationships with scores and performance directions, the question of how to

⁶⁵ Stephen Davies, *Musical works and Performances: a Philosophical Exploration*. (Oxford: Oxford University Press, 2001) pp. 27, 7.

⁶⁶ Philip Auslander, *Liveness: Performance in a Mediatized Culture*, 2nd edn. (Abingdon/New York: Routledge, 2008); Paul Sanden, *Liveness in Modern Music: Musicians, Technology, and the Perception of Performance* (London: Routledge 2013).

think about ‘compositions for which the musical text is problematic, that is, non-existent, incomplete, insufficiently precise or transmitted in a nontraditional format’ become more urgent.⁶⁷ Michael Gallope, drawing on the writing of Jacques Derrida and Bernard Stiegler, issues a direct challenge to notions of the authentic musical performance as one in which a human performer interprets a written score:

Listening to recorded music does not involve understanding the complete origin of every specific edit, in other words, finding the traces of real performance behind the technical recording. It, conversely, involves merely hearing the end product as human, extending the definition of human music out through the prosthesis of recording, extending the definition of the music itself.⁶⁸

It is not within the scope of this study to interrogate in depth the conventions of musical aesthetics and analysis that have contributed to the relative lack of musical-philosophical literature on electronic music, although, like Demers, I think that there is much work to be done in developing a new aesthetics of ‘experimental electronic music’ that presents new models for interrogating such ideas as meaning, authorship, sound reproduction and the co-creative role of the listener in electronic music.⁶⁹ Nor do I propose that to focus on electronic music studios presents a complete solution to the problem of how to study the electronic musical work: if anything, the criticism could be made that emphasizing the importance of the studio tips the scales in favour of an overly contextual reading that evades the idea of musical meaning altogether rather than developing new ways in which to understand it. But it is possible to say that those aspects of the electronic musical work that have caused it to be regarded unfavourably or with suspicion – for example, Theodor Adorno’s notion that electronic music effects ‘the ubiquitous replacement of ends ... by means’ and demands ‘the predominance of the how over the what’ – become, in the context of studio-focused research, points of interest.⁷⁰ The studio provides concrete examples of the ways in which the creation of electronic music takes place under different

⁶⁷ Freidemann Sallis, ‘Introduction’, in *Live Electronic Music. Composition, Performance and Study*, by F. Sallis, V. Bertolani, J. Burle and L. Zattra, eds. (Routledge ebook, 2017).

⁶⁸ Michael Gallope, ‘Heidegger, Stiegler, and the Question of a Musical Technics’, conference paper, International Conference on Music and Consciousness (University of Sheffield, 17–19 July 2006) p. 10.

⁶⁹ Demers, *Listening Through the Noise*.

⁷⁰ Theodor Adorno, ‘Music and New Music’, in *Quasi una Fantasia: Essays on Modern Music*, trans. by R. Livingstone (London and New York: Verso, 2012), p. 266.

conditions than other forms of music, and demands, therefore, a different approach or approaches not only to the composition but also to reception and analysis of music. Looking at the studio, we see examples of how, in electronic music, the composer and performer are often the same person; how the performer might be a nonhuman actor such as a computer; and how the author of the work is frequently best understood as a group of people and technologies rather than just one composer. Rather than seeing these as traits that bestow or detract from musicality or the quality of a musical work, they could be reframed as conditions, necessities, possibilities – definitive and constitutional, neither advantageous nor disadvantageous, and with important aesthetic, social and political implications.

Through the studio we can construct new frameworks in which to study a body of music that has so far lacked cohesive theoretical models or wide-ranging considerations of its aesthetics. Rather than producing a canon of notable contributions attributed to single authors, one-off experiments, collaborative works, ‘failures’, functional music and supposedly minor pieces can be contextualised and reappraised. Through constructing these studio-focused, operational histories, and thus adding to the empirical and historical body of knowledge about electronic music, it is possible that new aesthetic approaches can be furthered and strengthened.

1.6 Studios within studios: synthesizer historiography, organology and EMS

While the VCS3 and other EMS devices have for some decades been celebrated in audio-technical publications such as *Sound On Sound*⁷¹ and in sourcebooks such as Peter Forrest’s directory *The A-Z of Analogue Synthesizers*, EMS makes only a minor appearance in the small body of academic synthesizer and music technology historiography produced by Paul Théberge, Trevor Pinch and others. Théberge’s important account of the growth of the synthesizer market, *Any Sound You Can Imagine: Making Music/Consuming Technology*, which is focused almost solely on North American and Japanese companies, does not mention EMS even in passing. This is an indication not only of EMS’s failure to make a significant impact on the US synthesizer market – although its VCS3 and Synthi A models, re-branded as the ‘Putney’ and the ‘Portabella’, respectively, were sold in small numbers in North

⁷¹ Graham Reid, ‘All About EMS, Part 2’, *Sound On Sound*, December 2000.

America and Canada – but also reminds us of what has changed since Théberge’s book was published in 1997, in other words, before online, and therefore global, communities and marketplaces devoted to ‘vintage’ music technology became commonplace.

An account of EMS in the area of synthesizer historiography is found in Pinch and Trocco’s *Analog Days: The Invention and Impact of the Moog Synthesizer*, in a chapter titled ‘From Daleks to *The Dark Side of the Moon*’. As the chapter’s title suggests, the use of EMS synthesizers in popular music and television sound design are emphasised here.⁷² As well as noting the VCS3’s connections to popular culture, Pinch and Trocco’s aim is to place EMS within a history of invention and manufacture along the lines of Moog, Buchla, and ARP, the company set up by Alan Robert Pearlman which was Moog’s closest competitor in the US. Although Pinch and Trocco’s account clearly demonstrates their admiration for EMS’s synthesizers, particularly the VCS3, their summary of why EMS failed to thrive and expand past the late 1970s places it as something of a footnote in the history of synthesizer manufacturing, compared to the more successful US companies. (In fact, as Théberge notes, Moog – which had been sold to another company, Norlin, in 1977 – went into liquidation in 1985, ARP already having done so in 1981; EMS’s trajectory was therefore not unusual.)⁷³

Another technology-focused account of EMS can be found in Manning’s *Electronic and Computer Music*, which categorises EMS’s different operations not as opposing commercial and uncommercial ventures, but along the lines of the development of practices and technologies in electronic music. Thus EMS’s computer activities are surveyed in a section on hybrid synthesis, the technique of computer controlled analogue synthesis of which Peter Zinovieff and David Cockerell were among the earliest and most advanced proponents, while EMS’s synthesizers are featured in a chapter focusing on the development of voltage-controlled instruments.⁷⁴

This relative lack of EMS scholarship in the area of synthesizer historiography is being redressed, most notably through the research of James Gardner, whose Radio New Zealand series on electronic music histories, *These Hopeful Machines*, included valuable interviews with key EMS personnel. As seen earlier in this chapter, Gardner

⁷² Pinch and Trocco, *Analog Days*, Ch. 14.

⁷³ Théberge, *Any Sound You Can Imagine*, p. 58.

⁷⁴ Manning, *Electronic and Computer Music*, Chapters 6 and 11.

has also published several papers on EMS, the most important of which to date is his account of the VCS3, ‘The Don Banks Music Box to The Putney’;⁷⁵ Gardner’s full-length study of EMS is currently in progress.

In including chapters on EMS in early computer and digital music and its relationship to computer and media arts via the Computer Arts Society, I add to Pinch and Trocco’s history, which deprioritises EMS’s research activities and digital inventions in favour of an examination of the company’s commercially available synthesizers, and provide a more contextual take on Manning’s account, which does not consider the wider cultural framework in which EMS operated, nor the ways in which EMS the studio and EMS the company were closely connected. My approach to synthesizer historiography draws from new studies in organology, in particular Tresch and Dolan’s aforementioned notion of a ‘map of mediations’ in which an instrument or a technology is situated, which can include its location, its users, the compositions written for it, its sound, and so on. Following the writing of Michel Foucault, Tresch and Dolan develop the idea of an ethics of the instrument, in other words looking at the relationships between the instrument and its user, its material disposition, the aims towards which it is used, and how it situated in social and cultural life. Crucial to Tresch and Dolan’s proposal is the idea that uses of instruments and technologies, and the relationships between and around them, can and do change; and tracing the different ends to which they are put (the ‘telos’) can provide useful insights into ‘technical and cultural histories of music and science over several centuries’.⁷⁶

1.7 Conclusion

EMS lends itself to a kind of dispersed studio studies, one that looks not at the heritage status of one institution but considers a more discontinuous set of locations, devices and practices. In the following chapter, and throughout this study, I combine a focus on individual technologies with an examination of some of the places and organisations that surrounded, preceded, influenced and were influenced by EMS, noting a number of concert halls, art galleries, colleges, technology companies and

⁷⁵ James Gardner, ‘The Don Banks Music Box to The Putney: The Genesis and Development of the VCS3 Synthesiser’, *Organised Sound* 22: 2 (2017), 217–227. See also *These Hopeful Machines* series (Radio New Zealand, 2013)

<https://www.rnz.co.nz/concert/programmes/hopefulmachines>

⁷⁶ Tresch and Dolan, ‘Toward a New Organology’, p. 75.

other electronic music studios that form a constellation of sympathetic spaces, including the speculative national studio which was never realised. This helps us to think about EMS away from the deterministic narrative of success and failure that might frame the account of a short-lived creative and commercial enterprise, and focus more on its important, diffuse and unique presence in the landscape of postwar electronic music.

Figure 1.1 EMS, c.1974. Promotional photograph showing the Synthi 100 (right) and PDP8 computers (centre). Source: unknown [REDACTED]

EVERY PICNIC NEEDS A **SYNTHI**

Electronic Music Studios (London) Limited
49 Diodor Road London SW15 Telephone 01-874 2363
New York 140 East 80th Street NY, 10021 U.S.A.

The Synthi Range by **EMS**



EVERY BAND NEEDS A **SYNTHI**



The Synthi Range by **EMS**

Electronic Music Studios (London) Limited
49 Deodar Road London SW 15 Telephone 01 874 2363
New York 408 East 78th Street N.Y. 10021 USA

Some already have one
Pink Floyd The Who Yes Family King Crimson Curved Air Led Zeppelin Jethro Tull Roxy Music Hawkwind
Moody Blues Fleetwood Mac Three Dog Night Sly and the Family Stone Tonto's Expanding Headband
..... to name a few

Cybernetic Serendipity Music

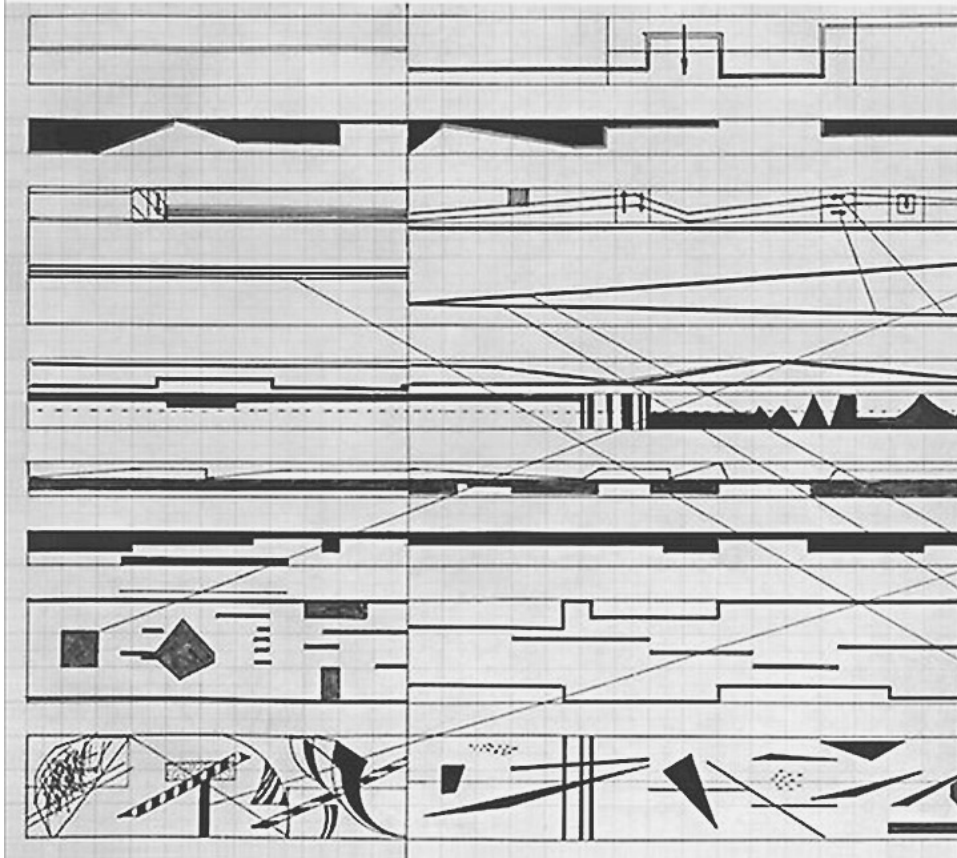

Chapter 2

Electronic music in public: kinetic art, computer music, shared technologies and divergent aims

2.1 Introduction

This chapter examines how the conditions of possibility for the founding of EMS were established through various networks in art and technology as well as in music.

Focusing on music and art events and the establishment of groups and organisations, I examine electronic music's public presence in the UK in the late 1960s.

In the years leading up to its establishment as a company and professional studio, the nascent EMS was situated not only within the context of contemporary concert music as defined by organisations such as the Society for the Promotion of New Music (SPNM), but also in relation to visual arts, media and computing. I introduce some of the galleries, colleges, concert venues, new music organisations and computing companies that were in the orbit of Peter Zinovieff and his colleagues Tristram Cary and Alan Sutcliffe between 1966 and 1969, illustrating how their different backgrounds, preoccupations and interests contributed to the formation of EMS.

Taking as a starting point a concert given in 1966 at the Watermill theatre in Berkshire, I discuss the activities of Unit Delta Plus, a production company/electronic music group set up by Peter Zinovieff with Delia Derbyshire and Brian Hodgson of the BBC Radiophonic Workshop. Examining Zinovieff and Derbyshire's collaboration on a piece for this concert as a jointly authored work, I also propose that the short-lived Unit Delta Plus, through its links with kinetic artists and two of its members' involvement with audiovisual media, represented an early and unrealised attempt to create a cross-disciplinary context for electronic music.

Next, I examine *ZASP*, a piece of computer music composed by Peter Zinovieff and programmer Alan Sutcliffe in 1968 and entered into the International Federation for Information Processing (IFIP)'s competition for computer music that year, where it won second prize. This led to Sutcliffe's founding of the Computer Arts Society. Giving an account of the Computer Arts Society's launch event, Event One, which took place at the Royal College of Art in March 1969, I speculate as to why, following

this event in which EMS played a part, the connections between computer music and computer art, at least as far as EMS was concerned, did not develop further.

In Chapter One, I mentioned an event titled A Concert of Electronic Music, which took place in the Queen Elizabeth Hall, London, in January 1968. Describing this concert and the Redcliffe Concerts of British Music series of which it was a part in more detail in this chapter, I consider the composer Tristram Cary's involvement in and advocacy for electronic music in the UK, assessing the extent to which Cary's relationship with the various bodies concerned with contemporary concert music in the UK at this time, such as the Society for the Promotion of New Music, the Composers' Guild and others, contributed to the public profile of electronic music in London's contemporary music community of the late 1960s. I propose that Cary, through his writing about electronic music in musical and other publications, and his setting up of an electronic music studio at the Royal College of Music, helped to steer EMS more decisively towards a musical milieu, rather than the other disciplinary pathways suggested by Unit Delta Plus and the emerging computer arts movement.

In his study of the 1960s architecture collective Archigram, Simon Sadler presents his project as 'an excursion into the Archigram moment'.¹ Similarly, this chapter can be read as an exploration of the 'moment' of EMS, in exploring a period of two to three years in which cultural and technological conditions existed that produced events such as the ones outlined in this chapter and also offered various routes that electronic music and arts might take in the following years. As Sadler also notes, the 'circumstantial' connections (in culture, technology and politics) that could be made to Archigram are – as they might also be with EMS – 'practically infinite'. This chapter, therefore, represents a partial selection of contemporaneous narratives, figures and locations, none of which offers, in itself, a definitive answer for why EMS emerged when and how it did, but can show us a possible outline of the organisation's character as it came into being.

¹ Simon Sadler, *Archigram: Architecture Without Architecture* (Cambridge, Mass/London: MIT Press, 2005), p. ix–x.

2.2 Sound, light and sculpture: Unit Delta Plus at the Watermill Theatre

The first concert of electronic music in England did not take place in a London concert hall, but in a tiny village sixty miles from the capital, in a building dating from the early nineteenth century. The Watermill Theatre in Bagnor, near Newbury, was still a work in progress when the members of Unit Delta Plus hired it for the concert, which took place on 10 September, 1966. David Gollins, a student at the Royal College of Music whose mother owned the old mill building, had begun converting it in the early 1960s and by 1965 had constructed a stage and galleries in the style of an Elizabethan courtyard theatre, seating an audience of just over a hundred.²

The sparsely furnished space with white-painted walls and second-hand chairs functioned as a gallery as well as a concert venue for the Unit Delta Plus event. Paintings by Peter Zinovieff's daughter, Sofka, were hung on the walls, an electromagnetic sculpture by the kinetic artist Takis was borrowed from the Signals gallery in central London, and projections by the Light/Sound Workshop from Hornsey College of Art were commissioned to accompany three of the pieces on the programme: Delia Derbyshire's *Amor Dei* and *Moogies Bloogies*, and *Random Together 1*, composed by Derbyshire and Zinovieff. The programme featured two more compositions by Zinovieff, *Tarantella* and *Agnus Dei*, Derbyshire's *Pot-Pourri* and *Fragments* by Brian Hodgson. The concert reflected the fact that, in the UK in 1966, one would have been most likely to hear electronic music via the radio or television, as Hodgson's *Fragments* and Derbyshire's *Amor Dei* (a music and text collaboration with playwright Barry Bermange) were both initially made for radio broadcast. *Pot-Pourri* was an edited compilation of introductory themes that Derbyshire had composed for the BBC Radiophonic Workshop in around 1965.³

The visual elements of the concert attested to the connections across art forms and creative communities that electronic music had the potential to form. Such connections could be fragile and temporary. David Medalla and Paul Keeler's Signals gallery had launched in 1964 with a focus on kinetic art, putting on exhibitions by Medalla, Lygia Clark, Hélio Oiticica, Takis and others and publishing its own newspaper, the *Signals Newsletter*; by 1966 it became clear the gallery was

² Jill Fraser, *My Watermill Story* (Aldeburgh: Sargant, 2009), p. 19.

³ James Percival, 'Delia Derbyshire's Creative Process' (unpublished MA thesis, University of Manchester, 2013), p. 23.

financially unsustainable and by the end of the year it had closed.⁴ The Light/Sound workshop did not survive after the departure from Hornsey College of Art of its director, Clive Latimer, in 1968.⁵ As a group, Unit Delta Plus itself was also short-lived, with the trio who formed it no longer working together by the end of 1967. But these ventures inspired new ones: Derbyshire and Hodgson soon established a new studio and production company called Kaleidophon, with composer David Vorhaus, based in Camden Town, north London, while Signals inspired the first exhibition at the Indica Gallery in 1966, *Indications One*, a group show of many of the kinetic artists featured in the former gallery.⁶ Unit Delta Plus, operating from Zinovieff's home at 49 Deodar Road and using equipment that he had commissioned or built, was an important precursor to EMS.

Unit Delta Plus was one of a small number of private studios operating in London in the 1960s, according to the composer Hugh Davies's *Répertoire International Des Musiques Electroacoustiques/International Electronic Music Catalog*, published in English and French in 1968.⁷ As I explain in Chapter One, this directory of electronic music studios, composers and compositions gave a valuable overview of international electronic music practice up to 1967 and, in doing so, 'presented electronic music – for the first time – as an apparently coherent, international, interdisciplinary praxis'.⁸ In the *Catalog*, according to a key that divides studios into combinations of 'permanent', 'improvised', 'private' and 'official', Unit Delta Plus is listed as a 'PP', a 'permanent private' studio, a classification also assigned to Ernest Berk's studio in Camden, and Ron Geesin's in West Kensington. As with Unit Delta Plus, both of these studios provided music for TV and film, with their founders concurrently working on their own practice – experimental and improvised music in Geesin's case, while Berk composed music for ballet productions. The prototypes of such studios

⁴ Guy Brett, *Exploding Galaxies: The Art of David Medalla* (London: Kala Press, 1995); Jill Drower, *99 Balls Pond Road: The Story of the Exploding Galaxy* (London: Scrudge, 2014), p. 10.

⁵ David Curtis, *A History of Artists' Film and Video in Britain* (London: BFI/Palgrave MacMillan, 2007) p. 24.

⁶ Carmen Juliã 'You Saw It Here First: Gallery One, New Vision Centre, Signals and Indica at Tate Britain', *Tate, Etc.* 24 (Spring 2012).

⁷ Hugh Davies, *Répertoire International des Musiques Electroacoustiques / International Electronic Music Catalog*. (Paris & Trumansburg, NY: Groupe de Recherches Musicales de l'ORTF & Independent Electronic Music Center, Inc., 1968).

⁸ James Mooney, 'Hugh Davies's Electronic Music Documentation 1961–8'. *Proceedings of the Electroacoustic Music Studies Network Conference: Electroacoustic Music Beyond Concert Performance*, (Berlin, June 2014) p. 8. (www.ems-network.org/IMG/pdf_EMS14_mooney.pdf)

were those belonging to Daphne Oram and Tristram Cary, based in Kent and Suffolk respectively.

Davies's cataloguing system also sought to define the purpose of each piece of music composed in these studios, whether for film, concert, radio, and so on. It is perhaps significant that the majority of the Unit Delta Plus works in the *Catalog* are categorised as 'concert', even though, as we know, some of these were radiophonic works, or new versions of radio signature tunes, remixed, as we would call it now, for concert presentation. This serves as a reminder of the newness of electronic music in the UK at this time, as well as its close connections with broadcast media, which provided one of the few opportunities to work with electronic sound. The reconfiguring of functional music into concert music highlights the importance of the Watermill concert for establishing an idea of what electronic music 'was'. At this small event in a provincial theatre, recomposed radio jingles and complex experiments in sound generation, such as the work described below, were both presented as representative of a new way of making music.

2.2.1 *Random Together 1*

Random Together 1, a collaborative piece by Zinovieff and Derbyshire, represents, as James Percival writes, a 'tantalising historical "what-if"' regarding Delia Derbyshire's trajectory as a composer. He speculates that, under different circumstances,

in the latter years of her musical career, she might have applied her approach to analysing and resynthesising complex timbres to the computer-controlled analogue synthesis technology being developed by Zinovieff and EMS.⁹

A series of notes that were compiled for the concert by Zinovieff and Derbyshire give an account of a process highly dependent on probabilistic methods, deliberately circumscribing the role of the composers in both the choice of sounds used and parameters such as reverberation, attack and decay, as well as the distribution of the sounds over different tracks (so that the resulting mix also has random elements).

In an introduction to the concert's programme notes, Zinovieff writes,

⁹ Percival, p. 34.

The studio of Unit Delta Plus has specialised in electronic switching arrangements to reduce the manipulation, editing and copying of tape, and also in the development of controlled randomness in certain aspects of sound.¹⁰

He goes on to explain the methods by which this controlled randomness is made possible, describing an early version of a sequencer that can randomly select from 32 tones, time intervals and levels of loudness, with the possibility of loading it in favour of particular choices. This device was made by Zinovieff and Mark Dowson, the engineer who worked with Zinovieff until 1966, when he was replaced by David Cockerell.¹¹

Random Together 1 uses a combination of rapid sine tones and un-pitched, more 'noisy' textures. Both sound as if they were generated using the probabilistic methods described above and then treated in a way that is consistent with Derbyshire's compositions, with ring modulation, reverb and filters.¹² The piece is in three movements, and the programme notes state that only the second of these is 'musically self-sufficient' and should be played in darkness; the first and third have been conceived to correspond with light projections.¹³

Whereas, elsewhere in the concert, the light show accompanied already existing compositions, here composers and visual artists collaborated on a joint audiovisual work. A conceptual common ground can be seen between the composers and artists in their shared interest in how audiences perceived and felt the effects of electronic sound and image, and in a preoccupation with randomness and aleatoric methods of structuring sequences of light and music. In a letter following a meeting with Zinovieff and Derbyshire, Michael Leonard of the Hornsey Light/Sound Workshop describes the Workshop's simple 'mechanised technique' that controls the movement of the projectors and enables fading between them. Even though true synchronisation between sound and image is not possible, he writes, 'the idea is to create a random

¹⁰ DDA/1/1/6/13/2. References beginning 'DDA' refer to paper items in the Delia Derbyshire archive; those beginning 'CDD' refer to audio items.

¹¹ Gardner, 'Even Orpheus needs a Synthi', *Tempo 70* (2016), p. 60; Trevor Pinch and Frank Trocco, *Analog Days: The Invention and Impact of the Moog Synthesizer* (Cambridge, MA: Harvard University Press, 2002) p. 169; Peter Zinovieff, 'EMS Milestones', *PAGE 69* (Spring 2013), p. 5. In notes regarding the composition, Derbyshire refers several times to 'Mark's device' (DDA/1/1/6/6).

¹² A possibly incomplete recording of the piece is archived as CDD/1/6/3 in the Delia Derbyshire Archive.

¹³ DDA/1/1/6/13/2.

structure by overlay of sound and image which will be meaningful'.¹⁴ In a later letter to Derbyshire, Leonard elaborates on how sound and image could be made to work together, offering ideas about the spatialisation and structuring of sounds as well as suggestions regarding dynamics and transitions within the piece. The impression given is of a potentially valuable collaboration in which both parties worked towards a shared idea of multisensory performance that was realised in *Random Together 1*.

2.2.2 Unit Delta Plus and kinetic art

A few months after the Watermill concert, Michael Leonard approached Unit Delta Plus to discuss collaborating again on a commission for the Brighton Festival, the first edition of which was to take place in April 1967. This new project was a major one for the Advanced Studies Group of Hornsey College of Art, of which the Light/Sound Workshop was part, involving students from Fine Art, Visual Research, Film and TV, and Three-Dimensional Design working on a number of 'audio/visual/kinetic environments' collectively named *K.4* and presented on Brighton's West Pier. Derbyshire and Hodgson supplied sound and music for the festival, including an extended version of Delia's composition *The Delian Mode* re-titled *Labyrinth*.¹⁵ The project once again demonstrated the shared ground between electronic music and kinetic art.

The formation of Unit Delta Plus coincided with the growth of kinetic art in the 1960s, following exhibitions such as Jean Tinguely's touring show that began as *Bewogen Beweging* (Moving Movement) at the Stedelijk Museum, Amsterdam, in 1961, and the strong presence of kinetic art at both the Venice Biennale and Documenta in 1964.¹⁶ It is easy to see the appeal of these new, increasingly interactive artworks for technologically informed composers and sound designers such as the members of Unit Delta Plus. Electronic music and kinetic art both drew attention to the relationship between art, science and technology, and were in a sense predictive of the essential role that electronic and digital technology would play in visual and sonic arts in the future.

¹⁴ Michael Leonard to Unit Delta Plus. DDA/1/1/6/4/1.

¹⁵ Percival, p. 113; CDD/1/6/6.

¹⁶ Kristine Stiles and Peter Selz, *Theories and Documents of Contemporary Art*. 2nd edn. (Oakland: University of California Press, 2012), p. 450.

Connections already existed between kinetic art and music: compositional methods such as those used by Earle Brown influenced the work of Takis, who began to incorporate music and sound into his sculptures in the mid-1960s and collaborated with Brown on the 1963 work *Sound of Void*. However, I propose that the work of Unit Delta Plus can be seen in dialogue with aspects of kinetic art primarily in a shared concern with time-based technologies. None of the members of the group had studied art, yet their connections with broadcast media and music-technological research made them conversant with audiovisual practice, the principles of acoustics and sound engineering, and considerations of space and audience perception. Neither Derbyshire, Hodgson nor Zinovieff were trained composers in the traditional sense; instead, although Derbyshire had studied music at university and used musical notation as well as technical instructions in some of her plans and scores, they all tended to work directly with sound, often giving details of timbre and texture priority over musical material. Randomly generated, synthesized, recorded, spliced and dubbed, the music of Unit Delta Plus gave the impression of being sculpted and set in motion, much like the electromagnetic artwork transported to the Watermill for the concert.

In working with bodies such as Hornsey College of Art and Signals Gallery, the members of Unit Delta Plus were, of course, making use of their contacts – such as the critic Guy Brett, one of the editors of *Signals Newsbulletin* and an associate of Zinovieff's¹⁷ – and taking advantage of their coincidental proximity to London's dynamic art scene. However, what we know about the Watermill concert, particularly from notes and materials kept by Delia Derbyshire, suggests that the trio incorporated audiovisual elements not just for the sake of entertainment but also out of a deeper interest in how electronic music should be perceived – seen and felt, as well as heard.

Unit Delta Plus gave occasional lectures about their work in academic institutions, giving a presentation at Goldsmiths, University of London, at which Derbyshire and Hodgson first met their Kaleidophon collaborator, David Vorhaus; and another at the Royal College of Music in 1967. Organised by Tristram Cary, who was then in the process of setting up an electronic music studio at the RCM, it was this event that led to the closure of Unit Delta Plus, according to Brian Hodgson. In Hodgson's account, Zinovieff had decided that the lecture would instead be a 'happening', but didn't tell

¹⁷ Zinovieff also provided the music for the film, *Takis Unlimited*, dir. Mahmoud Khosrowshahi (1968).

his colleagues, resulting in a ‘chaotic’ evening. The next day Hodgson and Derbyshire broke up the group in writing, delivering a letter to the studio in Putney. By this point, Hodgson concedes, they were ‘pulling in all directions’, and appeared to be reaching a natural conclusion.¹⁸ The event at RCM did not sever ties between the three members of the group, but it reconfigured their relationship. Once it was established as a manufacturer, EMS London Ltd supplied synthesizers to the BBC Radiophonic Workshop, with Hodgson advocating for their use and facilitating the communication between Peter Zinovieff and the Radiophonic Workshop director Desmond Briscoe: I expand on this relationship in Chapter Five.

It was clear from Zinovieff’s limited participation in Unit Delta Plus that, while he provided a base and facilities for Hodgson and Derbyshire, and collaborated on some of their commissions, he was less interested in the commercial jobs the group took on alongside their more prestigious assignments for theatre (including a commission for the Royal Shakespeare Company’s production of *Macbeth* in Stratford-upon-Avon, 1967).¹⁹ This included generic music and sound for advertisers such as Proctor & Gamble, as well as a foray into pop music when a tape of Unit Delta Plus’s music was played in 1967 at the Million-Volt Light And Sound Rave, a large-scale event that took place over two evenings in January and February at the Roundhouse in Chalk Farm, North London, an important location for rock concerts and other countercultural events from the mid-1960s onwards. Organised by the artist-designers Douglas Binder, Dudley Edwards and David Vaughan, the concerts featured a tape piece composed by Paul McCartney of The Beatles as well as a performance by the Jimi Hendrix Experience, light shows and films.²⁰

The concert of electronic music at the Watermill in 1966 was a rare occasion upon which Unit Delta Plus’s varied interests – commercial and functional music, pop, radiophonics, aleatoric composition and audiovisual performance – ran successfully in parallel and even, in the case of *Random Together 1*, merged into a genuinely collaborative effort. While the promise of this multifaceted event was only partially fulfilled, it remains an important early statement of how electronic music could be,

¹⁸ Brian Hodgson, interview with author, 2016.

¹⁹ DDA/08/4055.

²⁰ See Mark Brend, *The Sound of Tomorrow: How Electronic Music was Smuggled into the Mainstream*. (London: Continuum, 2012), pp. 177–8; MacDonald, *Revolution in the Head: The Beatles’ Records and the Sixties*. 4th edn. (Chicago: Chicago Review Press, 2007), pp. 225–6.

and could have continued to be, presented – as immersive, experiential artworks that incorporated other media such as sculptures and light.

2.3 Alan Sutcliffe, ZASP and the Computer Arts Society

In 1962, Alan Sutcliffe, an engineer and industrial designer, attended the Summer School of Music at Dartington Hall, Devon. First set up in 1947 in Bryanston, Dorset, by the critic William Glock, the Summer School moved to Dartington in 1953, and since then has offered an annual course in contemporary music for amateur and professional musicians. The School's openness to all levels of musical experience – 'for every kind of music-lover', as its 1964 brochure advertised²¹ – was in keeping with the ethos of inclusivity, creativity and social justice fostered by the Dartington Trust, which was established in 1925 by philanthropists Dorothy and Leonard Elmhirst as an experiment in rural regeneration. While much of the content of the Summer School consisted of pre-twentieth century classical music, developments in new music were also reflected in the curriculum and concert programmes. The year in which Sutcliffe attended included a workshop in electronic music taught by Luciano Berio, assisted by Delia Derbyshire; the BBC Radiophonic Workshop supplied the equipment for Berio's course.²²

In Sutcliffe's account, his meeting with Derbyshire at Dartington led to a short romantic relationship which was curtailed by their living in different parts of the country.²³ Sutcliffe contacted Derbyshire when he moved from Yorkshire to greater London in 1966 to start work at International Computers and Tabulators, which in 1968 became International Computers Limited (ICL). Derbyshire introduced Sutcliffe to Peter Zinovieff, with whom she guessed he would share an interest in both music and computing. They were also neighbours of sorts: ICL's new headquarters, designed by Centropoint's architect Richard Seifert, were based at Putney Bridge, just across the Thames from where Zinovieff was in the process of establishing his studio. According to Sutcliffe, Zinovieff sought his help in programming the new PDP-8S

²¹ Dartington Trust, 1964.

²² DDA/1/6/1646.

²³ Alan Sutcliffe, 'Patterns in context', in *White Heat Cold Logic British Computer Art 1960–1980*, ed. by P. Brown, C. Gere, N. Lambert, and C. Mason (Cambridge, Mass: MIT Press, 2008), p. 175.

computer he purchased in 1967.²⁴ The two men decided to combine their experience and work together on a composition. Zinovieff recalls,

We had this idea that he would be able to get the great big ICL1900 computer to generate numbers, which I could then feed in with a paper tape reader and then play on oscillators. So that's exactly what we did. He came across the bridge, which had a footpath next to it, from his building to where I worked, with a canister of punch tape, and I wrote a program which would interface the numbers of those from the punch tape to the frequencies of the oscillator, and so we produced this piece called *ZASP*.²⁵

Once Sutcliffe had gained permission from ICL to use the ICT 1095 computer for this extracurricular activity, he began work on a program that was called, like the resulting composition, *ZASP*, a rearrangement of his and Zinovieff's initials. Written in FORTRAN, Sutcliffe's program specified the length of the piece's movements and various parameters such as pitch, duration, loudness and waveform. The program, printed onto a paper tape, was then read by Zinovieff's PDP-8/S, which controlled the sound producing equipment and determined how each part of the piece should be electronically treated with filtering, reverberation, echo and so on. In simple terms, we might say that Zinovieff's equipment 'realised' the composition, which was 'composed' by Sutcliffe's program; but as I note below, such terms were not always sufficient to describe working processes and relationships in electronic music.

ZASP was completed in 1968 and submitted to the International Federation of Information Processing (IFIP)'s competition for computer music, where it won second prize; it was licensed to the BBC in 1969.²⁶ As the composers claimed, it was the first piece of music to be composed on one computer and realised on another. This fact alone sounded impressive, for, if using one computer to make music at this time was a rare occurrence, the idea of using two seemed remarkable, even if many people would have no idea what this meant or entailed in real terms.

Zinovieff and Sutcliffe remained friends and colleagues throughout the lifespan of EMS, with Sutcliffe joining the company in the second half of the 1970s to work as a programmer, and holding a position as a director. He took an active interest in EMS's

²⁴ Ibid.

²⁵ Peter Zinovieff, interview with author, 2016.

²⁶ A version of the piece can be heard on the CD by Peter Zinovieff, *Electronic Calendar: The EMS Tapes* (Space Age Recordings, 2015).

financial affairs, drawing up budgets and preparing bids for possible investors. Documents detailing his role in meetings about the company's liquidation show that he remained with EMS until its closure.²⁷ In 1968 Sutcliffe co-founded the Computer Arts Society, and remained committed to computer arts until in his death in 2013. Sutcliffe's role in the history of EMS helps us to situate the beginnings of the studio in the context of experiments with computing in visual arts and design in London during the 1960s.

2.3.1 Machines Like Men: computing and composing in the 1960s

It can be seen from Alan Sutcliffe's writing that he was aware of the work of Stanley Gill, a professor of computing at Imperial College, London.²⁸ In 1962, a piece of music composed by Gill using a computer was played on a BBC TV programme called *Machines Like Men*.²⁹

Gill's piece had been composed using a program written for the Pegasus computer, made by the British company Ferranti Ltd; but it is important to note that this was not a piece of electronic music, in the sense that it did not use electronic sound sources. Instead, in the manner of compositions made in the late 1950s by Lejaren Hiller and Leonard Isaacson, the program produced a 'score' for 'three voices', which was translated into musical notation to be played by violin, viola and bassoon.³⁰ Gill's program used serial composition as its model, with the aim of sounding similar to compositions by Schoenberg and other Viennese School composers. Not only did this bestow a musical style that was easily understandable as 'modern', it seemed a natural translation from one kind of calculational process – as serialism was frequently thought to be – to another.

In his article, Gill remarked that the modern musical environment was already a 'turbulent' one in which composers were expressing themselves using tapes, tone generators and so on – and composing with a computer introduced 'yet another new

²⁷ MS/2160, Financial Material & Price Lists. (Numbers beginning MS refer to the Alan Sutcliffe Archive, Science Museum, London.)

²⁸ Alan Sutcliffe, 1968; 'Programming to Make Music', *Computer Weekly*, 8 (August 1968); Sutcliffe, 'Patterns in Context'.

²⁹ *Machines Like Men* (1962). Gordon Rattray Taylor (Writer). BBC 2, 20 August, 1962.

³⁰ Stanley Gill, 'A Technique for the Composition of Music in a Computer' (1963), in *Machine Models of Music*, ed. by S.M. Schwanauer and D. A. Levitt (Cambridge, Mass: MIT Press, 1993), p. 43.

complication'.³¹ His misgivings about the composer's relationship with the computer echoed the tone of *Machine Like Men*'s script, written by the science author Gordon Rattray Taylor, which proclaimed:

We must learn to live with them... Fantastic devices that ape human behaviour... Machines that forge signatures, talk, sing, and even recognise and obey the human voice... Now, a brain that works a hundred million times faster than its creator's – and learns from its own mistakes.³²

Yet Gill was also able to foresee a future in which a composer and a computer worked together as a 'co-operative venture', which would be made possible by the invention more powerful computers and the design of specific music software – a prediction that turned out to be accurate.³³

In 1968, Gill, by then the president of the British Computing Society, was one of the judges of a competition for computer music in that year's IFIP Congress, which took place in Edinburgh on 8 August. Although *ZASP* took second place in the competition behind Iannis Xenakis's string quartet *ST-4*, Sutcliffe and Zinovieff's composition stood out by virtue of its being composed not for traditional instrumentation but for electronic sound. Rather than producing a score to be played by acoustic instruments, which the other entrants had done, the composers had written a program that could be interpreted by another computer and the various electronic sound sources to which it was connected, demonstrating a new kind of mediation between composer, score, performer and sound. As Sutcliffe wrote with hindsight in 2008, he and Zinovieff had decided against 'simulating conventional composing procedures', instead, 'developing ones natural to computer composition of electronic music.'³⁴ Here it is possible to see the emergence of an aesthetic idea of computer music that goes beyond the merely procedural. In notes compiled for the IFIP presentation, the composers of *ZASP* elaborated upon what this music might be like:

³¹ Ibid., p. 51.

³² *Machines Like Men*.

³³ Gill, p. 51.

³⁴ Sutcliffe, 'Patterns in Context', p. 178.

It is a music of patterns and textures, more like the patterns and textures of nature, perhaps, than most music. In it there is a balance of control and randomness, uniformity and chaos.³⁵

ZASP's accreditation as a co-composed piece in the documentation Zinovieff and Sutcliffe produced alongside it appears to support the idea that a computer could enable newly collaborative ways of composing not only within the machine itself but for the composers, musicians and engineers using it.

However, human collaborations come with certain problems. Although neither man was a trained composer, Zinovieff regarded himself as more knowledgeable about music, with Sutcliffe as the more experienced programmer. In a letter that is undated, but can be estimated as being from early- to mid-1968, Zinovieff expressed concern that, 'this composition must be by both of us at all stages although respecting also at all stages each others' specialist knowledge'. The letter begins,

I am a little worried about our venture and the relative parts we are to play in it. You must know that the amount of actual composition [and] realisation that I can get done is very few minutes a week. This means that anything that I do realise must in effect be my composition. In this case I am quite prepared to let it be our composition but I must have a large say in some of the musical principles involved. This is not to say that I distrust your musical ability but that I am a composer and also I know about what electronic sounds are like in juxtaposition.³⁶

That such a concern should arise at all highlights the unusual nature of the project. There were few, if any, precedents of collaborative compositions with a computer for the duo to draw upon in order to define their own roles, and it is perhaps not surprising that there was some conflict on this issue. In the following chapter, I will consider in

³⁵ MS/2160, ZASP Papers.

³⁶ Peter Zinovieff to Alan Sutcliffe, n.d. MS/2160, ZASP and Spasmo. *Spasmo* is the collective title of a number of computer-generated poems written by Sutcliffe for one of the Redcliffe Concerts in 1969; the poems were to be read aloud by the audience. Such 'people procedures', as Sutcliffe called them, were considered to be an outgrowth of computer arts, as Jasia Reichardt writes, in relation to the work of artist Charles Csuri, who devised similar spectator-centred artworks. Reichardt, *Cybernetics, Art and Ideas*. (New York: New York Graphic Society, 1971), p. 35.

more detail the ways in which the electronic music studio provoked new definitions of the roles undertaken by musical practitioners.

Whatever its composers' view on the work's creative authorship, *ZASP* enabled Sutcliffe to forge connections in the new fields of computer music and art. He submitted the piece to a festival of Computerized Music and Art held by the Association of Computing Machinery in Las Vegas, where it was played in September 1968, and began a correspondence with Max Mathews of Bell Labs.³⁷ It was he rather than Zinovieff who attended the IFIP Congress in Edinburgh, while Zinovieff, holidaying in Raasay, wrote to Sutcliffe sketching out plans for future work that would improve on what he saw as the 'lack of tension, surprises or the dullness of timbre' of the *ZASP* program.³⁸ But although Zinovieff was critical of *ZASP*, the experience of composing it had brought him into the orbit of bodies such as IFIP as well as other composers and technologists working with computers. In October 1968 he and Sutcliffe attended the International Week for Experimental Music at the Technical University in Berlin, where Zinovieff gave a paper entitled 'The Use of Small Computers in the Production of Electronic Music' as part of a panel on computer music that also included Pietro Grossi, Gottfried Michael Koenig and Max Mathews.³⁹

2.3.2 The Computer Arts Society, Cybernetic Serendipity and Event One

At the IFIP Congress Stanley Gill suggested that Sutcliffe should take advantage of the interest in computer composition there to set up some kind of computer music group. Sutcliffe agreed, although he felt that such a group should represent all art forms, not just music.⁴⁰ While still in Edinburgh, he began to collect names of interested parties, and on returning home, sent out his proposal for a Computer Arts Society. The Computer Arts Society held its first meeting at University College, London, in September 1968, with Sutcliffe, George Mallen, John Lansdown and Gustav Metzger in attendance, and was formally launched in March 1969 at the Royal College of Art. Metzger volunteered to edit a bulletin for the Society, and produced *PAGE*, initially a two-sided A4 newsletter which expanded in later years.

³⁷ MS/2160, *ZASP* papers.

³⁸ *Ibid.*

³⁹ Sutcliffe, 'Patterns in Context', p. 184

⁴⁰ *Ibid.*, p. 178.

As these preliminary meetings got underway, the Institute of Contemporary Art's exhibition of art and technology, *Cybernetic Serendipity*, curated by Jasia Reichardt, was still attracting visitors, having opened in August that year. Many of the Computer Arts Society's new members were featured in some capacity in the exhibition – including Zinovieff, who had lent his PDP-8/S and various other devices from EMS to the show. *Cybernetic Serendipity* played an important role in articulating the creative potential of cybernetics, bringing together numerous works that were informed by the central cybernetic theories of information and feedback.

Cybernetic Serendipity's focus was broad, both internationally and in its definition of what constituted cybernetic and computer art – for it could be argued that, although the exhibition's title was subtitled 'The computer in art' in a special edition of *Studio International* produced to accompany it, not everything on display was computer-related. But it reinforced two important points that, for many visitors to the exhibition, would not have been self-evident: firstly, that the computer was not only a tool for science and industry but a medium, like film, that could be used to produce or control image, sound and three-dimensional design; and secondly, that cybernetic art welcomed the inclusion of designers, makers and engineers alongside fine artists.

Cybernetic Serendipity was not without its critics: Gustav Metzger, writing in *Studio International*, called the show a 'technological funfair' which gave no indication of the problematic associations between computing and modern warfare and the potential misuses of cybernetics and machine intelligence.⁴¹ However, Jasia Reichardt's curatorial pluralism chimed with the Computer Arts Society's support of not only fine artists but also those working in applied arts and design. In October 1968, Sutcliffe wrote to a potential supporter,

Computers in applied arts can help us reconcile the need for large scale production of goods with our need for individuality and variety. In pure arts, computers can lead to new forms of expression as well as helping artists with their practical needs for information processing.⁴²

⁴¹ Gustav Metzger, 'Automata in history', *Studio International*, March 1969, p. 108. Later reassessments such as Rainer Usselman's article 'The Dilemma of Media Art: Cybernetic Serendipity at the ICA, London' highlight similar concerns (Usselman in *Leonardo* 36:5 (2003), pp. 389–396)

⁴² MS/2160, ZASP Papers.

In the introduction to *Event One*'s programme, CAS's founders stated that one of the Society's functions was to respond to this need for individuality and variety in art and design, writing that, 'we can now, with computers, reverse the tendency for mechanisation to mean standardisation, greyness, uniformity and de-humanisation'.⁴³ In the next chapter, we will see how these stereotypes about mechanisation also affected public perceptions of computer music.

Event One took place on 29 and 30 March 1969 in the Gulbenkian Hall at the Royal College of Art. Its organisers put together a full programme with demonstrations and performances taking place throughout the weekend.⁴⁴ As Metzger wrote in the first issue of *PAGE*, published shortly after Event One, one of the weekend's great successes was its presentation of computers at the event itself: Imperial College loaned a PDP-7, teletype terminals and other equipment were lent by various companies, and ICL arranged a telephone link with Peter Zinovieff's PDP-8/S.⁴⁵

The event's 23-page programme contained short essays or programme notes under the headings Film, Sculpture, Graphics, Architecture, Dance, Theatre and Music; literature was not included, although Sutcliffe contributed some computer-generated poetry he had devised for the Redcliffe Concert of February that year. This was listed under Music, alongside works by Pietro Grossi and a demonstration of the PDP-8/S by Peter Zinovieff and David Cockerell. Using a light pen on a screen to specify pitch and volume, visitors were able to generate musical patterns to be played back by the computer. The exhibit was intended to show 'one aspect of working in a modern computerized electronic music studio' and, to emphasise this, EMS placed an ad on the back cover of the programme, offering services including consultancy, design and manufacture, studio installation, equipment hire and concert organisation.⁴⁶

Metzger wrote in his review of the event for *PAGE* of the many sounds that could be heard as one walked around the exhibition. These were by no means produced only by the Music exhibits: films and performances incorporated sound, and there were light/sound works on show by artists such as Philip Hodgetts, Adrian Nutbeam and John Bucklow, and John Lifton, whose 'computer controlled light and sound

⁴³ *Event One* (London: Computer Arts Society, 1969), p. 3.

⁴⁴ Catherine Mason, 'The Fortieth Anniversary of Event One at the Royal College of Art', paper given at Electronic Visualisation and the Arts (EVA) London Conference (July 2009), p. 4. www.catherinemason.co.uk/

⁴⁵ Gustav Metzger, 'Opinion', in *PAGE* 1 (1969), p. 1.

⁴⁶ *Event One* (London: Computer Arts Society, 1969), p. 13.

environment’ translated visual signals into audio ones and vice versa, enabling sound – which Metzger described as ‘electronic music’ – to be produced by light sensors that visitors would set off by their movements in the space. Lifton described the ‘light to sound’ part of the environment as ‘the first musical system where no information needs to be passed from the composer to the performer’, displaying a ‘dispersed’ approach to authorship that aligned with principles of cybernetic systems as well as ideas of interactivity, then in their earliest stages.⁴⁷ Yet despite the importance of collaboration and cross-disciplinary practice in these early stages of the Computer Arts Society, it was still felt necessary to arrange Event One, on paper at least, into categories of practice – such as music, sculpture and so on – that could be easily understood, even if the works themselves seemed to trouble those categories. It appeared that disciplinary boundaries, while easy to transgress temporarily, were not so easy to shift in any meaningful sense.

The recent research carried out by the CACHE (Computer Arts, Contexts, Histories, etc) research group⁴⁸ into this early stage of computer arts in the UK indicates that there was very little communication between communities of computer artists and musicians, even if some artists worked with sound; the connection between EMS and the Computer Arts Society was, therefore, somewhat anomalous. While Alan Sutcliffe maintained his personal interest in music and *PAGE* occasionally ran reviews and features on electronic music, and helped to advertise EMS products, the Computer Arts Society’s focus remained on the visual and applied arts. What, then, is the significance of this relationship?

It is notable that in one of the proposals for a national electronic music studio that he put before the British Society for Electronic Music in 1969, Zinovieff outlined not an electronic music studio but a ‘computer arts studio’ that could be used by those working with ‘ballet, graphics, sculpture, poetry and other writing, [and] theatre’ as well as – or in conjunction with – music.⁴⁹ This suggests the influence of Sutcliffe and the then-newly formed Computer Arts Society, but also, like the Unit Delta Plus concert a few years before, proposes a future for computer music as a form of, or at least a close relative of, media art, rather than a subgenre of contemporary art music. Zinovieff’s proposals were unsuccessful for a number of reasons, but we can speculate

⁴⁷ John Lifton in *Event One*, p. 15; Mason, ‘The Fortieth Anniversary...’, pp. 7–8.

⁴⁸ See <http://www.bbk.ac.uk/hosted/cache/>

⁴⁹ Zinovieff to BSEM. MS Mus.1803/7/4 (correspondence), Hugh Davies Archive, British Library.

that one of these was that such a cross-disciplinary, computer arts-influenced model for a studio did not align with the aims of new music organisations that I will introduce later in the chapter, with their focus on composers, works and concerts. In some ways, his ideas for a national studio had more in common with an organisation like John Lifton's Institute Research in Arts and Technology (IRAT), which was established in 1969 in north London.⁵⁰

Alan Sutcliffe provided Peter Zinovieff with a necessary connection to computing in the UK, both through his work in the computing industry and his position in the new field of computer arts, which, in principle at least, included music within its remit. However, the accessible ethos of the Computer Arts Society did not translate into a deep commitment to music, nor could it call into being the kinds of physical spaces in which lasting connections between computer arts and electronic music could be formed, if these were not already available through the existing structures for the education, practice and performance of art and music. While EMS advertised its services to computer artists at Event One, this new art form – still establishing its critical parameters and dependent, due to the cost, inaccessibility and impracticability of computers, on pragmatic connections with the computing industry (such as Sutcliffe's position at ICL) or science departments of universities – did not readily attract composers and musicians. Therefore, while some of the conventions of concert music in the 1960s conflicted with the cross-disciplinary ideas and practices of computer and other media arts, it was within the former milieu that EMS's founders focused their efforts to advocate for electronic music and increase its public profile through concerts, the formation of organisational bodies, and published articles.

2.4 Electronic music and the new music establishment: Tristram Cary, the Redcliffe concerts and the Royal College of Music

2.4.1 EMS at the QEH

In January 1968, compositions by Peter Zinovieff and Delia Derbyshire were among those performed at another concert of electronic music, this time at the newly opened Queen Elizabeth Hall, part of London's South Bank Centre. The concert was produced by Zinovieff with Tristram Cary, the composer, educator and broadcaster whom

⁵⁰ Mason, 'The Fortieth Anniversary...', p. 7).

Zinovieff had first met in 1966.⁵¹ As well as Zinovieff and Derbyshire, the programme included works by Cary, Ernest Berk, George Newson, Jacob Meyerowitz, and Daphne Oram and Ivo Walworth, who collaborated on a piece for tape and piano.

This concert was a much larger event than the intimate performance put on by Unit Delta Plus at the Watermill theatre. Its inclusion in the Redcliffe series of Concerts of British Music placed electronic music in a national context of contemporary concert music. Set up by composer and author Francis Routh, the Redcliffe Concerts began as an occasional concert series and festival held at St Luke's Church in Redcliffe Gardens, Chelsea, between 1957 and 1961. The aim of the series was to promote new British composition, which the founders felt had been neglected by local orchestras and concert promoters in favour of the more prominent continental European composers. Subsequently, the Redcliffe Concerts were held at the Arts Council, which supported the venture via the London Orchestral Concert Board. When the Queen Elizabeth Hall was opened in 1967, the concerts moved to the South Bank Centre, where they continued until 1989.⁵²

While the Concert of Electronic Music showed that a small number of British composers were producing electronic works, Routh noted that it also highlighted the technical limitations most of them were facing. Aside from Derbyshire's *Pot-Pourri*, which had been made at the BBC Radiophonic Workshop, every other piece had been made in a private studio, most of which contained fairly rudimentary equipment. The result was that, 'Some of the tapes were merely sound effects, at a primitive stage of development.'⁵³

Yet Routh acknowledged that the event had been one of the most notable Redcliffe concerts, in terms of sheer numbers of attendees. In 2012, he recalled,

A sell-out, a packed Elizabeth Hall, a taxi queue extending to Waterloo station, and reviews far longer and more detailed than was normally the practice ... all reflecting a high level

⁵¹ Tristram Cary, *Autobiography*, n.d. Ch. 16. This listing, here and throughout this thesis, refers to Cary's unpublished autobiography, which is available only as a series of Word documents, one per chapter. I have therefore given chapter numbers rather than page numbers. Used with permission of Jane Cary.

⁵² Francis Routh, 'Redcliffe Concerts of British Music' (2012) www.francisrouth.net/redcliffe/wordpress/?page_id=1188

⁵³ Francis Routh, *Contemporary British Music: The twenty-five years from 1945 to 1970* (London: Macdonald and Co., 1972), p. 299.

of public curiosity, fed by the novelty value of the new technology.⁵⁴

Routh's suggestion that the attraction of the concert was not purely musical – that audiences were attracted to the spectacle of a performance using new and unfamiliar technology – is supported by Tristram Cary's account of the thinking behind the event. One of its primary motives, he writes, was to 'give [Zinovieff's] PDP8 a public debut', resulting in 'the first ever live computer performance without tape or any music recording medium'.⁵⁵ The concert functioned not only as a showcase for new electronic music but also as a demonstration of the electronic music studio itself.

Zinovieff's PDP-8/S computer was revealed to the audience as they took their seats after the interval. Film footage of the concert, shown on the BBC TV programme *Tomorrow's World*, shows Cary announcing from one of the boxes that we are about to see 'a true live performance, in the sense that no magnetic tape is being used at all'. He continues,

Furthermore, the computer has a choice at various stages in the procedure, and the piece therefore comes out different every time it's played. The performance you're about to hear is therefore unique, and unrepeatable. First of all, checks are made to see that the composition is correctly loaded into the computer. The computer is started, and will carry out the performance unattended.⁵⁶

The footage shows Zinovieff operating switches while an unnamed woman appears to type on a teletype keyboard. Once the music begins, they exit the stage.

It is a highly staged performance that both confounds expectations – in that it shows a machine 'playing' a composition – and reinscribes the idea of the computer as a powerful machine that can automate any process, even such creative ones as composing and performing music. Taken out of its usual workplace setting to assume the role of the musical performer, the presence of the computer gestures towards a future in which it will play a greater role in people's lives, not only in factories and offices, but in the realms of art and entertainment. In this respect, the concert also

⁵⁴ Routh, 'Redcliffe Concerts of British Music'.

⁵⁵ Cary, *Autobiography*, Ch.16.

⁵⁶ *Tomorrow's World* (1968). BBC 1, 6 March, 1968.

functioned as a scientific-technological exhibit, and it is this aspect which may have caught audience's imaginations and contributed to the success of the concert. It is interesting to note that, rather than presenting the computer as part of an interactive art practice, as it would be at Cybernetic Serendipity and Event One, Cary's announcement has something about it of the magic show, or the 'electro-musical' spectacles of the Victorian music hall described by Dan Wilson.⁵⁷ As the *Daily Telegraph*'s reviewer Martin Cooper wrote the following day,

To judge from the crowds at the Queen Elizabeth Hall last night it would seem that there are many people who would never dream of attending a conventional avant-garde concert yet are interested in the possibilities of electronic music.⁵⁸

Stanley Sadie from *The Times* acknowledged the appeal of electronic music, but also described it as 'a snare', remarking, with an attitude that, as we shall see in further chapters, was fairly common at this time, 'It is easy enough to conjure up aural blandishments; but to produce real music you need to be a real composer, and to observe certain disciplines.'⁵⁹

Tristram Cary was not himself deeply invested in computing at this time: like many composers, he could see the potential in using digital methods to make electronic music, but the prospect of working with the slow, unwieldy and prohibitively expensive computers of the 1960s was neither appealing nor practical.⁶⁰ However, he was committed to bringing contemporary music, however it was devised and performed, to a wider public, describing his role on the Executive Board of the Composers' Guild of Great Britain as 'to nag and bully [the] Third Programme to broadcast more music by Living British Composers (LBC for short)'.⁶¹

Cary was also adamant that electronic music should be played in live settings, and not confined to the radio. He maintained that composers benefited from being able to control playback, and to hear their work through a better sound system than most

⁵⁷ Dan Wilson, 'The Electric Music Hall', *The Wire* #364 (June 2014), pp. 32–39.

⁵⁸ Martin Cooper, 'Limitless Palette of Electronic Music', *Daily Telegraph*, 19 January, 1968.

⁵⁹ Stanley Sadie, 'More Experiments With Sound', *The Times*, 11 January, 1968.

⁶⁰ Cary, *Autobiography*, Ch.16.

⁶¹ Cary, *Autobiography*, Ch.15.

radios allowed; the live context also allowed the composer to explore the creative use of speaker placement and sound spatialisation.⁶²

The live presentation of electronic works also encouraged audiences to engage with those works as autonomous creations, rather than as sound effects or incidental music for TV or radio drama. Cary was both pragmatic about and quite defensive of his functional music for TV and film,⁶³ and in his desire for electronic compositions to be presented as concert works one senses that behind the quite reasonable technical points outlined above was also an assertion of the electronic composer's artistic status. If this music could be regarded by audiences as 'real' music, then it follows that its creators would be seen as 'real' composers – and remunerated accordingly by bodies such as the Performing Rights Society. Cary, who had been credited as a 'Sound Effects Deviser' rather than a composer when he made the first piece of electronic music for British radio in 1955,⁶⁴ was well aware of the distinction that was often made between the creation of music and the arrangement of sound, and the value judgements that were placed on those pursuits, which delegated talented composers such as Delia Derbyshire to roles such as 'studio manager' or creator of 'special sound', distinctions that I will explore in more detail in Chapter Five. The Concert of Electronic Music subtly addressed this disparity by presenting the works of a number of composers more usually associated with TV, film and library music – not only Cary, but also Ernest Berk, Daphne Oram and Delia Derbyshire.

The concert's success also helped to consolidate Cary's relationship with Zinovieff, and he would continue to be part of EMS's activities over the next half-decade. Cary brought the musical establishment's attention to EMS through his involvement and contacts in education and public arts bodies; these same contacts would be valuable when marketing the EMS VCS3 synthesizer, as well as other EMS products, to schools and colleges, and the BBC.⁶⁵

⁶² Tristram Cary, *Illustrated Compendium of Musical Technology* (London: Faber & Faber, 1992), p.xxiii.

⁶³ About his colleagues in the Composers' Guild who felt film music was beneath them, Cary wrote, 'if they'd been offered a feature film I'm fairly sure it wouldn't have taken them long to dismount from their high horses – after all, Vaughan Williams and Walton did some excellent film music' (Cary, *Autobiography*, Ch.15).

⁶⁴ Louis Niebur, *Special Sound: The Creation and Legacy of the BBC Radiophonic Workshop*. (Oxford: Oxford University Press, 2010), p. 221, n32.

⁶⁵ Pinch and Trocco, p. 273; Niebur, p. 131.

2.4.2 Tristram Cary and plans for a national studio

Tristram Cary was born in Oxford in 1925. His university education – initially in sciences – was interrupted by the Second World War, in which he served in the Royal Navy as a radar technician. After the War, Cary left the Navy determined to become a composer and in 1948 began his studies in composition at Trinity College of Music, London. Having been a keen musician since childhood, he claimed to have missed making music during his wartime service; at the same time, his training in radio helped to generate an interest in electronic sound, leading him to conclude that ‘a recorded sound could be a creative statement in itself’.⁶⁶

Cary was first employed by the BBC to work as a composer for the then-newly established Third Programme in 1954, and in 1955, as mentioned earlier in this chapter, he composed the BBC’s first electronic score for a radio drama called *The Japanese Fishermen*.⁶⁷ Cary’s first electronic pieces were made in a small studio in his home in Earl’s Court, West London.⁶⁸ He built his own devices or adapted existing ones, in the process ‘exchanging the roles of technical inventor and composer’.⁶⁹ When he and his family moved to Fressingfield, Suffolk, in the early 1960s, Cary was able to construct a bigger studio in a building next to the house in which the Carys lived until the early 1970s. Here he composed themes for science fiction film and TV dramas including *Dr Who* and *Quatermass and the Pit*.⁷⁰ In 1967 he also composed the music for an installation in the British Pavilion at the Montreal Expo, working with architect Theo Crosby.

Cary liked to think of himself as an independent artist, unaligned with – and unsuited to being part of – any particular organisation or company; his first response, on being contacted by Zinovieff about working together, was that, ‘I am not much of a joiner’.⁷¹ Yet his self-professed independence did not equate to a rejection of the musical establishment, as he was involved in various composers’ bodies and, his autobiography relates, he readily visited other studios, conferences and other events abroad. This interest in international developments in electronic music helped to foster

⁶⁶ Cary, *Illustrated Compendium of Musical Technology*, p. xvi.

⁶⁷ The music for the programme was created in Cary’s home studio using an oscillator and 78 rpm discs, cut with a lathe that Cary had purchased after leaving the Navy. See Cary, *Autobiography*, Ch.15.

⁶⁸ Cary, *Autobiography*, Ch.14.

⁶⁹ Gabrielle Smart, *Tristram Cary: Scenes from a Composer’s Life* (unpublished MA thesis, University of Adelaide, Elder Conservatorium of Music, 2008), p. 42.

⁷⁰ *Quatermass and the Pit*, dir. Roy Ward Baker (1967).

⁷¹ Cary, *Autobiography*, Ch.16.

a concern about how the UK could compete with the rest of the world on this front. In 1966 Cary, who was an enthusiastic writer, published several articles in which he sought to promote electronic music in a number of ways. Firstly, he wanted to encourage composers to experiment with electronic sound, reassuring them, in an article for the Composers' Guild's magazine, *The Composer*, that it was not as hard to do as they might expect. He also advocated for electronic composition to be recognised and taken seriously by the new music establishment.

Cary believed that the best way in which this latter aim could be achieved was to set up a national electronic music studio. His article in the *Musical Times*, printed in April 1966, frames the lack of a studio as an urgent matter:

No one seems to notice (or care) that Britain is rapidly losing another race among so many lost races – although [...] it would not be difficult even now to lead the world in an important and fascinating field of study.⁷²

The national studio that Cary envisaged would, he writes, be an institution in which the study and composition of electronic music is carried out alongside and in collaboration with research into 'ultra-sonics, acoustics of buildings, musical instrument design, microphones', and a number of other areas. This ambitious vision is followed by a more realistic one, as Cary suggests that a national studio could be established within a selected university's music department; but he still suggests that this studio have input from and be used by both musicians and scientists.

Cary's letter was one of the factors that prompted the formation in 1967 of an Electronics Sub-Committee of the Society for the Promotion of New Music (SPNM), led by composers Hugh Davies and Don Banks.⁷³ SPNM, founded in 1943, had had its key role in supporting and promoting emerging British composers challenged by the rise of the Third Programme and increased Arts Council funding for living artists during the 1960s. However, it had been re-energised in 1967 by an unexpected private

⁷² Tristram Cary, 'Electronic music – A Call for Action', *The Musical Times* 107: 1478 (1966), pp. 312–313.

⁷³ Nicola Anne Candlish, 'The Development of Resources for Electronic Music in the UK, with Particular Reference to the bids to establish a National Studio' (unpublished doctoral thesis, University of Durham, 2012), p. 143.

donation of £100,000 and was looking to support new projects.⁷⁴ In May 1968, the executive committee of SPNM met to discuss electronic music in the UK; both Cary and Zinovieff were present at the meeting.⁷⁵ Don Banks's minutes note that:

Mr Zinovieff said he was willing to offer his studio, which contained about £20,000 worth of equipment including a computer, as the basis for a large studio. . . He thought it was necessary to think on really big lines. . . A possible approach was for us to begin with Mr. Zinovieff's studio, to which we could add some money. Support from National organizations could then be used to build this into a studio of the size which was evidently required.⁷⁶

In 1969, members of the Electronics Sub-Committee established the British Society for Electronic Music (BSEM), with Peter Zinovieff taking the role of Hon. Secretary and Peter Maxwell Davies acting as the Chair. Cary was a member, along with Harrison Birtwistle, who was by this time working with Zinovieff on their first electronic collaborations; and Keith Winter of the Arts Council, who would go on to set up a computer-based studio at Cardiff University in 1972. A concert launching the BSEM was organised by SPNM in June 1969 at the Purcell Room, London, featuring works by, among others, Milton Babbitt, Roberto Gerhard, and Justin Connolly in collaboration with Peter Zinovieff; and instrumentalists from Birtwistle's ensemble, the Pierrot Players. The concert gained a mixed review from the *Musical Times's* Dominic Gill.⁷⁷ At BSEM's inaugural meeting, it was decided that,

the principal object should be the founding of a major electronic music studio in London with the intention of providing composers with the opportunities that are available in the leading electronic centres in Europe and America.⁷⁸

Cary's *Musical Times* article was an important catalyst in this campaign for a national studio. Yet his proposal for an institution which brought together music, science and

⁷⁴ Benjamin Wolf, 'The SPNM 1943-1975: a retrospective', *The Musical Times*, 54: 1925 (2013), 56-7.

⁷⁵ Candlish, p. 148.

⁷⁶ Don Banks quoted in Candlish, p. 149.

⁷⁷ Dominic Gill, 'Music in London,' *The Musical Times*, 110: 1518 (1969), pp. 852-53.

⁷⁸ Candlish, p. 153.

engineering seems to have faded into the background as the idea of the national electronic music studio was taken up by composer-led bodies such as SPNM. However, I would like briefly to consider this aspect of Cary's proposal, which, in hindsight, appears prescient of research- and technology-focused institutions such as IRCAM, which opened in 1977; and, indeed, Keith Winter's studio at the University of Cardiff, which was devised as a joint project by the Music and Physics departments of the university.⁷⁹ Like Zinovieff's idea for a 'computer arts' studio, Cary's ambitious proposal recognised that electronic music was not only a serious form of music, but also a field that could both benefit from and be valuable to other areas of academic expertise. It also suggests that Cary might have had in mind existing academic departments such as the pioneering Experimental Music Studio at the University of Illinois, which had been set up in 1958 by Lejaren Hiller and combined teaching in electronic music with research into acoustics and computer sound analysis.⁸⁰ Cary, with a background in studying science and practical experience of working with sound-making technology, would have seen little reason not to bring these areas of interest together.

At this time, composers themselves were reframing their practice in terms suggestive of both visual arts and the electronics or physics lab, as Wolf notes:

Where earlier generations might have referred to elements such as melody and harmony, SPNM composers of the 1960s were more likely to discuss the manipulation of 'musical material'.⁸¹

Yet in reality it was hard to shift new music's social, cultural and academic conventions, which articulated class as well as aesthetic differences. Cary addressed some of these stereotypes in an article titled 'Sproggletaggle', a word that, he writes, 'was used during the War as a single-word deflator, to lower the sluice gates on dangerous outbursts of esoteric technical wish-wash'. He continues,

⁷⁹ The studio in Cardiff was funded in 1970 by a grant of £15000 from the Leverhulme Trust for a project 'covering the area between Physics and Music'. From Daphne Oram Archive, ORAM/1/2.

⁸⁰ Lejaren Hiller, 'Music Composed with Computers – a Historical Survey', in *The Computer in Music*, ed. by H. Lincoln (Ithaca and London: Cornell University Press, 1970), p. 49.

⁸¹ Wolf, p. 64.

There is every bit as much sprogletaggle in the process by which you write a full score as there is in the process by which some of us emerge, red-eyed but triumphant, with a tape. It is just that by tradition music shop is U and OK, while electrical shop belongs to dreadful fellows in overalls.⁸²

While there is obviously some exaggeration for humorous effect at work here, Cary's text alerts the reader to the ways in which class dynamics might be played out in electronic music, at least in the circles of the Composers' Guild and SPNM. With an upper-middle class background and literary pedigree via his well known novelist father, Joyce Cary, Tristram Cary was able to disregard the class distinction between the composer and the engineer, or at least make light of it.⁸³ He and Zinovieff shared an ability to undertake technical and artistic work without being unduly bothered by the stereotypes associated with those roles. It is hard to say how much of this was due to their class privilege and how much to the unusual nature of what they were actually working on, for which there were few precedents; the likelihood is a combination of the two.

Although Cary and Zinovieff were unable to establish their speculative national studio within any higher education institution in the UK, Cary's advocacy for electronic music soon brought him into the area of music education in a slightly different way. In 1966 the director of the Royal College of Music, Keith Falkner, visited the Staatliche Hochschule für Musik in Cologne, where students were offered tuition in electronic music in a studio set up at the school. The experience confirmed to him that RCM should include the teaching of electronic music in its syllabus, and on his return he began sounding out contacts at EMI as well as the BBC Radiophonic Workshop and the neighbouring Imperial College for information on how to set up an electronic music studio.⁸⁴ David Bicknell of EMI showed Falkner Cary's *Musical*

⁸² Tristram Cary, 'Sprogletaggle', *The Composer*, 18 (January 1966), p. 6.

⁸³ As Gabrielle Smart suggests in her description of Cary's position within London media and music circles, his connections allowed him the freedom to proclaim an independence that might not have been afforded to others. See Smart, 'Tristram Cary', p. 35.

⁸⁴ Guy Warrack, *History of the Royal College of Music (Vol 2), The First Eighty-five Years: 1883-1968 – and Beyond* (London: Royal College of Music, 1969), p. 453.; RCM Archive, Correspondence 1966–67.

Times article; and in 1967 Falkner approached Cary to ask if he would be interested in the role of ‘composer-instructor’ at a new electronic studio to be set up at RCM.

By May 1967 Cary had devised a syllabus for the course and the first classes in electronic music were taught in October of that year,⁸⁵ even though the building of the studio was still in progress. Lawrence Casserley, a student who would go on to become the studio director when Cary left in 1972, and one of the earliest users of the VCS3’s prototype, recalled that the class was taken on visits to Cary’s Fressingfield studio and to Zinovieff’s studio in Putney while they waited for the RCM studio to be completed.⁸⁶

Warrack cites the RCM studio as ‘first electronic studio to be opened in any London school of music’,⁸⁷ and Cary confirms that it was the first ‘teaching studio’ in the capital.⁸⁸ However, the studio at Goldsmiths, University of London, was developing in parallel with RCM’s, and its first courses, run by Hugh Davies, were delivered in the spring term of 1968.⁸⁹ As anticipated by Falkner when he first approached Cary to run it, the RCM studio prefigured a larger, UK-wide effort to introduce electronic music into education through music colleges and university music departments, which continued throughout the 1970s.

Cary continued teaching at RCM until his emigration to Australia in 1974.⁹⁰ His role at RCM allowed him to establish himself as an electronic music educator, a position that became useful as EMS developed its synthesizer business. Cary’s credentials were displayed on marketing materials such as a covering letter that was sent out with EMS brochures to universities that might become customers. Signed by

⁸⁵ Warrack, p. 455.

⁸⁶ Lawrence Casserley, ‘Reflections on Ten Years of Electronic Music at the RCM’, *RCM Magazine*, (Autumn 1979) p. 80.

⁸⁷ Warrack, 1969, p. 455.

⁸⁸ Tristram Cary, *Autobiography*, Ch.15.

⁸⁹ In an article on the history of Goldsmith’s EMS, Davies and his colleagues stated that it was ‘the first such facility in any institution of higher education in Britain (soon followed by York University and the Royal College of Music in London)’. The studios at RCM and Goldsmiths can be said to be contemporaneous due to their rather ad hoc beginnings; for example, both began classes before a studio had finished being installed, and the Goldsmiths studio was initially a temporary arrangement that had to be packed away after use. What is perhaps more interesting is there that appears to have been little communication between the two institutions and, to my knowledge, neither collaboration nor sharing of resources was ever mooted. See David Burnand, Hugh Davies, and Benedict Sarnaker, ‘Electronic Music Studio: Goldsmiths’ College, University of London’, *Sound On Sound*, 2: 4 (1987), www.muzines.co.uk/articles/electronic-music-studio/1514

⁹⁰ Cary’s move was precipitated by a visit to RCM from George Loughlin of Melbourne University, who wanted Cary to teach the Melbourne students how to use the University’s newly purchased EMS Synthi 100 (see Cary, n.d., Chapter 17; Smart, ‘Tristram Cary’, p. 107)

Cary, with an impressive list of qualifications ending in ‘Professor, Electronic Music, Royal College of Music’, the letter conveys Cary’s position as someone concerned with ‘higher education in music’, and assures the addressee that the Synthi range is used at RCM, among many other studios. ‘Nearly all young composers are interested in using electronics’, he writes, ‘and no academic establishment can for long now remain without some means of satisfying this interest’.⁹¹ Overall, Cary’s presence within EMS strengthened links both with organisational bodies of new concert music in London and a growing network of academic electronic music studios.

2.5 Conclusion

Reflecting in the early 1970s on the formation of Computer Arts Society, Alan Sutcliffe justified the initial openness of the Society to any kinds of art-making and design: ‘No matter how trivial, I thought it was significant that someone had used a computer to make something’, he wrote in *PAGE 13*.⁹² The anthropologist Jonathan Benthall, one of the few contemporary critics to address computer arts seriously,⁹³ saw this as one of the weaknesses of CAS and computer arts more generally, predicting that at some point a level of criticality had to be introduced, or at least a ‘criterion of merit’.⁹⁴ Others perceived its lack of criticality more sympathetically, such as the collector Patric Prince, who proposed that computer art could be seen as a form of ‘volksart’.⁹⁵ However, with computer art itself a contested term – ‘a provocation’, as Benthall suggested, given the common perception of a discrepancy between ‘computer’ and ‘art’ – any organisation setting itself up to support the form had to spend time establishing its validity, before starting to address in any depth the aesthetic qualities of individual works.

A similar problem was encountered by the early proponents of electronic and, especially, computer music described in this chapter. The resources required to make this music in the late 1960s were so highly specialised, costly and space-dependent that Zinovieff, Cary and Sutcliffe had to prioritise advocating for support and facilities

⁹¹ RCM Archive, c.1971.

⁹² Sutcliffe quoted in Jonathan Benthall, *Science and Technology in Art Today*. (London: Thames & Hudson, 1972), p. 51.

⁹³ Catherine Mason, *A Computer in the Art Room: The Origins of British Computer Arts 1950-1980*. (London: Quiller Press, 2008), pp. 103, 107.

⁹⁴ Benthall, p. 51.

⁹⁵ Mason, p. 105.

alongside developing the music itself, which, as Zinovieff's assessment of *ZASP* suggests, often fell short of expectations. To make this advocacy effective, it had to be clear what was required, for whom and from whom. This, I argue, led in part to the positioning of EMS in relation to new music organisations and institutions such as SPNM, the Music department of the Arts Council, the Redcliffe Concerts series and others, despite Zinovieff's earlier excursions into the emergent media arts and Sutcliffe's continuing involvement in computer art.

Formalising EMS's activities as explicitly musical, via events such as the Redcliffe Concerts, brought EMS and electronic music as a whole to the attention of classical music critics, and to an audience more accustomed to orchestral or chamber music. However, it is interesting to draw a comparison between the first Redcliffe Concert of Electronic Music in 1968 and the Watermill concert of 1966. In the latter, electronic music was positioned in dialogue with visual art. The Redcliffe Concert, rather than using projections and sculpture to suggest perceptual relationships between sound and image, included performative aspects that demonstrated the use of technology in a far less abstract way, such as the 'performance' by Zinovieff's computer which presented it as a kind of large musical automaton that, even if most of the audience had no idea how it worked, appeared nonetheless to be a machine that made music.⁹⁶ Here, we might want to think about how certain spaces, such as a concert hall, produce and define and are in fact 'formative of the sounding and resounding of music'⁹⁷.

As the 1960s progressed, it became more likely that studio-based electronic music, rather than forming an alliance with visual art, would become part of the existing structure of contemporary music education, promotion, funding and concert performance in the UK, as Cary had advocated. In order for EMS to thrive and develop, its founders needed to forge relationships within this structure. Cary's role in enabling and sustaining these relationships was crucial to the development of EMS, as

⁹⁶ It should be noted that a subsequent Redcliffe Concert of Electronic Music, in 1969, featured interactive works by Alan Sutcliffe, and 'happening'-like elements were added to some of the programmes (as described by Zinovieff in Pinch and Trocco, p. 279), so the influence of performance and media art was not entirely absent from these events; cleverly designed programmes by Nicholas Dimbleby added to the sense of an artistic event. However, the context of the Redcliffe Concerts and the Queen Elizabeth Hall could not help but create expectations of composed classical works performed in a concert setting.

⁹⁷ Andrew Leyshon, David Matless, and George Revill (ed.), *The Place of Music*, (New York: Guilford Press, 1998) p. 5; see also Christopher Small on the history, design and cultural politics of the modern concert hall. Small, *Musicking*, chapters 1 and 2.

was the presence of the increasingly prominent composer Harrison Birtwistle, whose relationship with EMS will be described in the next chapter.

In this chapter I have explored some of the social, technological and artistic currents that gave EMS its particular character during the years in which it was becoming established. In the following chapter, I look more closely at the studio itself and the new roles, practices and challenges generated by creating music with computers in the late 1960s.

CONCERT of ELECTRONIC MUSIC

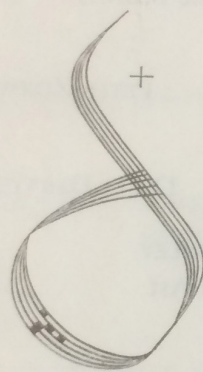

UNIT
DELTA
PLUS

WATERMILL THEATRE

BAGNOR

Saturday 10th. September, 1966

7-0 p.m.

Concert sponsored by UNIT DELTA PLUS



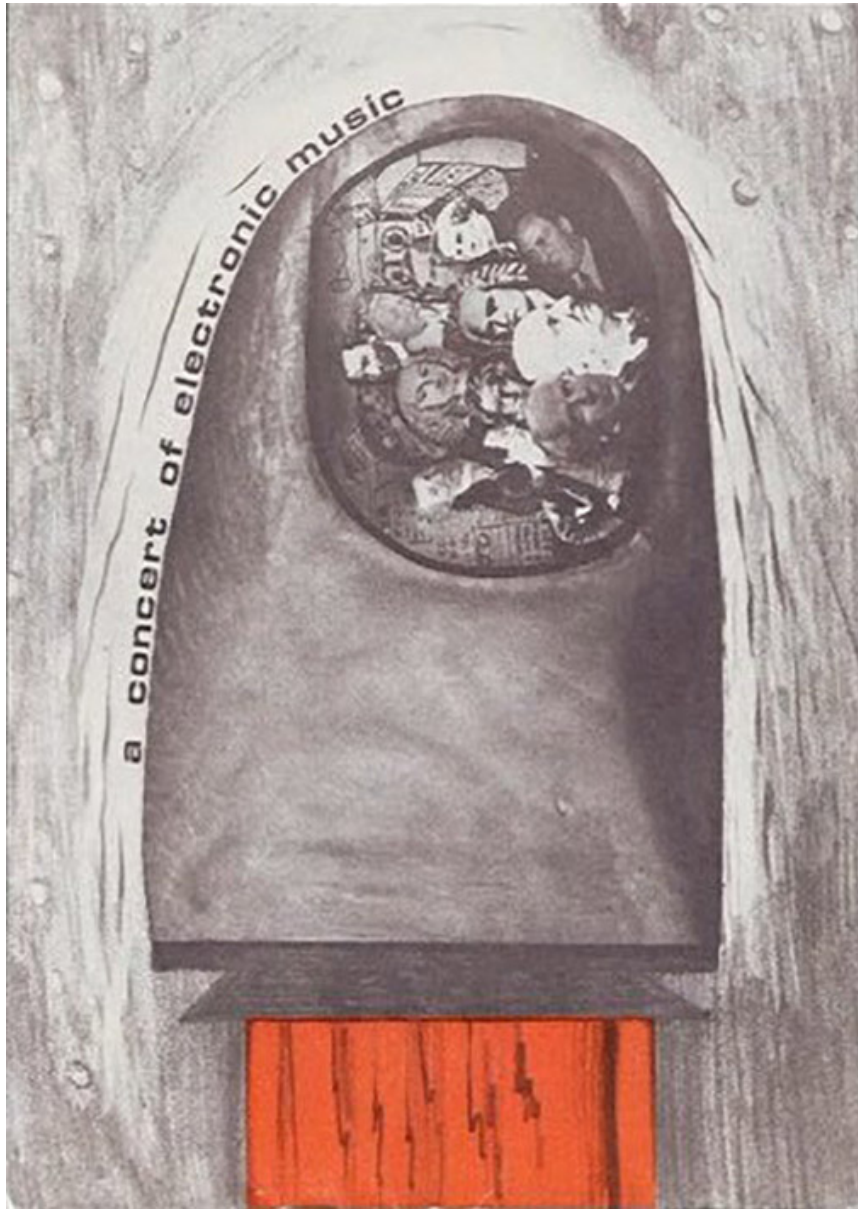

Chapter 3: Composing with computers, 1969–70

3.1 Introduction

In the preceding chapter, we saw how the computer became central to the story of EMS, presented as a technological spectacle in the Concert of Electronic Music and at the Cybernetic Serendipity exhibition, used as a compositional tool for Peter Zinovieff and Alan Sutcliffe, and, more generally, beginning to be understood as a new medium for making art. It also became a selling point for Zinovieff's studio facilities, which, by 1969, he and his colleagues were advertising as 'the most advanced in Europe'. For composers, an organisation now called Electronic Music Studios offered consultancy and assistance, stating that, 'from initial composition through realisation to final performance advice and equipment is available'.¹ As we saw in Chapter Two, the advert from which the preceding text is taken appeared on the outside back cover of the programme for Event One, the Computer Arts Society's launch event, ensuring that it would be seen by numerous artists, designers and others interested in the possibilities of computer-controlled sound and music.

The claims made in the Event One advert were ambitious but not exaggerated. Peter Zinovieff's studio was expanding. In addition to the PDP-8/S minicomputer that had been purchased in 1967, a PDP-8/L was added to the system that he had been assembling with engineer David Cockerell. As Zinovieff wrote in July 1969, the studio was 'only just finished, if studios can ever be finished';² but it had reached a state in which he felt confident enough to invite composers to use it, and to employ a small number of staff to assist him. The studio would soon no longer be situated in the garden shed, but in the spacious ground floor of 49–51 Deodar Road, Zinovieff having bought the house next door and combined the two properties. Its networked system of two computers, analogue-to-digital and digital-to-analogue converters and various analogue sound making and recording devices began to be known as MUSYS, short for Music System, and will be referred to as such in this chapter.³

¹ *Event One* (London: Computer Arts Society, 1969), p. 13.

² Peter Zinovieff, 'The Special Case of Inspirational Computer Music Scores', *The London Magazine*, 4, 9 (1969), 165–176 (p. 169).

³ MUSYS is also the name of the software written to be used with this system, however it is hoped that the context will make clear which of these I am referring to.

A relatively small amount of music produced using MUSYS survives today, but this body of work includes works by important composers, namely Harrison Birtwistle – who, as we saw in Chapter One, was a close friend and colleague of Zinovieff’s – and Hans Werner Henze, who commissioned Zinovieff to create the electronic elements of his orchestral work *Tristan* in 1972.⁴ A great deal of literature on Birtwistle’s work exists elsewhere,⁵ so with this in mind I provide only brief accounts of two of Birtwistle’s compositions in this chapter.

Instead, I give an account of the early development of Zinovieff’s studio in the context of other computer music facilities that were being set up at the same time. I outline the important features of MUSYS and its software, drawing on interviews with the programmer Peter Grogono. With reference to two compositions by Harrison Birtwistle, I ask what was understood by the idea of ‘composing with a computer’ in the early 1970s, both practically and more conceptually. I examine concerns from within the field of electronic music about computer music in the late 1960s through a reading of the BBC film *The Same Trade as Mozart*,⁶ and use the setting of the 1970 UNESCO Conference on Art and Technology to outline an international context for the work taking place at EMS. I conclude by considering the challenges of writing cultural histories of technological innovation.

3.2 The hybrid studio

The two PDP-8 computers formed the basis of MUSYS, each responsible for running programs specific to different aspects of the composition and realisation processes. In 1969 Zinovieff hired Peter Grogono, a programmer with an interest in electronic music, to develop a computer language for users of MUSYS. Working alongside Zinovieff, Grogono wrote a series of programs with which composers could input series of musical instructions, using this new language, on the PDP-8/L via a teletype

⁴ Hans Werner Henze, *Tristan* (1973). See Stephen Downes, *Hans Werner Henze: Tristan (1973)*. (Aldershot: Ashgate, 2011); and Hans Werner Henze, *Bohemian Fifths: An Autobiography*. Translated from German by S. Spencer (London: Faber & Faber, 1998).

⁵ See Robert Adlington, *The Music of Harrison Birtwistle* (Cambridge: Cambridge University Press, 2006); David Beard, *Harrison Birtwistle’s Operas and Music Theatre* (Cambridge: Cambridge University Press, 2012); Jonathan Cross, *Harrison Birtwistle: Man, Mind, Music* (London: Faber & Faber, 2000); and Tom Hall, ‘Before *The Mask*: Birtwistle’s electronic music collaborations with Peter Zinovieff’, in *Harrison Birtwistle Studies*, ed. by D. Beard, K. Gloag, and N. Jones (Cambridge: Cambridge University Press, 2015).

⁶ *The Same Trade as Mozart* (dir. Buckton, 1969).

machine; these instructions would then be compiled into data and read by a 'performance program' running on the PDP-8/S, which would send the data to a number of digitally controlled analogue oscillators, filters and amplifiers, via digital to-analogue-converters (DACs). In this way the composer's score was both read and 'performed' by the computers and analogue devices in the studio.

A set-up of digitally controlled analogue devices like this is known as hybrid synthesis, combining digital and analogue technologies in a way that uses the best aspects of both: the speed and flexibility of analogue processes, combined with the accuracy and repeatability of digital.⁷ In 1969 digital synthesis of sounds required a higher level of processing power than was currently available to most studios, as well as particularly skilled use of the computer to maximise its potential;⁸ it demanded so many resources that conducting any kinds of experiments with live synthesis was virtually impossible.⁹ A hybrid system could make use of voltage-controlled analogue devices that a studio might have already amassed, such as oscillators (VCOs), amplifiers (VCAs), harmonic generators, filters (VCFs), mixers, tape recorders and modifying devices such as ring modulators, connected with DACs, which by 1969 were fairly easy to buy or build, and which converted digital information into voltages.¹⁰ The small memory of a minicomputer such as the PDP-8 would be less of a disadvantage when used with DACs and an external disk unit for storage of programs and control information.

From the mid-1960s, a small number of electronic music studios experimented with combining digital and analogue technologies. The PIPER system, set up in 1965 by James Gabura and Gustav Ciamaga at the University of Toronto Electronic Music Studio (UTEMS), used an IBM0-6120 and Moog oscillators, in one of the earliest examples of this kind of system; and there were experiments in hybrid methods such as Joel Chadabe's Coordinated Electronic Music Studio System (CEMS) at SUNY

⁷ A similar principle can be seen in the hybrid digital-analogue computers manufactured from the early 1960s to around 1970 by Electronic Associates, Inc and Packard Bell, among others. See James S. Small, *The Analogue Alternative: The Electronic Analogue Computer in Britain and the USA, 1930-1975* (London: Routledge, 2001), p. 153-163.

⁸ Max Mathews, Joan E. Miller, John E., Moore, F. R. Pierce, Jean-Claude Risset, *The Technology of Computer Music* (Cambridge, Mass: MIT Press, 1969), p. 6.

⁹ Peter Manning, *Electronic and Computer Music*, 4th edn (Oxford: Oxford University Press, 2013), p. 233; Paul Doornbusch, 'Early Hardware and Early Ideas in Computer Music – their Development and their Current Forms', in *The Oxford Handbook of Computer Music*, ed. by R. Dean (Oxford: Oxford University Press, 2009), p. 59.

¹⁰ Mathews et al., p. 26; John E. Rogers, 'The Uses of Digital Computers in Electronic Music Generation', in *The Development and Practice of Electronic Music*, ed. by J. H. Appleton and R. C. Perera (Englewood Cliffs, NJ: Prentice-Hall, 1975), p. 118.

Albany, which used a digital clock and mixer as part of a specially built Moog system.¹¹

EMS's closest relation was GROOVE, a hybrid system developed at Bell Labs, New Jersey by Max Mathews and Richard Moore and first demonstrated in 1970. Mathews had been experimenting with digital synthesis and computer languages for music some years, having written MUSIC I, the first music programming language, in 1958;¹² for this new project, MUSIC, now MUSIC V, was used to program compositions to be realised on voltage-controlled synthesizers. Like MUSYS, GROOVE (which stood for Generating Real-time Operations On Voltage-controlled Equipment) was designed to be musician-friendly and fairly intuitive to use. It consisted of a similar set-up of minicomputer – in this case a Honeywell DDP-224 – along with storage disks, converters and various analogue sound devices and its main design principle of dividing composition and performance tasks between digital control and analogue sound synthesis was fundamentally the same. The two systems had some significant differences, one being that GROOVE was designed with more of a composer/performer in mind, increasingly so as it attracted users who had previously worked with modular synthesizers such as the Buchla 100 series and who found in GROOVE what composer and programmer Laurie Spiegel, who worked with the GROOVE system in the mid-1970s, has called a shared 'concept space'.¹³ Here the realization of a pre-written score was of less importance than the generation and manipulation of sound as a material in real time. Rather than beginning with a score that would then become the source program for a composition, a user of GROOVE could start the composition process in a more improvisatory way by playing with a set of analogue modules, the settings and parameters of which could then be stored by the computer, or program some aspects of the piece while still controlling, for example, the timbre, speed or other parameters by hand.¹⁴

EMS was the first studio in Europe to use a hybrid set-up of minicomputers plus analogue sound devices, and, as Manning writes, 'the most attractive computer facility available anywhere, certainly one of the cheapest in terms of capital costs'.¹⁵ That

¹¹ Doornbusch, p. 60.

¹² Thom Holmes, *Electronic and Experimental Music: Technology, Music, and Culture*. (Routledge: New York/Abingdon, 2016), p. 362.

¹³ Laurie Spiegel, 'Graphical GROOVE: Memorial for the VAMPIRE, a Visual Music System', *Organised Sound*, 3: 3 (1998), 187-191 (p. 188).

¹⁴ Holmes, p. 409.

¹⁵ Manning, pp. 236-7.

these costs were so low – and it should be noted that they were, in relative terms, still very high compared to running an all-analogue studio – was due in part to the availability of the PDP (portable data processor) range of minicomputers. These were launched by the Digital Electronic Corporation (DEC) in 1965, and would be used in a number of electronic music studios, including Knut Wiggen’s Elektronmusikstudion (EMS) in Stockholm and the Utrecht-based Institute of Sonology, run by Gottfried Michael Koenig, both of which purchased the more advanced PDP-15 in 1970-71.¹⁶ Despite its limitations of memory and power, the PDP-8 was an ideal computer for use in a range of different settings: it was small enough to be incorporated into a laboratory or office – or indeed a music studio – without the need for a special power supply or controlled climate; it was also faster and far cheaper than other available computers.¹⁷ These practical considerations were both responsive to and prescient of a changing relationship to computer technology, as Ceruzzi notes:

At the highest level, DEC had initiated a social innovation as significant as the technology. DEC was a small company and did not have the means to develop specific applications for its customers as IBM’s sales force was famous for doing. Instead it encouraged the customers themselves to develop the specialized systems of hardware and software. It shared the details of the PDP-8’s design and operating characteristics and worked with customers to embed the machines into controllers for factory automation, telephone switching, biomedical instrumentation and other uses: a restatement in practical terms of the general-purpose nature of the computer as Turing had outlined in 1936.¹⁸

To think about the practical difference the PDP-8 represented, we should remember that the Honeywell DDP-224 used at Bell Labs, although more powerful, was so big that it was housed in its own room with the analogue equipment in another: Laurie Spiegel recalls they were separated by a long corridor. This image of the composer-programmer – as Spiegel was – walking between rooms creates a striking visual

¹⁶ Sanne Krogh Groth, *Politics and Aesthetics in Electronic Music: A Study of EMS – Elektronmusikstudion Stockholm, 1964-79* (Heidelberg: Kehrer, 2014), p. 157; Stan Tempelaars and G.M. Koenig, ‘The Computer at the Institute of Sonology, Utrecht’, *Interface* 1 (1972), 167–174 (p. 167).

¹⁷ Paul Ceruzzi, *A History Of Modern Computing* (Cambridge, Mass: MIT Press, 2003), p. 129.

¹⁸ *Ibid*, p. 135.

analogy with ideas of input and output, or indeed analogue and digital processes, and reminds us that the ‘real-time’ aspect of GROOVE referred to its control possibilities, but not necessarily the physical experience of using it.¹⁹ At EMS’s Putney headquarters, the entire system was able to fit into the living room of a house. This bringing together of previously discrete spaces also brought the relationships between and definitions of device, composer, technician, programmer and performer closer together, as well as prefiguring the mixed analogue-digital synthesizers of the later 1970s and 1980s, and analogue-modelling digital synthesizers developed in the 2000s.

In *Technics and Time 1: The Fault of Epimetheus*, the philosopher of technology Bernard Stiegler describes the process of technical evolution in which technical tendencies become part of technical ensembles, which are composed of techniques and individuals: to use an example from this study, we might view an electronic musical instrument, such as a synthesizer, which develops from the technique of voltage control, as an ensemble. These iterations of hybrid synthesis systems – from Bell Labs to EMS – might be viewed in a similar way, as evolving ensembles within which are contained a fairly stable set of techniques.²⁰ The hybrid digital-analogue studio was perceived at the time as a flexible, interstitial technology. A description of a hybrid studio – using EMS as an ideal example – written by Tristram Cary demonstrates how it could be seen as having evolved from an existing ‘simpler’ one, and would go on to develop in the future: ‘Beginning with some VC [voltage controlled] equipment, the studio can grow until it justifies interfacing the VC equipment with a computer,’ Cary assured the readers of *Hi-Fi News’s Audio Annual*. ‘The computer, too, is expandable – more storage, more variety of inputs and outputs.’²¹

In the case of EMS, this possibility for growth was accelerated by Zinovieff’s close working relationship with designer and engineer David Cockerell. Cockerell

¹⁹ Spiegel writes, ‘In general, there were a lot of interconnections between the digital and analog domains and we played with them quite a bit. This was often difficult because the analog audio lab and the digital computer hardware were in separate labs at a cumbersome distance from each other, connected by several hundred yards of trunk cables. We all made many trips back and forth between the analog and digital ends of GROOVE to calibrate DAC output voltages or to change the configuration of the multicolored spaghetti. (A typical patch consisted of hundreds of cables on a removable patch matrix board that each user could slide into a card rack full of audio modules too miscellaneous to describe here, so that each user could pursue a hardware configuration unlike anyone else’s).’ Spiegel, ‘Graphical GROOVE’, p. 187.

²⁰ Bernard Stiegler, *Technics and Time, 1: The Fault of Epimetheus*, translated from French by S. Barker (2000), (Stanford: Stanford University Press, 1994), pp. 51–53 and 66–67.

²¹ Tristram Cary, ‘Electronic Music – Background to a Developing Art’, *Audio Annual 1971* (pub. *Hi-Fi News*, 1971), 42–49 (p. 46).

built the devices necessary for the various parts of the system to communicate with one another, which included not only DACs but also, for example, a device to enable the two computers to interact.²² By 1969 he had been working with Zinovieff for around three years, so in many ways, MUSYS was a natural expansion of the studio that they had been piecing together since the mid-1960s.

Cockerell's proximity to the studio and close working relationship with Zinovieff meant that he was able to respond quickly to requests for new or altered hardware and deliver custom equipment often with a very fast turnaround. As Zinovieff has remarked, the independence of EMS from any larger organisation meant that new hardware ideas could be tested and followed through quickly without having to go through the various levels of management that one might have to at a large institution such as Bell Labs or a broadcasting studio: 'Whereas I was able to say to David [Cockerell], "go and buy whatever you want and make it"'.²³

The environment at EMS presented a set of conditions to which the hybrid synthesis model was especially suited. This model allowed the studio to combine and make the most of its resources, and made good use of the expertise of a small team that worked closely with one another and came up with fast solutions to problems. This was particularly useful for dealing with the constant revisions, technical fixes and debugging needed in operating such a system. As mentioned above, the high quality and specificity of EMS's hardware, as engineered by Cockerell, was also a significant factor here. Another integral part of the hybrid system was the programming language written by Peter Zinovieff and Peter Grogono.

3.3 A computer language for electronic music

When Peter Grogono arrived at EMS, he noted that, 'The software at EMS at that time was extremely primitive: composers were expected either to compute long sequences of numbers (or, even more tediously, write them out explicitly) that were converted to sounds'.²⁴

²² Peter Grogono, *Ricordanza* (unpublished manuscript, 1985), p. 23.

²³ James Gardner, 'Interview – Peter Zinovieff', supplementary interview to *These Hopeful Machines* series (Radio New Zealand, 2013)

<http://www.radionz.co.nz/concert/programmes/hopefulmachines/audio/201812332/interview-peter-zinovieff>

²⁴ Peter Grogono, interview with author, 2016.

He began trying to write a digital synthesis program for the new PDP-8/L; it was then decided to use both computers in the way described earlier in the chapter, with Zinovieff writing the code for the two PDP8s to communicate with one another. In September 1969 Grogono was given a six-month contract via a simple letter stipulating that his role at EMS would be ‘to make Musys a fantastically sophisticated software package’.²⁵ A 1973 paper by Grogono sets out what that meant in practice – the development of a series of programs in which:

- (1) Common features of musical composition are expressed in simple ways;
- (2) The language is easy to learn and use by composers;
- (3) The compiler is efficient, so that a composition can be developed interactively;
- (4) The whole system, including files of data, fits on the disk, so that paper tape is not necessary during normal use.²⁶

It was not expected that a composer would easily understand how to program an entire complex score on their own, more that they would be able to learn the language and understand the possibilities and limits of the system well enough to work with a programmer to realise an existing score or an adaptation of one, or devise a new work. However, it was feasible that a composer with no experience of programming would be able to grasp how to write a simple program to produce, for example, a series of pitches from an oscillator to be treated with a filter, using device codes such as O1 (oscillator 1) F2 (filter 2), and so on, and setting the duration, volume, and other parameters of notes. In addition, the concept of encoding notes in a melody and its accompaniment into numbers related to chromatic scales would not be unfamiliar to composers who had composed serial music using tone rows, or studied musical analysis; and as Grogono confirms, operations such as transposition and inversion, which are commonly used in serial music, ‘were easily computed’.²⁷ As with previous experiments with computer music such as those by Lejaren Hiller and Stanley Gill

²⁵ Peter Zinovieff to Peter Grogono, 1969. Spelling of ‘Musys’ as shown in original.

²⁶ Peter Grogono 1973, ‘MUSYS: Software for an Electronic Music Studio’, *Software: Practice and Experience* 3: 4 (1973), 369–383 (p. 370).

²⁷ Peter Grogono, interview with author, 2016.

(described in Chapter Two), knowledge of twelve-tone serialism proved to be a useful grounding for programming a composition.

However, the compositions realised at EMS that have survived demonstrate a more varied approach than this description implies. Composers such as Harrison Birtwistle integrated electronic sounds into works written for and performed by acoustic instruments, or, in the case of the fully electronic *Chronometer*,²⁸ made use of the studio's ability to analyse, transform and organize concrete sounds in new ways. Rather than producing entire works, MUSYS was more frequently used for creating elements, component parts of what one could call hybrid electronic-acoustic works.

As I have noted earlier, the name MUSYS was used – and still is by those who worked at EMS – to refer both to the programming language and to the system which used it; while Zinovieff, in response to my questions about Grogono's original program, expanded the term further, saying that,

I always thought of MUSYS as the studio ... whether it was me collecting things together or the advanced FORTRAN programs that Alan [Sutcliffe] was writing,²⁹ and I see it as 'what went on at Putney', rather than a specific program.³⁰

To frame the software as discrete from the hardware of MUSYS does not take into account the status of software at this time, much of which was idiosyncratic and system-dependent, indelibly tied to, or at least constantly reminding the user of, the hardware that they were using.³¹ Grogono notes that he and Cockerell frequently debated the assignation of tasks to the computer or to the other devices in the studio: Cockerell was in favour of less hardware, but Grogono argued that, because PDP-8 computers had such limited memory, the more tasks that could be assigned to the devices, the better.³² Although Grogono had been engaged as a programmer, Zinovieff remained responsible for much of the coding, particularly that which facilitated communication between devices.³³ The closeness of all these technological and

²⁸ Harrison Birtwistle, *Chronometer* (1971).

²⁹ This refers to Sutcliffe's work as a programmer at EMS in the mid to late 1970s; see also Peter Zinovieff, 'From a Diary: Electronic Music', in *PAGE 38* (1977), p. 2–5.

³⁰ Peter Zinovieff, interview with author, 2016.

³¹ Ceruzzi reminds us that it was only in 1968 that IBM began to sell software separately from computers themselves; and this commercial move did not affect small companies like EMS working with specialist areas such as music. Ceruzzi, p. 101.

³² Grogono, *Ricordanza*, p. 8.

³³ Peter Zinovieff, interview with author, 2016.

working relationships is perhaps demonstrated in Grogono's recollection of how, when Harrison Birtwistle was using the studio for a concentrated period of time, 'I could get called in the middle of the night to rewrite a program for the following morning to a new specification'.³⁴

3.4 Hybrid practices: collaborating with composers

In documenting the development of MUSYS we should also consider the contributions of the composers who used EMS. When composers started coming to the studio, Grogono recalls that their questions and thoughts on his software prompted him to make changes to it, remarking that, 'people want to use [your software] in unanticipated ways'.³⁵

By 1970, it was decided that the latest iteration of the MUSYS software, which Grogono called MUSYS 3, worked well enough to be tried out by a group of composers. The Arts Council provided funding for 13 composers to undertake a week-long course in using the studio, organized under the auspices of the newly-formed British Society for Electronic Music (BSEM), which included Peter Zinovieff and Harrison Birtwistle as founders (see Chapter Two). Course participants included David Lumsdaine and Jonathan Harvey; early EMS associate Don Banks; Annea (then known as Anna) Lockwood, who worked across electronic music and Fluxus-influenced sound art often in collaboration with Hugh Davies; and Keith Winter, who was at the time a Music Officer for the Arts Council.³⁶ Composers were asked to bring an existing score or a sketch for a new composition, which would then be discussed with Zinovieff and Grogono before attempting to realise the piece using MUSYS. Grogono observed that most composers, in order to do this, broke their scores into small units for which a program could be written; a longer program could then be compiled from these units.³⁷ Summing up the course, Grogono reflects:

I don't think anyone achieved the piece they had planned. Some got quite close, others got nowhere. Most seemed to feel that the experience was interesting and useful, even if they didn't come away with a good composition. One or two

³⁴ Grogono, *Ricordanza*, p.6. Grogono lived at the time at 53 Deodar Road.

³⁵ Peter Grogono, interview with author, 2016.

³⁶ Manning, p. 239; Arts Council, p. 83.

³⁷ Grogono, 'MUSYS: Software for an Electronic Music Studio', p. 382.

were a bit sceptical, and found the week to be a waste of time.³⁸

Annea Lockwood recalls,

I had not worked with a computer at all, but wanted to try it, to get some basic grasp of what programming enabled at that time. ... But the laborious and initially fairly abstract nature of the process of sound generation possible there turned out to be too far removed from my ways of thinking and working with sound, and I did not follow up and probe further than the course.³⁹

However, Lockwood and Grogono developed a friendship and working relationship as a result of the course, with Lockwood mixing her 1970 composition *Tiger Balm* at EMS.

Lockwood was among several composers on the course who had previous experience of making electronic music. In the mid-1960s, she had studied with Gottfried Michael Koenig in Cologne and Bilthoven, The Netherlands. Jonathan Harvey had previously worked with computers at Princeton University and, according to Zinovieff, came to EMS with ‘very, very complicated things he wanted to do,’ which were not always possible to execute.⁴⁰ Those composers who were versed in serial techniques and certain kinds of musical analysis were more easily able to translate their structural ideas into programs, as were those who wanted to compose using a standard system of chromatic scales. As Grogono comments,

Composers who wanted thick, layered sounds without tonal structure were out of luck. We did manage that later, to some extent, but not in time for the course ... The composers we found hardest to deal with were those with very abstract ideas that did not easily relate to concrete sounds (computers are very concrete!). I cannot recall specific examples, but this sort of request went along the lines of “relaxed and slow at the beginning, building slowly to a pulsating climax with low, throbbing sounds, then returning quickly to the opening quietness, giving the feeling of a brush with unexpected danger and a return to safety.”⁴¹

³⁸ Peter Grogono, interview with author, 2016.

³⁹ Annea Lockwood, correspondence with author, 2018.

⁴⁰ Gardner, ‘Interview – Peter Zinovieff’.

⁴¹ Peter Grogono, interview with author, 2016.

Here, Grogono touches upon an important issue: that of the vocabulary required for a composer to work fruitfully with a computer. This was a concern shared by a number of composers and theorists, including Zinovieff, EMS Stockholm's Knut Wiggen⁴² and Pierre Schaeffer, whose development of a linguistics-based typology of sounds was complicated by the use of computer-generated sounds in composition, which signified, for him, a move away from listening-focused composition to reductive methods based on random generation and selection of musical data.⁴³ The issue here could be seen as one of translation, and not only of numerical data into musical structures, if the computer was to be seen not purely as a device for aiding calculation but one which could inspire new musical expression.

In practical terms, the sonic, rather than purely musical, questions that were most successfully asked of the studio by composers were those that demonstrated enough of an understanding of technology to know what the computer and its operators might or might not be able to do. Grogono notes, and his observation is borne out by a number of writers, that Harrison Birtwistle – who did not attend the course, but was already an associate of Zinovieff's and had, like Jonathan Harvey, gained some experience of electronic music through a fellowship at Princeton⁴⁴ – used the studio most effectively because he understood how his sonic and musical concepts related to the studio's actual capabilities, and was able to express his ideas in terms that were highly descriptive yet precise. Grogono remarks,

He would come with requests for very specific sounds (“a series of low notes with bell-like overtones with gradually increasing tempo”). We would create the sounds as best we could, and [Birtwistle] would listen and ask for changes (“a fifth lower and slightly faster”). This approach was much easier for us than requests for vague moods (“sad but lyrical”).⁴⁵

As Tom Hall and Peter Zinovieff have both reiterated,⁴⁶ the composer in this case did not attempt to operate the computer or any of the other equipment in the studio. On the

⁴² Groth, 2014, p. 128.

⁴³ Pierre Schaeffer in UNESCO, *Music and Technology: Prepared for UNESCO on the basis of the papers and reports of the Meeting on Music and Technology, organized by UNESCO in Stockholm, Sweden, in June 1970* (Paris: La Revue Musicale, 1971), pp. 58–65.

⁴⁴ Hall, p. 64.

⁴⁵ Peter Grogono, interview with author, 2016.

⁴⁶ Hall, *Before the Mask*; Peter Zinovieff, 'Compositional Attitudes to Electronic Music', *Composer* (Magazine of the British Music Information Centre) 76/77 (1982), p. 8.

other hand, neither did Birtwistle bring a finished score or set of instructions to EMS to be turned into electronic music in his absence; he often remained present at the studio, revising ideas as he went along and forging a close relationship with Zinovieff such that Zinovieff was able to translate the composer's structural ideas, often at an early stage, into electronic sound with a high degree of accuracy, as Zinovieff explains, 'I would put my interpretation of his score into sounds, and he would say yes or no – and he would always say yes, actually, because I was good at interpreting what these sort of things meant'.⁴⁷

The term 'interpretation', as used above, is often synonymous with performance of a musical piece – as in the player's 'interpretation' of a composer's score – but to see what Zinovieff was doing with Birtwistle in similar terms would be to consider the electronic music studio as an instrument and Zinovieff as an instrumentalist, rather than understanding the studio as a system consisting of potential instruments waiting to be created and activated by its multiple users.⁴⁸ Perhaps this is why the term 'realisation', used by the BBC Radiophonic Workshop to distinguish between the soundtrack composer's role and that of the electronic studio operators,⁴⁹ became more common for the kind of work Zinovieff was doing with Birtwistle. This term, analogous with neither performance nor production exactly, but suggestive of both, casts the studio and its workers as not only essential – in that the work requires their contribution in order to exist – but also creative, in the way that it echoes the French term for a director, 'réalisateur', often used to describe a director of film.

The complex set of mediations between the composer's idea and the resulting music produced by the computer, its networked devices, and the multiple people using them, requires us to look beyond the traditional relationships that are assumed between performer and instrument, conductor and instrumentalists, and composer and performer, and notice these resonances from other fields such as cinema, broadcasting and popular music, as well as looking towards the collaborative practices that became possible in this period of studio-based electronic music. As I remarked in Chapter One, there are an increasing number of perspectives on collaboration in electronic music which take into account the roles not only of programmers or performance technicians but also scientists, computer companies and the non-human actors

⁴⁷ Peter Zinovieff, interview with author, 2016.

⁴⁸ see Douglas Kieslar, 'A Historical View of Computer Music Technology'. In *The Oxford Handbook of Computer Music*, ed. by R. Dean (Oxford: Oxford University Press), p. 20.

⁴⁹ Niebur, *Special Sound*, p. 96.

represented by the equipment itself. For the purposes of this section, I want to focus on the most immediately apparent manifestation of collaboration, between the composer and the producer/realiser of electronic sounds as described above, as well as introducing the idea that the composer collaborates with the studio not just materially in their use of its equipment, but in their inhabiting of and furnishing it as an imaginative space.

3.4.1 *Chronometer*: questions of authorship

In his paper ‘Before The Mask: Birtwistle’s electronic music collaborations with Peter Zinovieff’, Tom Hall proposes that not only *Chronometer* but a number of other works can be regarded as co-authored compositions, displaying convincing evidence that Zinovieff’s aesthetic as well as technical contribution to Birtwistle’s work should be recognised as laying the groundwork for ‘notative microcosms of compositional approaches that Birtwistle developed further elsewhere’.⁵⁰ However, *Chronometer*, one of Birtwistle’s only completely electronic works, illustrates the collaborative nature of their relationship most clearly.

Hall draws attention to the two men’s shared interest in mechanical operations, grammatical systems, the measurement and experience of time,⁵¹ and the use of random processes to create new musical material, all areas which have an obvious affinity with computing, and which enabled Birtwistle to approach the studio with an instinct for the as-yet-undefined language with which to talk ‘to’ it; if not the language of programming itself, the meta-language of parameters, commands and directions that could be used to describe what a program is or does. For *Chronometer*, these concerns became subject matter, as Birtwistle and Zinovieff made recordings of numerous clocks and metronomes, including the chimes of Big Ben. These sounds were analysed, transformed and then recomposed using MUSYS, in a process similar to Zinovieff’s later experiments with speech synthesis, resulting in what Jonathan Cross calls, ‘computer-based musique concrète’.⁵² While the production of the synthesized sounds was carried out by Zinovieff, the piece’s structure followed a graphic schema drawn up by Birtwistle, which no longer survives although it is

⁵⁰ Hall, p. 63

⁵¹ See Adlington (2006, pp. 99–100) for a useful account of Birtwistle’s approach to time in *Chronometer* and the instrumental work *The Triumph of Time* (1971).

⁵² Cross, *Harrison Birtwistle*, p. 182.

remembered by both Zinovieff and Birtwistle as a large graphic score comprising several large pieces of paper Sellotaped together.⁵³

A fragment of this score is reproduced in the liner notes of the first record release of *Chronometer*.⁵⁴ The LP states Birtwistle clearly as the composer and therefore the author of the work. Yet Zinovieff provided detailed notes for the recording as well as for the piece's live premiere in 1972, for which he and Birtwistle devised a kind of code-like vocabulary for the sounds used in the piece. The purpose of these notes was to inform the reader of the technological process of making the piece, rather than to claim authorship of it, and indeed Zinovieff, in an article outlining the different ways in which composers had used his studio, claimed that in this case, 'every step... was truly Birtwistle's own'.⁵⁵ However, Hall concludes of the 1975 record,

Although the *Chronometer* credits suggest a clear division of labour between the two men (composer and 'realizer'), the evidence points instead to a degree of overlap between the roles... Furthermore, the overall sound exemplifies the characteristic 'EMS sound' that results from the constraints and affordances available to Zinovieff when constructing his studio.⁵⁶

Hall's investigation into Zinovieff's input into *Chronometer* sheds light on Birtwistle's later compositions. In the context of this chapter, it also tells us about the correspondences and differences between how a piece of music is made and how its makers explain its genesis within the conventions of music publishing and recording. These conventions are challenged by various aspects of electronic music's conditions of creation, including this issue of collaborative or multiple authorship.

3.4.2 *Medusa*: questions of transformation

Before *Chronometer*, Birtwistle and Zinovieff had previously used MUSYS, in its very early stages, to create electronic elements for a piece called *Medusa*, first performed at Sheffield University in October 1969 and then revised in 1970. This revised, longer version was performed at the Queen Elizabeth Hall in March 1970 and

⁵³ Hall, *Before the Mask*; Peter Zinovieff, 'Compositional Attitudes to Electronic Music'; Peter Zinovieff, interview with author, 2016.

⁵⁴ Harrison Birtwistle, *The Triumph Of Time/Chronometer* (Argo, 1975)

⁵⁵ Peter Zinovieff, 'Compositional Attitudes to Electronic Music'.

⁵⁶ Hall, p. 78.

broadcast on BBC Radio several times during the 1970s.⁵⁷ The score has now been withdrawn from publication by Birtwistle, but recordings of both versions are accessible in the British Library's Sound Archives: like *Chronometer*, it now exists primarily as a recorded artefact. Birtwistle is said to have 'disowned' both versions of the score.⁵⁸

Jonathan Cross writes that this work was inspired by a reading of the biologist D'Arcy Wentworth Thompson's *On Growth and Form*, a 1917 book about mathematical forms found in nature. The title refers then not only to the Greek myth of Medusa, but also the name of the subphylum to which jellyfish belong. Birtwistle's programme notes for the 1970 concert refer to the jellyfish's method of reproduction in which parts of the animal detach and grow into new ones; in a similar way, the piece is composed of,

material which is either detached and allowed to develop independently, or fixed within its own defined area. All details, large and small, are related to the basic modular shape.⁵⁹

In the 1970 performance, some instruments were amplified electronically, while the piece's electronic elements, which were played on tape, consisted of a recording of a processed saxophone and a passage of complex synthesised sounds, generated using MUSYS, described by Peter Grogono as 'bursts of richly textured staccato chords, starting very rapidly and then slowing down'.⁶⁰ Around three minutes long, this passage takes as its starting point a Bach chorale, rendered as a program and then transformed in a similar way to that in which Grogono and Zinovieff experimented with computer generated 'variations' of classical works (producing, for example, 'A Lollipop for Papa', Zinovieff's computerised variations on a Haydn sonata). In 1972, Zinovieff would use MUSYS to analyse and transform elements of Wagner's *Tristan und Isolde* for Hans Werner Henze's *Tristan* (1973).⁶¹ In *Medusa*, melody, harmony

⁵⁷ H. Rees, 'Birtwistle's *Medusa*'. In *Tempo* 92 (Spring 1970), 28–31; Meirion Bowen, 'Variation Forms', *Music and Musicians* (February 1971), 34–36.

⁵⁸ Cross, *Harrison Birtwistle*, p. 123.

⁵⁹ Birtwistle quoted in Rees, p. 28.

⁶⁰ Grogono, *Ricordanza*, p. 10.

⁶¹ Henze's *Tristan* included three sections for tape, recorded before Henze orchestrated the work and therefore integral to its structure. As well as the Wagner material, Zinovieff and Henze recorded parts for percussion, prepared piano and a passage spoken by Zinovieff's

and rhythm are transformed, rendering pitches almost unrecognisable (an effect which is echoed by the use of semi-tuned percussion, such as crotales, elsewhere in the piece). The passage forms a dense, energetic cluster at the centre of the piece, focusing the attention on the complex rhythms generated by material. Yet it was this element, with its treatment as a ‘found object’ among other ‘found’ musical material,⁶² that Birtwistle, in retrospect, did not want to preserve, declaring that, ‘There’s nothing in [*Medusa*] which has the right to be placed next to a Bach chorale, least of all to be transformed into it’.⁶³

It is not my intention to try to critically rehabilitate this work or disregard those elements which Birtwistle went on to find problematic. However, I want to suggest that it is possible to listen to *Medusa* on its sonic merits, understanding it as an early example of how electronic elements created through hybrid digital-analogue synthesis can be successfully integrated into a composition for an instrumental ensemble, playing an important part in ‘weaving together this already highly integrated material’⁶⁴ and mirroring, in the transformation of the Bach material by the computer and the transformation of sounds by effects such as distortion and ring modulation, the transformational methods used in the composition, such as palindromic patterns or re-composed parts from other works. Timbrally, the instrumental and electronic elements often draw the listener’s attention to the more unusual sonic qualities of the acoustic instruments in a way that challenges the distinction between what is heard and categorised as ‘electronic’ or ‘acoustic’ sound. In this sense, the collaboration between composer and studio also has a conceptual aspect, as both the composition’s sound-world and its mathematical-scientific inspiration raise questions of how we understand and recognise images and sounds as ‘natural’ or ‘artificial’.

My accounts of these compositions give a brief illustration of how collaboration between a composer and a studio can take various forms, ranging from shared working methods to factors which are harder to trace, such as reciprocal influencing and the sharing of extra-musical interests, and the creative input of the electronic ‘realiser’. It is possible to regard all studio-created electronic music as ‘a collaborative endeavour’,

son; a passage for Renaissance instruments was also recorded and processed at the studio. Evocative accounts of these sessions at EMS can be found in Henze, *Bohemian Fifths*, pp. 316–318.

⁶² Bowen, p. 36.

⁶³ Cross, *Harrison Birtwistle*, p. 123.

⁶⁴ Rees, p. 29.

as Parolini does in her study of Pietro Grossi's 1970s computer music,⁶⁵ whether the technology in that studio is what was referred to as 'classical' (which is to say, containing neither voltage-controlled nor digital equipment but just 'sound generators, modulators, storage and playback devices')⁶⁶ or the more advanced environment of EMS. Holding this idea in mind, the next section I want to shift the focus onto the presence of the computer as a collaborative actor in the studio: how it was perceived to enhance or diminish the role of the composer, and how it affected notions of the composer as an artistic individual. I am interested in the claims that were made for the computer's potential for both harm and good, as well as the analogies made for it by its proponents as they sought to explain to their peers, and to the public, why this new method of music-making was worthy of attention.

3.5 Developing a discourse of electronic music

Having described the early development of MUSYS, in this section I look at how the studio was portrayed by Zinovieff and others during its first years of operation, and reflect upon the language and discourse of electronic music as its users dealt with increasingly complex ideas and rapidly changing technology. In 1969, with his studio newly established, Zinovieff became something of an ambassador for computer-based music, speaking at the Institute of Sonology in Utrecht in 1968,⁶⁷ co-founding the British Society for Electronic Music in 1969, showcasing EMS's work at the launch of the Computer Arts Society (see Chapter Two), writing for print media and appearing on TV. As we have seen in the previous chapter, he also advocated, along with Tristram Cary and Harrison Birtwistle, for the establishment of a national electronic music facility in the UK, with EMS as its starting point.

3.5.1 EMS in the media

Writing in the 1990s about the evolution of electronic music, Laurie Spiegel proposed that each new development in music technology 'underwent a period of controversy in

⁶⁵ Guiditta Parolini, 'Music without Musicians...but with Scientists, Technicians and Computer Companies', *Organised Sound*, 22: 2 (2017), 286-296 (p. 286).

⁶⁶ Werner Kaegi in UNESCO, p. 22; Cary, 'Electronic Music – Background to a Developing Art', p. 46.

⁶⁷ Peter Zinovieff, 'A Computerized Electronic Music Studio', *Electronic Music Reports*, No. 1 (The Institute of Sonology at the University of Utrecht, 1969).

which it was commonly viewed by nonparticipants as almost diabolical (e.g., “dehumanizing”).’ This was then followed by a move towards commercialisation, which also brought with it exaggerated views of the technology’s capabilities, but this time with positive intent.⁶⁸

We encounter such claims of ‘dehumanization’ and counter-claims for enhanced human creative capacities in *The Same Trade as Mozart*, a film broadcast by the BBC in August 1969 as part of its *Workshop* series on music. Produced and directed by David Buckton, it introduced the viewer to electronic music using interviews with Karlheinz Stockhausen, Tristram Cary, Peter Zinovieff, BBC Radiophonic Workshop staff Desmond Briscoe, David Cain and John Baker, and the Workshop’s founder, Daphne Oram, who demonstrated her Oramics technique of optical sound synthesis. In the film, Oram voices an opinion about computer music that echoes Spiegel’s description of its critics. For Oram, music ‘should be a projection of a thought process in the mind of a human being’, and a computer that could generate ‘music by the yard’ from random numbers was at odds with this. Oram’s stance was not uncommon in critiques of computer-created music at this time, as one can surmise from texts written in the 1960s by composers including Gerald Strang, Herbert Brün and others to counter such concerns.⁶⁹ The concern about ‘yards’ of music, with its associations with factor production and the textile industry, suggests an anxiety that music, if composed using a computer, could take on the character of any other mass-produced item. These ways of describing electronic music remind us that, as Tara Rodgers and Jonathan Sterne write, ‘as much as technical cultures may be constituted by “expert” language [...] this language is also metaphoric and full of tacit understandings’.⁷⁰

The final section of *The Same Trade as Mozart* is devoted to the computer in music. Zinovieff, who is interviewed at some length, concedes that one might indeed end up with ‘endless hours of rather boring, grey computer music’ from a computer program. Yet computer-generated compositions are still as concerned with Oram’s ‘human thought’ as any other music because, although computers are becoming more

⁶⁸ Laurie Spiegel, ‘That Was Then – This Is Now’, *Computer Music Journal*, 20: 1 (1996), 42-45 (p. 43).

⁶⁹ See, for example Brün, ‘From Musical Ideas to Computers and Back’, in Lincoln, H. (ed) *The Computer and Music*. New York: Cornell University Press. Everett Helm also reports that during a discussion at the UNESCO Art & Technology Conference in 1970, Pierre Schaeffer raised concerns that the ‘composer in the electro-acoustical media can fabricate miles of music’. Helm in UNESCO, p. 196.

⁷⁰ Tara Rodgers and Jonathan Sterne, ‘The Poetics of Signal Processing’, *differences* 22 (2-3), 31-53 (p. 48).

sophisticated, he argues, ‘really, in the future, it’s how inspired people are going to be in using them, not what the computer can do.’ Zinovieff reiterates the importance of developing a sophisticated computer language that can express complex musical ideas, and the camera lingers on a few pages of program text which, he points out, is the end result of many hours’ writing and correcting – the obvious analogy, of course, is a complex notated score.

Zinovieff is seen on screen re-enacting the process of collaborating on a composition with Justin Connolly, a number of whose works were realised at EMS in the early 1970s.⁷¹ Although its name is not mentioned, the composition appears to be *M-Piriform*, a piece for violin, flute, soprano and electronics. This and another piece, *Obbligati*, were used by Zinovieff in his paper for the Institute of Sonology in Utrecht as examples of works ‘primarily concerned with the generation of patterns which can be used both for instrumental writing and electronic treatment of live performance.’⁷²

In the film, Connolly describes a collaborative composition process in which ‘the technical knowledge is more or less frequently divided between the two people, but each has a field of his own’. The instrumental forces are agreed on through discussion, as is the piece’s canon-like structure, which allows for repetitions and transformations of material that are particularly suitable for expressing as a computer program, and both Connolly and Zinovieff are seen with scores, one traditional, one graphic. When Zinovieff explains the kinds of sounds that are represented by the graphic score, he counters the claim that computers produce merely hours or yards of music: the qualities that they produce beyond normal human capabilities are those of depth, precision and complexity. It is not a case of there being so much ‘of’ it, but so much *in* it. He states,

It would be inconceivable to tackle any part of [the score] by a classical method, because the amount of calculation to realise this really is gigantic, and the amount of information actually given out, even to the bits of apparatus, is probably several thousand per second, and one just couldn’t juggle around in this precise mathematical way with sound if you didn’t have a computer to do it for you.⁷³

⁷¹ *Tetramorph* (1972), *Tesserae 4* (1971) and *Poems of Wallace Stevens* (1970), according to Grogono, ‘MUSYS: Software for an electronic music studio’, p. 383.

⁷² Zinovieff, ‘A Computerized Electronic Music Studio’, p. 20.

⁷³ Peter Zinovieff quoted in *The Same Trade as Mozart*.

The film concludes with a performance of *M-Piriform* in a neoclassical building. The vocal and instrumental parts are performed by Jane Manning, Judith Pearce and Pauline Scott, while a tape recorder plays the computer-generated material over loudspeakers. Unlike Zinovieff's performance at the Queen Elizabeth Hall the previous year, the computer is not on stage – its job by this point is over. This dynamically filmed segment makes use of fast cuts and fades between the three performers – who are placed in different spots around the building – and a tape recorder, which is filmed as if it is a human performer, with close-ups of its reels and controls dissolving into close-ups of the performers' faces. This sets up a fluid, dramatic relationship between the acoustic and electronic elements of the piece, suggesting the possibilities and pleasures to be found in electronic music's 'artificial' nature while simultaneously presenting visual reminders of its kinship with more traditional music forms.

The Same Trade as Mozart ultimately promotes a composer-focused, rather than technocentric, portrayal of computer music. The composer, Justin Connolly, is given the last word, reflecting that, 'In many ways the problems of composition don't really change that much', as if to reiterate that the computer cannot provide easy solutions to those problems. It is he who coins the phrase that is the film's title, musing that the job of the composer is the same now as it was in Mozart's day. While the computer could enable the composer to bypass the human performer, the film chooses instead to highlight its capacity for creating electronic elements that could be used in combination with an acoustic ensemble.

Co-existing with the idea that making music with a computer was too 'easy' was an easily observable reality that it was, in fact, very hard, requiring resources and skills that very few musicians had access to. The job of Zinovieff and Connolly in *The Same Trade as Mozart*, facilitated by the film's sympathetic director, appeared to be to convince viewers that computer music was challenging enough to be aesthetically worthwhile, yet accessible and exciting enough to justify investing time and effort in it. A composer working at EMS would be rewarded by seeing their most complex musical ideas, unrealisable by other means, transformed by the computer into elegant sonic structures.

3.5.2 International perspectives on electronic music in society

The promoter of the Redcliffe Concerts of British Music, Francis Routh, championed EMS and MUSYS in his 1972 book *Contemporary British Music: The Twenty-five Years from 1945 to 1970*, remarking that, ‘With the arrival of the computer and the tape recorder the composer of electronic music has become his own performer, to a degree of exactness hitherto undreamt of’.⁷⁴

However, in the UK it proved hard to get widespread support for music made using machines that few musicians had ever encountered, and which were still unaffordable for many institutions, let alone individuals. The lack of success of Zinovieff’s proposals for a national computer studio point to the way in which the support that existed was dispersed and sporadic, confined to specialist pockets of interest rather than something that could be marshalled on a national level. Tristram Cary, while admiring Zinovieff’s work and heartily promoting EMS, did not see a use for the computer in his own studio and only began to work with computers himself in the late 1970s in Australia, while Zinovieff’s associates in the BBC Radiophonic Workshop were not yet ready to consider computerising their studios. Again, concerns about the creativity of the composer as well as the economic viability of the computer were at the fore. The Radiophonic Workshop’s director, Desmond Briscoe, commenting in 1977 to Canadian broadcaster Norma Beecroft, revealed his attitude towards digital music production by saying, ‘I think computer music is splendid for other computers to listen to’. Asked why the BBC Radiophonic Workshop had not yet invested in computer music, he responds,

We don’t say no because it’s new, but so far, and I get sent work from other studios and I listen to a lot, I listened a long time to Peter Zinovieff’s computer music, it doesn’t really have any application. By the time one has programmed a computer, all right, if one programmed it fully enough then one could produce applied music, but I think at the moment, the human being can produce it a good deal quicker. [...] I think that creative work, composition, is one of man’s more enjoyable functions. I certainly wouldn’t wish it to be handed over to any device.⁷⁵

⁷⁴ Routh, p. 299.

⁷⁵ Norma Beecroft, *Conversations with Post-World War II Pioneers of Electronic Music* (Toronto: Canadian Music Centre, 2016), p. 359.

Support for computer music was more likely to be found outside the UK. At the beginning of the 1970s EMS was part of a growing international community of studio managers, composers and educators in electronic music, a number of whom met on 8 June 1970 at the Fylkingen Society for Contemporary Music in Stockholm, for Art and Technology,⁷⁶ a five-day conference focusing on music and technology hosted by UNESCO. Instigated by Knut Wiggen of EMS Stockholm, the conference had various aims, one of which was to reinstate the connections between art and science that Wiggen hoped would attract more support for his studio from the Swedish government, then strongly in favour of scientific research in the service of the public good.⁷⁷ In putting together this conference under the auspices of UNESCO, Wiggen drew parallels between music, computing and the wider notions of progress, communication and peace that were key to UNESCO. While the conference was therefore driven to some extent by Wiggen's vested interests, it was also a key gathering of individuals representing various international approaches to music and technology in the 1960s and 70s.

Sanne Krogh Groth states that the focus at the conference was technological rather than aesthetic, philosophical or social,⁷⁸ but the English documentation of it, which was published the following year by the French journal *La Revue Musicale*, reveals only a small number of highly technical papers. Concerns about the very nature of electronic music and its impact on composers, listeners and society were more apparent. *La Revue Musicale*'s editorial director Albert Richard did not attend in person, but sent a paper, which was read out by Kaj Kauhonen of UNESCO, in which he set up a philosophical debate between a musician and an 'interrogator' that revealed fears about 'machine-produced sounds and sonic objects' similar to those that we have already encountered in this chapter, but expressed in strikingly dramatic tones, casting the musician as no more than a 'manufacturer'. In Richard's fictional debate, mechanized music's 'temporal fixity (with respect to our perceived time)

⁷⁶ Its proceedings were published by UNESCO and *La Revue Musicale* under the title *Music and Technology: Prepared for UNESCO on the basis of the papers and reports of the Meeting on Music and Technology, organized by UNESCO in Stockholm, Sweden, in June 1970* in 1971. References to individual papers and discussions are assigned to the relevant writers/speakers; the text as a whole is referenced as 'UNESCO' in the Bibliography and Footnotes.

⁷⁷ Groth, p. 83.

⁷⁸ *Ibid.* p. 84.

upsets the life and death of music’, while the possibility that machines afford for ‘permanent control ... destroys all possibilities of unity’.⁷⁹

Pedagogical perspectives, voicing both technical and aesthetic concerns, came from Gustav Ciamaga of the University of Toronto Electronic Music Studio (UTEMS) and Krzysztof Szlifirski from the Polish Radio Experimental Studio in Warsaw. A polemical, pro-technology stance was represented by Herbert Brün who, in response to Pierre Schaeffer’s suggestion that electronic composers should look at natural forms and structures for musical ideas, declared that nature ‘has produced a lousy society, a chaos.’⁸⁰ Out of all the delegates, Schaeffer seemed least comfortable with what he saw as the problems posed by the computer in music, namely: the computer’s role as instrument, instrumentalist, analyst and composer; which aspects of music could be ‘reduced to computation’;⁸¹ and how the roles of composer/initiator and technician/interpreter would play out in the new electronic music studio. Others, such as Max Mathews, Jean-Claude Risset and Gottfried Michael Koenig, shared practical examples from their respective studios, while Peter Zinovieff, although he did not submit to the published proceedings, gave a presentation on the work of EMS and played the delegates ‘A Lollipop for Papa’.

In his introduction to the proceedings, Kaj Kauhonen of UNESCO defined the conference’s main questions thus: ‘Has anything of lasting value been achieved during the last twenty years in musical composition by the use of the new means which technology has offered the composer? Does such music have a future?’⁸² The contributors’ attempts to impose various conceptual frameworks on electronic music can be read in part as a response to these questions: if the thinking around this new musical form could be formalised, perhaps its impact would be more measurable, and it would have a greater chance of being supported in the future by the institutions on which it depended for funding. Part of that formalisation was to do with the development of a shared language or languages of electronic music, the need for which was remarked on in the conference’s closing remarks, along with an idea of a ‘universal concept of technology’.⁸³ As Zinovieff is recorded as having remarked, this

⁷⁹ Richard, in UNESCO, p. 35.

⁸⁰ Helm, in UNESCO, p. 196.

⁸¹ Schaeffer, in UNESCO, p. 58.

⁸² Kauhonen in UNESCO, p. 9.

⁸³ Helm in UNESCO, p. 204.

included computer languages as well as the way electronic music was talked about, as, ‘language is a main problem for the composer in getting answers from a computer’.⁸⁴

At the same time as taking part in these formalising, historicising discussions, the participants were also aware of the transient nature of the technology that they were using; for example, Max Mathews remarked that although a hybrid system ‘will be the central facility in the electronic studios of the immediate future’, with the arrival of integrated circuits there would soon be ‘an all-digital real-time music machine’.⁸⁵ The documents I have referred to in this section – *The Same Trade as Mozart* and the UNESCO proceedings – set out to describe the current status and future possibilities of computer-based music at the beginning of the 1970s; however, they also partially capture the dynamic of this period, which I would propose is one in which these urges to formalize and progress are in constant dialogue with one another. This is a dynamic of innovation, which is to say one that holds within it the possibility of obsolescence as well as multiple rhythms of transformation, acceleration and deceleration.⁸⁶

3.6 Innovation and limitations

As we have seen in this chapter, users of hybrid studios such as MUSYS knew that they were dealing with a transitional technology that would be superseded by fully digital systems in the near future and were, in many cases, working towards this possibility. In 1971 Tristram Cary predicted that, ‘Within a year or two, the cheap desktop computer should enable a real computer studio to be built for little more than a good sized synthesizer’.⁸⁷ This was over-optimistic, and did not foresee the development of FM synthesis and ‘mixed digital’ devices such as the Synclavier and the Fairlight CMI (Computer Musical Instrument).⁸⁸ But only four years later, while John E. Rogers proposed ways in which a hybrid system might be streamlined to improve its real-time capabilities, he also noted that, at EMS in particular, ‘the current trend... is away from systems of this type and toward digital control of digital devices’.⁸⁹ Accounts by Dornbusch and Manning concur that, ‘Zinovieff had fully

⁸⁴ Zinovieff in UNESCO, p. 197.

⁸⁵ Mathews in UNESCO, p. 134.

⁸⁶ See Stiegler, *Technics and Time I*, p. 39.

⁸⁷ Cary, ‘Electronic Music – Background to a Developing Art’, p. 49.

⁸⁸ Manning, p. 257.

⁸⁹ Rogers, ‘The Uses of Digital Computers’, p. 217.

grasped the significance of digital technology' earlier and more significantly than many of his peers, even if he lacked the resources to fully explore it.⁹⁰

However, it would be a mistake to regard the early period of activity at EMS surveyed in this chapter as merely a prelude to more its more advanced stage. It also represents a short period of intense activity in which important ideas about electronic music were put into practice and introduced, via the compositions and media accounts described in this chapter, into contemporary music and the wider public. During this period, also, it appears that the dynamic working environment focused around technological innovation that was characteristic of EMS was established. In Grogono's opinion,

We were always working much too fast, discarding and replacing equipment before we had really learnt how to use it. Everyone kept asking Zinovieff to slow down a bit and produce some music, but he always wanted to improve the studio.⁹¹

The drive to improve is likely to have been rooted in constant frustration about the gap between what MUSYS was intended to do versus its actual capabilities. When questioned about MUSYS in the present day, Zinovieff talks about the limitations of the system as much as he acknowledges its important qualities. For example, when I asked how the MUSYS program and its implementation could have been improved – to be precise, I asked, 'What did MUSYS need that it didn't have?' – he responded,

Looking back on it now, I can see that it had to be a dead end. That, however much we improved the program or even made it work, the methodology was the wrong one for those days, and anything was likely to be too simplistic for the complex sounds which composers were interested in making. But to make very complex textures and things required something more than a simple structured program like MUSYS. That's how I see it. And no matter how many stages it went to, you never actually – all the examples you see written out are all very, very simple.⁹²

⁹⁰ Manning, p. 524, n.3.

⁹¹ Grogono, *Ricordanza*, p. 5.

⁹² Peter Zinovieff, interview with author, 2016.

However, the simplicity of the system also produced innovative solutions. The PDP-8's low cost and relatively fast processing speed was offset by a small memory capacity, which meant that users had to program it using assembly language, rather than one of the higher level languages that were becoming more widely available, such as FORTRAN, which Max Mathews had used to write MUSIC V. The memory was too small to run long subroutines that might be needed for a complex composition. Instead, inspired by the general purpose macrogenerator invented by Christopher Strachey in 1965, Grogono felt that macros – programs which can scan text and replace certain pre-defined words or phrases with symbols, thus saving memory and disk space – could make it possible for composers to write longer and more complex scores.⁹³ As more powerful computers with more memory capacity became widely available, this was less of an issue. However, in the early days of the studio, the use of this technology was a worthwhile innovation, reflecting the pragmatism of EMS's staff and their ability to make use of available resources, as can also be seen in the hardware that was built and, eventually, manufactured by EMS London Ltd (see Chapter Four).

As Grogono remarks, by 1973 – when he left EMS to take up a job in Canada – the hardware of MUSYS as he described it in his 1972 paper had already changed: for example, only one computer now remained in the system (the PDP-8/L, enhanced with a more powerful core and two tape drives). What had stayed much the same, however, was the MUSYS language – for all its limitations, and what Grogono describes as a 'barbarously hieroglyphic' quality, it provided a useful basis around which new hardware could be used and tested, and also was used in the development of VOCOM, Zinovieff's voice encoding project (see Chapter One).⁹⁴ Jim Lawson, an American programmer who joined the company after Grogono's departure, describes his work mostly as,

...at a low level – writing and interfacing with device drivers to communicate with the esoteric collection of studio equipment. Occasionally Peter Zinovieff would suggest higher level changes and I would do my best to implement them in the MUSYS code base or write macros or procedures performing equivalent functions.⁹⁵

⁹³ Grogono, 'MUSYS: Software for an Electronic Music Studio', p. 369.

⁹⁴ Ibid, p. 383.

⁹⁵ Jim Lawson, correspondence with author, 2018.

Lawson worked mainly with Peter Easty, one of the engineers who replaced David Cockerell when he also left to take up a job abroad in 1973 (working for guitar effects company Electro-Harmonix in New York, and then at IRCAM in Paris, too).⁹⁶ Thus not only did the technology of the studio change, its personnel also moved on to other studios and situations, in some cases taking ideas from their work at EMS and seeding them into other projects.

It is often the case that technological innovations are seen as useful only for short periods of time before they are superseded by another innovation. In the case of a hybrid digital-analogue studio, numerous innovations can be underway at the same time, with revisions in hardware and software being made at the level of concept, storage, connection, and many other points. This kind of interplay of innovation and revision pose certain challenges to the historian attempting to understand the processes of an early computer music studio.

3.7 Conclusion

In this brief picture I have given of the setting up and early use of MUSYS, it is possible to see how a constant process of invention, correction, debugging, discussion, rethinking, and close listening is central to audiothechnical environments. Our understanding of the relationships between technology, sound, sociality and innovation in these environments will always remain fragmentary, especially when they are no longer in existence. Media theorist Wolfgang Ernst reminds us to keep in mind ‘the more tricky technological artifacts, which are always just temporary configurations and not tightly coupled things’ and are thus more likely to be lost.⁹⁷ If hybrid synthesis is one of those artifacts, ‘finding’ it is not necessarily a case of tracking down an object or objects, but of trying to reconstruct a set of ideas through which its configurations were held in place, or, as a writer, examining the configurations of language by which it has been described.

In this chapter I have given an account of MUSYS through contemporary documentation and present-day interviews. I have looked at accounts of MUSYS in

⁹⁶ Pinch and Trocco, p. 288; Zinovieff, ‘From a Diary: Electronic Music’, in *PAGE 38* (1977), p. 5.

⁹⁷ Wolfgang Ernst, ‘Media archaeology: method and machine versus history and narrative of media’. In *Media Archaeology: Approaches, Applications, and Implications* by J. Parikka and E. Huhtamo, eds., (Berkeley: University of California Press, 2011), p. 114.

the media and the wider context of the UNESCO Art and Technology conference in order to situate the work of EMS in the musical-technological context of the late 1960s and early 1970s.

In the next chapter I will introduce EMS's intervention into the early synthesizer industry with the formation of the company EMS London Ltd, the production of the VCS3, a portable synthesizer launched in 1969, and the Synthi 100, a large synthesizer that was first manufactured in 1971. Rather than regarding the Synthi 100 – an analogue synthesizer with some digital features – in opposition to the computerised studio, I attempt to position it as yet another, if peripheral, component of the hybrid system as well as a separate object through which the musical, technical and design principles of EMS were articulated and thus dispersed into other studios.



Figure 3.2 Peter Zinovieff with teletype and PDP-8/S, c.1968. Source: unknown
[REDACTED]

```

2641 7001      IAC          /BUFFER ADDRESS+1
2642 3507      DCA I CORAD    /BECOMES POINTER
2643 5600      JMP I SSBL
/
/ DISC SUBROUTINE TO WRITE THE BLOCK
/ BLOCK NUMBER IN BLM; BUFFER ADDRESS IN BAD
/
2644 0000      WRD,      0
2645 1373      TAD BLM          /BLOCK NUMBER
2646 4456      CONV          /CONVERT TO DISC FIELD AND ADDRESS
2647 1371      TAD CNT
2650 3007      DCA C2          /SET TRANSFER LENGTH
2651 6601      IDS          /INITIALISE DISC
2652 5251      JMP --1
2653 1130      TAD DIFLD      /FIELD
2654 1372      TAD FT        /WRITE MODE
2655 6612      LDC          /SET MODE AND FIELD
2656 5255      JMP --1
2657 7300      LOOP,     CAL
2660 1110      TAD DISAD
2661 6615      LDA          /SET DISC ADDRESS
2662 5261      JMP --1
2663 7300      CAL
2664 1507      TAD I CORAD    /DATA
2665 6602      GDS          /TO DISC
2666 5265      JMP --1
2667 2107      ISZ CORAD      /STEP CORE POINTER
2670 2110      ISZ DISAD      /AND DISC POINTER
2671 7000      NOP          /MAYBE -1
2672 2007      ISZ C2
2673 5257      JMP LOOP      /64 TIMES
2674 7300      CAL
2675 5644      JMP I WRD
/
/ INITIALISATION ROUTINE FOR COMPILER SETS
/ PAGE 0 POINTERS TO BUFFERS AND ASSIGNS
/ FIRST BLOCKS OF EACH DISC CHAIN
/
2676 0000      SIN,      0
2677 1365      TAD FRAD
2700 3003      DCA T1          /FREE CORE ADDRESS
2701 1135      TAD BPNS
2702 3004      DCA T2          /BUFFER POINTER ADDRESS
2703 3133      DCA BLN        /CLEAR BLOCK NUMBER
2704 1370      TAD M10
2705 3375      DCA CNV
2706 1003      NEX,     TAD T1
2707 7001      IAC
2710 3404      DCA I T2      /STORE ADDRESS OF FIRST WORD
2711 2004      ISZ T2
2712 1133      TAD BLN
2713 3403      DCA I T1      /STORE BLOCK NUMBER IN BUFFER
2714 1003      TAD T1
2715 1367      TAD K100      /STEP BUFFER ADDRESS
2716 3003      DCA T1
2717 2133      ISZ BLN        /COUNT BLOCKS
2720 2375      ISZ CNV
2721 5306      JMP NEX      /8 TIMES
2722 5676      JMP I SIN
/
/ TERMINAL ROUTINE FOR COMPILER WRITES AWAY
/ EACH CORE BUFFER WITH ITS OWN BLOCK
/ NUMBER
/

```

Chapter 4

EMS London Ltd and the early synthesizer industry

4.1 Introduction

In 1975 the American composer Elliott Schwartz published *A Listener's Guide to Electronic Music*. In a chapter on the synthesizer, Schwartz made the observation that, prior to its invention, all the equipment that people used to make electronic music 'had been originally intended to serve other purposes'.¹

Subsequent accounts of electronic music's early history and prehistory² have brought to light early 'electro-music' instruments such as the Theremin and the Trautonium, which predate the synthesizer by some decades. These accounts remind us that the synthesizer developed within a continuum of purpose-built mechanical, electrical and electronic musical instruments, but also that these early examples were, until fairly recently, rarely documented or even known about. Additionally, while the synthesizer appeared to bring different components together and encase them within the boundaries of something that increasingly looked like a musical instrument, within those physical boundaries the synthesizer's identity as a discrete musical instrument was not immediately assured. A synthesizer to which modules could be added, taken away and reconfigured was just as easy to envisage as a collection of instruments, while even a small, self-contained synthesizer such as the EMS VCS3, the origins of which are described in this chapter, was designed to contain multitudes – the initials in its name stand for 'Voltage-Controlled Studio'. A synthesizer could be an instrument or instruments, plural, a studio in its own right or an installation within a studio, often at the same time. Even a temporary physical configuration of parts of the synthesizer could be an instrument: it was not uncommon for users of the EMS Synthi 100 to refer to a patch that they had set up as an 'instrument', as if the synthesizer was synonymous with a musical ensemble as well as a studio. A visitor to EMS studio in

¹ Elliott Schwartz, *Electronic Music: a Listener's Guide* (New York: Praeger), p. 70.

² see Joel Chadabe, *Electric Sound: the Past and Promise of Electronic Music*. (London: Prentice-Hall International UK, 1975); Thomas Pattenon, *Instruments for New Music: Sound, Technology, and Modernism* (Oakland: University of California Press, 2016).

1969 would not have seen anything that was easily recognizable as a musical instrument; rather, as the previous chapter describes, the studio was set up as a hybrid system of computers, converters and analogue sound-making devices. When EMS began producing what ostensibly looked like instruments, it was this system that provided the guiding principles, rather than any acoustic instrument.

The question of what constitutes an instrument still arises when we talk about electronic music now. It is common to refer to instruments in digitally created music, for example when talking about soft synths or plug-ins for digital audio workstations, or a patch created in Max/MSP or Supercollider, but there are still discussions about whether or not a laptop – a device certainly invented for ‘other purposes’ – is or is not an instrument, especially in regard to musical performance, suggesting that the notion of ‘the instrument’ is still an important legitimising term that is closely associated with musicianship and musicality. Yet this notion has routinely been challenged by many experimental and electronic music cultures, from early examples such as John Cage’s *Cartridge Music*,³ which uses pick-ups from record players as its main sound source and Hugh Davies’s collection of homemade electronic instruments,⁴ to an acceptance across various musical fields of devices such as turntables and records, samplers, drum machines and digital controllers as instruments on which it is possible to demonstrate skill, technique and originality. Rather than joining an existing family of acoustic instruments, we could say that invention of the synthesizer was a reminder, and a prediction, of electronic music’s complicated relationship with ideas of instruments and instrumentality.

This chapter gives an overview of EMS’s entry into the synthesizer market in 1969, when Peter Zinovieff, David Cockerell and Tristram Cary formed EMS London Ltd to produce and sell the VCS3 and, subsequently, a small range of synthesizers and other devices. In this chapter I examine the attitudes of EMS’s founders to the synthesizers they produced, which has tended towards the dismissive. I put this in the context of Zinovieff’s frustrated plans for a national electronic music studio; new directions in live electronic music performance; and the concerns about widely available synthesizers voiced by some of their earlier adopters. To conclude the

³ John Cage, *Cartridge Music* (1960).

⁴ Although as Fiorenzo Palermo points out in ‘Instrumental Trouble: a Queer Organology of Hugh Davies’s Found Instruments’, Davies’s ‘shozygs’ have often not been considered instruments, because they challenge ‘normative’ assumptions of what a musical instrument should be. Palermo, *Inter Alia: A Journal of Queer Studies* (2019).

chapter I introduce the Synthesizer 100, the large analogue synthesizer with a built-in digital sequencer that EMS launched in 1971, contrasting its ‘time-creating’ capacities with the ‘time-saving’ promise of the voltage-controlled synthesizer.

4.2 Instrumentality, technology and electronic music

Recent approaches to electronic music history from material culture perspectives have examined the relationships between inventors’ and manufacturers’ aims for and the eventual usage of electronic sound devices, rather than assigning them the status of ‘instruments’ or ‘non-instruments’, discussing microphones, loudspeakers, mixing desks and devices such as drum machines within the same field as objects intended from the start to be musical instruments: see, for example, Sarah Angliss on early drum machines and Sean Williams on the low-pass filter in Tim Boon and Frode Weium’s edited collection, *Material Culture and Electronic Sound*.⁵ Similarly, in recent debates in organology, the multiple usages and meanings of electronic instruments can generate new, interdisciplinary studies of music and technology, hinted at in John Tresch and Emily Dolan’s comparison of the parallel development of music and scientific instruments in ‘Toward a New Organology’.⁶ Their proposal of an ‘ethics’ of musical instruments (see Chapter One) has extra-musical implications, as can be seen in the writing of Bernard Stiegler on the relationships between social, technical and human organizations, in which music is sometimes brought forward as an illustration. While Stiegler’s concept of a ‘general organology’ encompasses far more than the use of the term to describe the study of musical instruments, he also proposes an ‘extension of music’s organological grounds’ afforded by developments in technology, in which machines are integrated into instrumental contexts, become instruments or affect how instruments are played.⁷ Throughout his writing, Stiegler has drawn significantly on the writing of philosopher Gilbert Simondon, whose notion of concretization can help explain how a technical object becomes separated from its origins in the laboratory, workshop or factory and takes on a concretized status as ‘its

⁵ Frode Weium and Tim Boon, *Material Culture and Electronic Sound* (Washington: Smithsonian Institution Scholarly Press, 2013).

⁶ John Tresch and Emily Dolan, ‘Toward a New Organology: Instruments of Music and Science’, *Osiris*, 28 (2013), pp. 278–298.

⁷ Bernard Stiegler, *Symbolic Misery 2: The Katastrophe of the Sensible* (Cambridge: Polity Press), pp. 10, 11.

internal coherence increases' and it forms relationships with other objects.⁸ Although Simondon, in his key work *On the Mode of Existence of Technical Objects*, writes primarily of industrial processes, the combinatorial, modifiable character of an electronic musical instrument lends itself to this analysis too.

A media archaeological viewpoint further disturbs the definitions of instrument and reappropriated scientific device by pointing out, and indeed finding creative possibilities in the fact that the components of a technology developed for one purpose were frequently developed in other, contrasting industries. For example, Wolfgang Ernst isolates one component, the electron tube, which was vital to radio but also has had many other uses in amplification, broadcasting and computing, to make a connection between the histories of radio and the early computer music of Lejaren Hiller – between the 'half-life of one hundred years of radio tube' and 'fifty years of tube-based computer music' – as well as the first digitally synthesized sounds produced at Bell Labs in 1957.⁹ Ernst's point is that particularity in usage is not always more interesting or productive than the generic, and the seemingly unconnected 'harmonia' between technologies. Pointing out the generic aspects of a machine allows us to see it as part of a wider organology of technical objects in society, in order to think about it as part of a wider social and technical framework; it is here that correspondences might be found between studies by media archaeologists, organologists and sociologists of music.

However, while an electronic musical instrument can be usefully abstracted and thought of as a technical object like any other, its cultural and social significance as a musical device is also important. For a composer like Elliott Schwartz, a pianist and teacher who was, for a short time in the 1960s and 70s, an enthusiastic adopter of but not an expert in electronic techniques, the notion of the synthesizer as a discrete electronic musical instrument – rather than a studio in which the functions of a synthesizer are undertaken by a number of connected devices such as oscillators, filters and so on – had useful practical implications. The synthesizer's legibility as an instrument helped to define electronic music as an area that could have an instrumental practice like any other. It also, clearly, had implications for educators such as Schwartz, who now had a manageable tool for teaching students about the

⁸ Gilbert Simondon, *On the Mode of Existence of Technical Objects*. 1958, translated from French by C. Malaspina and J. Rogove, 2016. (Minneapolis: Univocal, 2016), p. 58.

⁹ Wolfgang Ernst, *Digital Memory and the Archive* (University of Minnesota Press, 2012), pp. 170–1.

basics of electronic sound that did not require a large studio or expensive equipment. It is easy to see the appeal of such a solution developed specifically with the composer and musician in mind, and to understand why Joel Chadabe, Schwartz's contemporary, and a composer who worked closely with Robert Moog on his early synthesizers, identified the invention of the voltage-controlled synthesizer as the 'third milestone' in the history of electronic music.¹⁰ It represented the beginnings of a shift away from electronic music as primarily a set of processes and ideas and centered it instead around devices. It also meant that electronic music was now associated with specialist products that that could be bought and sold from specific manufacturers.

The first synthesizer makers played an important part in establishing the synthesizer's instrumental status, as Trevor Pinch and Frank Trocco describe in their account of the 'social construction' of the Moog synthesizer.¹¹ They describe photographs of the Moog Series 900 in which its player, musician John Weiss, is posed simultaneously adjusting a potentiometer knob and playing a keyboard connected to the synthesizer. This, posture, 'deliberately used' in Moog's advertising, helped to cement the view that this strange installation of wires and dials was also capable of allowing musical expression, like a piano or organ (as Weiss remarks, the pose 'graphically ties in the music and technology'). It is Pinch and Trocco's claim that Moog's inclusion of a keyboard with their synthesizers from early on made them more successful than their peers. By not including a keyboard controller, other makers – in particular Don Buchla – aimed towards a new kind of instrumentality and, by extension, a different approach to composition than one that starts from the keyboard. As I will discuss later, the designers of EMS London Ltd's synthesizers also had an ambivalent attitude towards the keyboard.

As well as Pinch and Trocco's studies of the Moog synthesizer and its competitors, other writers including Paul Théberge, Mark Brend, and James Gardner have documented how the invention of the synthesizer led to the growth of a small market in the 1970s, mostly in the US and the UK, expanding an audio engineering industry previously based on peripheral devices such as speakers, amplifiers and so on

¹⁰ Representing a progression from proto-electronic instruments such as the Telharmonium, and the sound-objects, turntables and tapes of musique concrète. Chadabe, p. ix.

¹¹ Trevor Pinch and Frank Trocco, 'The social construction of the early music synthesizer', *Icon* 4 (1998), 9–31, p. 16.

into what could be called a nascent music technology industry.¹² In terms of electronic music cultures and the adoption of electronic music-making, Théberge has documented the rise of music technology magazines and journals in the US, while Ian Helliwell has noted the presence of home-built synthesizers in the UK, as synthesizer kits began to be published by companies such as DEW (Design Engineering Wokingham) – who started manufacturing voltage-controlled modules in the early 70s, and progressed to the VCS3-inspired Dewtron – and *Practical Electronics* magazine, which advertised its own PE Sound Synthesizer.¹³ These studies have in common a focus on the makers, designers and companies who originated the instruments. In broadening my focus to include individuals and institutions which used EMS synthesizers, I am proposing another way in which an instrument's identity can be constructed and understood.

Théberge has identified how the 'hagiographic' histories written of synthesizer innovators focus on the lone innovator and 'individual genius' rather than understanding the invention of a particular device as 'the outcome of a particular interplay of social forces and local initiatives'.¹⁴ In advancing the perspectives of the various users of an instrument – from musicians and composers to studio managers, technicians, sales assistants, engineers and restorers – it is possible to think about different kinds of interplay: not just that which contributes to an instrument's invention, but also the interplay of musician and device, of composer and institution, of supplier and client, and many other interactions that contribute to the 'social life' of an instrument, including the role of audio-technical media such as audio engineering and audiophile magazines.¹⁵ However, Théberge does not fully explore the political implications of the narrow hagiographic tendency he identifies: namely, that it obscures the stories of other, less visible participants and different kinds of participation. This has been left to feminist historians such as Tara Rodgers, whose research on public responses to the RCA Mark II Sound Synthesizer reveal

¹² Paul Théberge, *Any Sound you can Imagine: Making Music, Consuming Technology* (Hanover: Wesleyan University Press, 1997); Mark Brend, *The Sound of Tomorrow: How Electronic Music was Smuggled into the Mainstream*. (London: Continuum, 2012); James Gardner, 'The Don Banks Music Box to The Putney: The Genesis and Development of the VCS3 Synthesiser', *Organised Sound* 22: 2 (2017), 217–227.

¹³ Ian Helliwell, *Tape Leaders: A Compendium of Early British Electronic Music Composers*, (Cambridge: Sound On Sound, 2016), p. 190

¹⁴ Théberge, p. 43.

¹⁵ cf. Arjun Appadurai (ed.), *The Social Life of Things: Commodities in Cultural Perspective*. (Cambridge: Cambridge University Press, 1984)

documentation of women's interest in the synthesizer, in the form of letters written to RCA by young women soon after the Mark II's invention.¹⁶ Similarly, some writers of recent studies of computing history have forefronted the work of female programmers and operators as well as challenging assumptions about non-white participants in technology.¹⁷ Inherent in these studies, and in mine, is a concern for the question of how a technology comes to be known, and what it means to know (about) it. Here, I bear in mind Donna Haraway's writing on collective, reflexive and 'situated' knowledge, aiming to be 'committed as much to knowing about the people and positions from which knowledge can come and to which it is targeted as to dissecting the status of knowledge made'.¹⁸

To return to instruments and instrumentality, there are useful parallels between Haraway's feminist science and technology studies and the ethical organology proposed by Tresch and Dolan, not least for the ways in which both allow for an instrument's meaning and identity to change as it is used over a period of time, and by different groups and communities. Haraway encourages close readings of the language used in shaping the dynamics of experimental scientific environments, which have many parallels with the environments of experimental electronic music, such as the studio. It follows that ideas about what constitutes an instrument – and who does or does not gain knowledge of the instrument – may also shape how electronic music environments are constituted.

4.3 The VCS3

The relationship between the development of musical instruments and musical styles and practices has long been regarded by sociologists of music as a dynamic process involving composers, musicians and instrument builders working in collaboration with one another. Historically, instruments have been developed for certain players and composers, or modified in order to suit a new instrumental groupings such as a string quartet or to satisfy demands for certain musical effects: for example, Max Weber

¹⁶ Tara Rodgers, 'Tinkering with Cultural Memory: Gender and the Politics of Synthesizer Historiography', *Feminist Media Studies* (Fall 2015), 5–30.

¹⁷ See Marie Hicks, *Programmed Inequality: How Britain Discarded Women Technologists and Lost Its Edge in Computing* (Cambridge, Mass: MIT Press, 2017); Wendy Hui Kyong Chun, *Programmed Visions: Software and Memory* (Cambridge, MA: MIT Press, 2011).

¹⁸ Donna Haraway, *Modest_Witness@Second_Millennium.FemaleMan-©_Meets_OncoMouse™: feminism and technoscience* (London: Routledge, 1997), p. 36.

describes how the violin, in sixteenth century Italy, developed in response to demands from court orchestras for an increasingly sonorous tone, as well as a visually elegant instrument.¹⁹

Such interactions with composers were also key to the development of the synthesizer. Robert Moog's first modules, built in 1964, evolved through collaboration with composers Herb Deutsch and Wendy Carlos, and with the support and patronage of Gustav Ciamaga at the University of Toronto,²⁰ while Don Buchla worked closely with Morton Subotnick and Ramon Sender at the San Francisco Tape Music Center when designing his synthesizers.²¹ Although Peter Zinovieff and David Cockerell had developed a number of devices for their own use in the studio prior to 1969, the first commercial EMS synthesizer originated from conversations with the Australian composer Don Banks, for whom the prototype for the VCS3, known as the VCS1 or the Don Banks Music Box, was made. The nature of this relationship was rather less collaborative than those detailed above: Banks, who was interested in but had little experience of electronic music, wanted a cheap, portable instrument on which he could begin experimenting with electronic sound, but that was about as far as his specifications went. In his essay on the origins of the VCS3, Gardner notes that, although the small synthesizer was designed specifically for the composer,

the DBMB's [Don Banks Music Box] design specification did not come from Banks himself. According to his 1972 account, he deferred to Zinovieff and Cockerell as to "which facilities [...] one would need to know about" – note the imperative. It could be argued, then, that one of the main determinants of the DBMB design was Zinovieff and Cockerell's opinion of what a composer ought to find useful.²²

¹⁹ Weber also notes – in an interesting correspondence with the odd temporal relationship between technologies, instruments and culture – that, 'What such technical development offered in possibilities, once perfection was achieved, far surpassed what had been demanded. The performance capacity of the Amati instruments was not really exploited for many decades. In the same way as the single violin, following an ineradicable conviction, first had to be "played in" and had to wait a generation before it could reach the full height of its rendition potential, so the adaptation and introduction also as compared with other instruments occurred only very slowly [...] Its availability as a special solo instrument of virtuosi could not have been guessed beforehand by the builders.' Max Weber, *The Rational and Social Foundations of Music*, translated from German and edited by Don Martindale, Johannes Riedel and Gertrude Neuwirth. (Carbondale, IL: Southern Illinois University Press, 1958), pp. 109–10.

²⁰ Pinch and Trocco, *Analog Days*, pp. 14–16.

²¹ David Bernstein (ed.), *The San Francisco Tape Music Center: 1960s Counterculture and the Avant-garde* (Berkeley: University of California Press, 2008).

²² Gardner, 'The Don Banks Music Box to The Putney', p. 220.

Banks was introduced to Zinovieff and Cockerell through Tristram Cary, whom he knew via shared contacts in film and television – like Cary, he composed numerous film soundtracks. In Cary’s memoir, he describes how Banks’s synthesizer evolved to become the VCS3 – the first commercial product to be launched by EMS London Limited. Cary recalls how the VCS1, a ‘little grey box’ with its simple arrangement of three voltage controlled oscillators, filters, a noise generator and a ring modulator, was expanded by himself, Cockerell and Zinovieff into a larger instrument, which among other improvements, incorporated input amplifiers so that the synthesizer could also be used as a processor for external signals. Looking for a more efficient, cost-effective and neater way of patching the synthesizer’s modules than the ‘post office’ style cables used by Moog – and using materials that were easy and cheap to source from electronic surplus shops – the designers decided upon the pin matrix that would become a distinctive feature of all the EMS synthesizers. Cary writes,

Someone sketched out a shape like a miniature desk with two panels, the upper nearly vertical one to have all the control knobs and the lower, horizontal panel to house the pin matrix, some sort of stowage for pins not in use, and a little joystick by which one could manually generate control voltages.²³

Using this sketch, Cary put together a prototype of the desk at his own studio in Suffolk, and gave it to Cockerell, who installed the circuits. Within days, ‘we had the very first VCS3 up and running’.²⁴ Cary’s account gives a sense of the collaborative, experimental environment in which the first EMS synthesizer was developed, through conversations, sketches, pragmatic use of the materials to hand, and a congenial relationship between the three designers and the composer who had commissioned the instrument. (As Gardner notes, ‘there are very few records concerning the design process of EMS products. Most discussions of this nature are likely to have taken place informally and orally.’)²⁵

When EMS London Ltd was established as a company in July 1969, Cary was listed as a director alongside Zinovieff and Cockerell. Later that year, the first VCS3s were sold. The new company wasted no time in expanding its operations outside of

²³ Tristram Cary, *Autobiography*, Ch.16.

²⁴ Ibid.

²⁵ Gardner, ‘The Don Banks Music Box to The Putney’, p. 217.

the UK: by early February 1970, *Billboard* magazine reported that, ‘The electronic music field is being primed for a marketing jolt with the introduction of a new electronic voltage-controlled studio named Putney’.²⁶ The alternative name for the VCS3 was suggested by EMS’s first US distributor, Albert Mayer, as being more appealing to an American market which, Cary writes, ‘we were advised prefers names to numbers’.²⁷ In the UK, *Studio Sound* magazine reported in the Studio Diary section of its May 1970 issue that a new synthesizer had been launched by Electronic Music Studios London Ltd, retailing for £330.²⁸ In the same issue’s masthead, editor John Crabbe wrote enthusiastically of the new wave of voltage-controlled synthesizers, which could provide ‘an almost unlimited range of tone colours’. The only drawback was the prohibitive cost of Moog’s systems, to which the budget-priced, British-made VCS3 provided a solution. He concluded,

There is little doubt in our mind that, once the mass-production boys realize the simplicity of these electronic synthesisers, the market will be flooded with low-price mini-Moogs. The hegemony of the electric guitar might then be ended, and with it might go the tyranny of the piano keyboard. The VCS3 doesn't have one.²⁹

Crabbe turned out to be wrong on a number of counts. As Moog discovered, keyboard-based synthesizers proved to be the most successful precisely because they shared a morphology with the piano – and, given that the piano keyboard, in turn, had helped to shape the design of typewriters and other writing machines, helped to ‘concretize’ the synthesizer as a technical object in relation to a recognisable family of other apparatuses.³⁰ What appeared to be an exciting innovation from an engineering

²⁶ *Billboard*, ‘Putney Bows \$1G 'Synth', 7 February 1970, p. 78.

²⁷ Tristram Cary *Illustrated Compendium of Musical Technology* (London: Faber & Faber, 1992), p.xxv). In an article for *Audio* magazine that doesn’t reveal his own commercial stake in the VCS3, Mayer emphasized the extra-human properties of the synthesizer, claiming that, ‘At maximum, an individual with 10 fingers and two feet can sound 12 tones. With electronic devices as many tones can be sounded as the listener can comprehend, they can produce any number of rhythms simultaneously, accurately and with absolute calm and ease.’ Hinting at one market he had in mind for the synthesizer, he enthused that ‘a sound effects man could just go out of his mind dreaming up all the new sounds he can generate on a voltage control unit.’ Alfred Mayer, ‘A New Electronic Synthesizer’, *Audio*, May 1970, p. 28.

²⁸ *Studio Sound*, ‘Studio Diary’ May 1970, p. 186.

²⁹ John Crabbe, ‘Editorial’, *Studio Sound*, May 1970, p. 183.

³⁰ cf. Simondon, as well as Bernard Stiegler, *Technics and Time, 1: The Fault of Epimetheus*, translated from French by S. Barker (2000), (Stanford: Stanford University

perspective could be seen as a musical disadvantage. Similarly, reviewers enthused about the neatness of the VCS3's pin matrix compared to a Moog system's patch cables, and predicted that this would become a standard feature of synthesizers. In fact, although the ARP 2500 (launched in 1970) used a similar interface, it was only EMS that used the pin matrix model for any length of time – and many present-day modular systems such as Doepfer's Eurorack range use traditional patchbays and cables.

If the 'mass-production boys' were going to choose any electronic instrument to support, it would be the one that was the most familiar to the consumer, as Don Buchla reflected in an interview with, ironically, *Keyboard* magazine in 1982 – by which time the synthesizer market really had embraced mass production, but not of experimental voltage-controlled synthesizers. 'The market for the instrument doesn't exist for many years after the R&D that goes into developing a truly new instrument,' he explained. 'With short-term profits a primary motive, the big corporations are simply not interested.' This led to companies producing instruments that could be immediately mastered by musicians; in most cases, with an organ-style keyboard. But Buchla noted that, with such a keyboard,

You're going to continue to talk about the same form of a note, and the same pitch structures that we've been listening to for so long. Certain aspects of the music are going to be dictated by the nature of the input structure, and by the correlation between that and the sound-generating structures. That is, we don't sit down at a conventional keyboard and expect to perform something other than 12-tones-per-octave music.³¹

However, as Buchla pointed out, he had never actually aimed to produce instruments for the popular market. While *Studio Sound*'s editor was probably thinking of the VCS3 within the framework of popular music with his remark about electric guitars, this market had not been EMS's target, either, although the VCS3 and its successors the Synthi A and AKS were taken up by a number of British rock groups. This was an indication that trends within rock music were changing to incorporate non-tonal

Press, 1994), pp. 70-72. See also Tresch and Dolan, 'Toward a New Organology', pp. 286–287.

³¹ Buchla quoted in Jim Aikin, 'The Horizons of Instrument Design: A Conversation with Don Buchla', *Keyboard*, December 1982.

elements, studio techniques and electronic sounds that were not mimetic of other instruments, rather than a case of EMS's designers identifying these customers. The VCS3's suitability for composers making non-tonal music with clearly 'electronic' elements was informed by Cary and Zinovieff's experiences in electronic concert music, soundtracks and, in Cary's case, electronic sound for broadcasting: it is significant that reviewers of the VCS3 also wrote of how well it could generate sound effects reminiscent of waves and wind, while finding a realistic 'organ' sound was far harder.³² The DK1 keyboard was launched in 1970 to accompany the VCS3 but, like the touch-plate keyboard that was built into the Synthi AKS, this required careful tuning, and was less something to be 'played' and more of a controller, similar to the joystick that had been included in the VCS3. With the AKS, one of its functions was to programme the sequencer that was included with the synthesizer. If one did want to play a tune, and accordingly set up the keyboard to connect to the frequency control of an oscillator, users were warned that the touch-plate keyboard meant that, 'playing from music became rather more difficult than improvising. Unless a close watch is kept on the keyboard, a performer's fingers may drift from the key centres'.³³ An EMS brochure from 1971 lists a soon-to-be-available instrument 'specially designed for live performance' called the KB1, which appears to combine most of the features of the Synthi A (the more portable 'briefcase' version of the VCS3) with a built-in keyboard,³⁴ but this never went beyond the prototype stage; neither did the VCS4, a precursor to the Synthi 100 that connected two VCS3s with a keyboard.

Like Buchla's instruments, EMS synthesizers were primarily set up for experiments in sound and timbre. Their relative accessibility and low cost, compared at least with Buchla's instruments, meant, however, that notions of who wanted to experiment with sound and why, and indeed what constituted experimental music practice, expanded beyond the intentions of the VCS3's makers.

As to the mass-market possibilities of the synthesizer, while EMS expanded its operations rapidly between 1969 and 1973, it did so on a scale typical of a small to medium-sized business. Hilton Electronics, a small company based in Wareham, Dorset, was acquired and became a subsidiary of EMS, and it was here that the synthesizers were assembled and tested. In 1974, a report on EMS prepared by Alan

³² David Kirk, 'The Fine Art of Voltage Control', *Studio Sound*, March 1971, p. 172.

³³ David Kirk, 'Field Trials', *Studio Sound*, February 1973, p. 43.

³⁴ Alan Sutcliffe Archive. MS/2160: Financial Material + Price Lists

Sutcliffe for possible investors described the Hilton factory as employing ‘about 24 production workers’;³⁵ Les Hayward, who worked there as a product tester from 1971–72, remembers it as a smaller operation, estimating that the production line employed only around eight people, with four testers such as himself, and the staff as a whole numbered around fifteen,³⁶ indicating that the factory grew in 1973 to accommodate the growing range of equipment made by EMS.

A ‘family’ of products soon began to evolve that would be photographed grouped together on brochures and adverts, with an impressive-sounding list that now included the Synthi Sequencer 256 and peripherals such as a filter bank and a pitch-to-voltage converter. By mid-1971 EMS were demonstrating what they now called their ‘Synthi Systems’ at the Association of Public Address Engineers’ annual conference (see Fig. 4.4), while representatives from the company attended similar events in the UK and abroad. Robin Wood, who had joined EMS in 1969 as a general studio assistant, was employed to deal with customers and demonstrate the VCS3 at a shop at 277 Putney Bridge Road, close to the EMS studio in Deodar Road; he also took part in demonstrations at international trade fairs.³⁷ Wood recalls that,

Peter [Zinovieff], typically, wouldn’t – he didn’t like to get involved in those, so I’d drive a van with all our gear to Frankfurt every winter and do the stand with our German agent, Ludwig Rehberg. Ludwig became very important to EMS – he started to take a real leading role in sales and he had a little flat at the top of Putney Bridge Road where he could stay for a few days fairly regularly.³⁸

Zinovieff and Tristram Cary visited the US several times in the early 1970s to attempt to promote EMS’s products in North America: Cary recalls that one of their trips included a visit to Robert Moog’s Trumansburg factory, as well as Bell Labs, where they met Max Matthews, and the Columbia-Princeton studio where Milton Babbitt showed them the RCA synthesizer.³⁹ An article in the American magazine *Record World* from October 1971 features a short interview with Zinovieff and Cary, who are

³⁵ Alan Sutcliffe Archive. MS/2160: Financial Material + Price Lists

³⁶ Les Hayward, interview with author, 2018.

³⁷ Another demonstration site was briefly set up in 1972 at a shop belonging to a company called Phasor Electronics in Finchley, North London, according to an advert in *Studio Sound* (1972).

³⁸ Robin Wood, interview with author, 2018.

³⁹ Tristram Cary, Ch.17.

described as ‘basically serious composers who invented the instrument for their own use’. A photograph shows them holding a Synthi A, which Zinovieff claims, ‘can make an infinite number of sounds’. The article reports that the two men are visiting New York in order to set up a US operation to be run by an investor named Robin Leach – a move which, Cary claims, will enable the Synthi A to be mass produced.⁴⁰

In its first few years as a company, EMS London Ltd grew within the limits of a small business working within a very niche field. The company was also, as we have seen in the previous chapters, only one of a number of activities with which Zinovieff, Cockerell and Cary were engaged. Much of Zinovieff’s time and attention was dedicated to his studio, to his ongoing collaboration with Harrison Birtwistle on compositions (including their long-running collaboration *The Mask of Orpheus*) and to advocating for a national facility for electronic music through his involvement in the British Society for Electronic Music. This scheme, if it were to achieve the backing Zinovieff hoped for, would obviate the need to produce synthesizers at all, as his studio would be nationally owned and supported by government funding.

As Zinovieff presented talks, submitted proposals and gave interviews promoting his and BSEM’s bid for the national studio, the synthesizer business was either not mentioned at all or was cast as subsidiary to this more elevated and more worthy aim. For one thing, the synthesizer business complicated the plan for EMS to become a national studio, because, as stated in a proposal put to the Calouste-Gulbenkian Foundation in 1971, ‘the studio now belongs to the company’. However, the proposal continued, EMS could contribute to the plan for the national studio by supplying equipment, staff and technical support.⁴¹

In the following section, I consider the ambivalence voiced by Zinovieff, Cockerell and a number of musicians about the rise of the synthesizer in the early 1970s. Acknowledging and exploring this ambivalence helps us to understand the musical and cultural environment in which EMS developed their instruments, as well as the nature of the technology that made those instruments possible.

⁴⁰ Mike Sigman, ‘The Case for Synthi A’, *Record World*, 2 February 1971. According to various sources, it was due to financial mishandling by Leach that EMS’s VOCOM project failed, leading to the decline of the company.

⁴¹ Daphne Oram Archive 1/2/057: Calouste Gulbenkian.

4.4 Saving time: voltage-control synthesis

In the way in which it was conceptualized and marketed, the synthesizer was often portrayed as a time-saving device, like many other products developed in the twentieth century to automate repetitive processes. According to Elliott Schwartz, the synthesizer relieved ‘the massive time-waster of the electronic studio’, in hugely simplifying the process by which electronic signals could be generated and controlled by the composer, who, as electronic musical instruments became more accessible, was increasingly likely to be the performer and maybe the engineer, too.⁴²

This allowed for other contractions as well as those of professional and creative roles: the temporal distance between the sounds and the structure of an electronic composition was reduced as electronic sounds could be produced in the split-second it took to alter an electronic signal by pressing a key or turning a dial. In this new sonic environment the composer, wrote Reginald Smith Brindle, ‘is free... to work with sounds *in movement*, to move with them through space by any devious path he may choose’.⁴³ For composers who had been frustrated by the slow, painstaking process of working with tape, the synthesizer brought the possibility of working directly with sound, which was, according to composer Bob Ostertag, who encountered the shift from tape to voltage-controlled synthesis as a young musician in the 1970s,

a very enticing idea: since both the shape of the sound and the shape of a composition could be controlled in the same world of automated voltages, complex and surprising systems could be set up within the synthesizer itself.⁴⁴

A measure of autonomy for these sounds was also possible: even a small synthesizer like a VCS3 could be set up, to some extent, to generate patterns and ‘play itself’.⁴⁵

This integrated ‘world’ that Ostertag writes of was made possible by using voltages to control sound, an idea that Robert Moog began exploring in the early 1960s, inspired by the new common-emitter transistors that acted as amplifiers in transistor radios. These transistors were used as a means of changing the frequency of an oscillator, or the gain of an amplifier, by changing a ‘control voltage’ to alter qualities such as frequency and intensity that correspond with musical qualities such

⁴² Schwartz, p. 70

⁴³ Reginald Smith Brindle, *The New Music: The Avant-Garde since 1945*, 2nd edn. (Oxford: Oxford University Press, 1987), p. 110.

⁴⁴ Bob Ostertag, ‘Human Bodies, Computer Music’, *Leonardo Music Journal*, 12 (2002), 11-14 (p.12).

⁴⁵ Brindle, p. 110.

as pitch and loudness; so, for example, an increase or decrease in voltage supplied to an oscillator could be used to change its pitch. The simplicity and transferability of this idea to various devices meant that they could be connected into a ‘modular’ system where one device’s output could control or process another, in increasingly complex networks (resulting in Ostertag’s ‘systems’). The principle behind the smaller, discrete synthesizers that developed from these larger systems, such as the VCS3 and the Minimoog, was the same: control voltages were used to generate and control sound through a number of linked components. The number of modules and functions was reduced, giving fewer options to the musician to modify or expand their instrument, but making it easier for the synthesizer to become formalized as a recognizable instrument, and thus more accessible, both to musicians new to electronic music, and to the marketplace. This reduction in scale was portrayed as a time- and labour-saving progression for the musician; however, those same qualities could also be criticized for limiting musical expressivity, as I will show later in this chapter.

Moog’s findings were published in *Society of Audio Engineering* journal in 1965 in a paper titled ‘Voltage-Controlled Electronic Music Modules’.⁴⁶ Tristram Cary notes that Moog’s schematics would have been available to EMS’s engineer David Cockerell through this publication, while Brian Hodgson recalls that Cockerell and his predecessor Mark Dowson had been experimenting with voltage control in the various devices they built for Zinovieff’s studio from the mid-60s onwards.⁴⁷ Cockerell has said that the first device he built for EMS was a voltage-controlled oscillator, and that some of his designs, such as the VCS3’s low-pass filter, were inspired by Moog’s.⁴⁸ But in an interview with James Gardner, he remarks that ‘at the Putney studio we soon got past voltage control and got into this computer control of everything.’⁴⁹ The ‘world’ of control voltages, while initially inviting, was far less sophisticated than that of the computers that ran EMS’s studio.

Cockerell’s remark will be familiar to anyone who has read or watched the existing accounts of EMS and its history, in which both narrators and interviewees

⁴⁶ Robert Moog, ‘Voltage Controlled Analog Devices’ *Journal of the Audio Engineering Society*, Vol. 13, No. 3 (July 1965), 200–206.

⁴⁷ Brian Hodgson, interview with author, 2016.

⁴⁸ Pinch and Trocco *Analog Days*, p. 357.

⁴⁹ James Gardner, ‘Interview – David Cockerell’, supplementary interview to *These Hopeful Machines* series. (Radio New Zealand, 2013.)

<https://www.rnz.co.nz/concert/programmes/hopefulmachines/audio/201812323/interview-david-cockerell>

often espouse a similar view of the synthesizer business, which its founders maintain was devised solely through the need to have ‘something to sell’.⁵⁰ In Mark Bate’s 2006 film *What the Future Sounded Like*, Cockerell says, ‘The whole purpose of EMS was to pay for Peter’s studio...by making miniature versions of things he had in his studio, that could be sold’.⁵¹ Zinovieff has corroborated this in numerous interviews, but in the frank conclusion to Bate’s film, he reveals his disappointment in the way EMS became perceived: ‘It seems rather a shame that we were foremost in the world [as a computer music studio], but in the end became famous for rather pathetic little synthesizers’.⁵²

This is not just a line that has emerged in the last decade or so, as the company’s directors have been prompted to look back at and reassess their achievements. In 1977, Zinovieff told Norma Beecroft, ‘The main purpose of making synthesizers is to finance the people who work in the studio, and finance the studio to get new equipment’⁵³ and in 1979, Michael Rodd, the presenter of the BBC film *The New Sound of Music*, remarked – over footage of Zinovieff’s studio, which had by then relocated from London to Oxfordshire – ‘[Zinovieff’s] synthesizers have brought him commercial success, although he would probably prefer the musical success so far largely denied him’, a sentiment that one suspects came from Zinovieff himself.⁵⁴ It should be remembered that these 1970s discussions took place against a backdrop of Zinovieff’s attempts to sell, then donate his studio to the nation as a public resource. With this in mind it made sense for Zinovieff to present EMS London Ltd in an almost philanthropic light, as music critic Hugo Cole reported in the *Guardian* in 1973:

Where EMS is unlike other businesses is in its use of profits – all are put back into the studio, to finance further development, and to provide serious composers with equipment which they can find nowhere else in the world.⁵⁵

⁵⁰ Zinovieff quoted in Chadabe, p. 150; see also Pinch and Trocco, *Analog Days*.

⁵¹ *What the Future Sounded Like* (dir. Bate, 2006)

⁵² Ibid.

⁵³ Norma Beecroft, *Conversations with Post-World War II Pioneers of Electronic Music* (Toronto: Canadian Music Centre, 2016), p. 376.

⁵⁴ *The New Sound of Music*, BBC 2, 5 June 1979. The majority of the film is shot at the BBC Radiophonic Workshop, and features an EMS Vocoder, a Synthesi 100 and numerous VCS3s, thus proving the presenter’s point, on the one hand; yet on the other, it is never mentioned that all of these devices were made by Zinovieff’s company.

⁵⁵ Hugo Cole, ‘He doesn’t advance cautiously...’ [profile of Peter Zinovieff], *Guardian*, 15 January, 1973.

It is certainly the case that very different strands of activity took place across the various locations associated with EMS, and that these activities involved different priorities, participants and outcomes, some of which appear to be unrelated to others. However, given Cockerell's interesting description of the EMS synthesizers as 'miniatures' of the studio – in other words, replicating the technological and musical priorities of the studio – the attitudes expressed, particularly by Zinovieff, towards EMS products is worth noting. Pinch and Trocco have pointed to Zinovieff's class background and his subsequent detachment from the world of 'trade' as a reason for his lack of interest in and the eventual failure of EMS as a company.⁵⁶ But this explanation, while no doubt containing some truth, does not take into account firstly that Zinovieff pursued commercial success in other areas, such as the unsuccessful telecommunications project, VOCOM, with which he was preoccupied from 1973 to 1975; and secondly, that Cockerell, who worked far more closely with the commercial side of the company, shared Zinovieff's opinions of the synthesizers – which he had played an important role in designing – as limited in scope and value.

It is possible to read these criticisms of EMS products by their makers as indicative of other concerns circulating within both electronic music and in the wider culture: firstly, the 'limited' way in which synthesizers were perceived to be used in pop and commercial music (rather than synthesizers' commercial nature per se, although this was certainly an issue for some critics); and secondly, a widely held suspicion of the effects of technology on art that, as we have seen in the previous chapters, Zinovieff felt necessary to counter in his writing and in interviews; and thirdly, the negative, or at least cautious, view of synthesizers at this time from more seasoned practitioners of electronic music, who criticized their lack of sophistication and the tendency to reduce, rather than expand, sonic horizons.

For example, much has been made of Delia Derbyshire's response to the arrival of synthesizers at the BBC Radiophonic Workshop, which is said to have led to her departure.⁵⁷ This is likely to have been overstated in narratives about Derbyshire's career at the BBC, but it is confirmed to some extent by Louis Niebur in his account of the Radiophonic Workshop where he states that, although she enjoyed using the

⁵⁶ Pinch and Trocco, *Analog Days*, p. 289.

⁵⁷ For an examination of some of the stories about Derbyshire and synthesizers circulated in the popular music and music technology press, see Frances Morgan, 'Delian Modes: Listening for Delia Derbyshire in Histories of Electronic Dance Music', *Dancecult*, 9, 1 (2017).

VCS3, when it came to the BBC's Synthesizer 100, or 'Delaware', as it was known, Derbyshire preferred the 'more abstract options offered by traditional tape techniques'.⁵⁸ Time might have been saved, processes might have been rationalised but creativity was to some extent curtailed, not least because the synthesizer made it easier for composers to 'realise "normal" tunes *electronically*' rather than experimenting with concrete sound and unusual tonalities, as Derbyshire had done previously to great effect using tape.⁵⁹

This discomfort with the synthesizer brings to mind the concerns about the 'totalising' technological device that Jacques Ellul raised in *The Technological Society*, which was first published in English in 1964 and portrays technology as a force moving inexorably towards its goal of maximum efficiency, disregarding 'nature' and human instinct as it does so.⁶⁰ We might also remember the metaphors of industry and manufacturing which were used to describe computer-generated music in the previous chapter, or think of the worries of the Musicians' Union, for whom advancements in audio technology often came at the expense of performing musicians. In the early 1970s, synthesizers were too much of a minority concern in the UK to upset the Union, but a decade later it would raise concerns that synthesizers were reducing job opportunities for instrumentalists.⁶¹

Wendy Carlos, surveying the state of the American synthesizer market for *Whole Earth Catalog* in 1971, wrote,

Sure, the pianola is lots of fun at the right party, but Nancarrow notwithstanding, it might be healthier if we had a little less, not more activity in E.M. [Electronic Music], at least for a period long enough to let the smoke screens either vaporize or settle down into a uniform dust film over all of musicland, ecology be damned!⁶²

⁵⁸ Niebur, *Special Sound*, pp. 140-41. Of the impact of voltage controlled synthesizers on studios, Peter Manning notes that, 'it would be erroneous ... to suggest that ... the compositional philosophies built up around the more traditional technology of the 1950s became irrelevant in the new era of studio design'; however, he gives as examples more 'classical' studios, which were not driven by the same commercial and time pressures of the BBC. Manning, *Electronic and Computer Music*, pp. 143-4.

⁵⁹ Niebur, p. 124; author's emphasis.

⁶⁰ Jacques Ellul, *The Technological Society*, translated from French by John Wilkinson (New York: Vintage Books, 1964).

⁶¹ John Williamson and Martin Cloonan, *Players' Work Time: A history of the British Musicians' Union, 1893-2013* (Manchester: Manchester University Press, 2016).

⁶² Wendy Carlos, 'Walter Carlos on synthesizers', *The Last Whole Earth Catalog*, June 1971, p. 330.

For Carlos, who had worked with Robert Moog since the mid-1960s and been one of the first players of Moog's synthesizers, the arrival of these portable machines with their promise of instant electronic music was to be viewed with suspicion. In its new, simpler form – especially with a keyboard attached – the synthesizer looked as if it would be easy to play, but Carlos cautioned the readers of the *Whole Earth Catalog* that the most important ingredients of electronic music were not just the instrument itself but 'time and bread': in other words, the electronic musician needed the finances to kit herself out with tape recorders and other peripheral devices, and then enough time to learn how it all worked, in order to 'enable any music to come out of these "instruments"'.⁶³ In the same article Carlos gave the EMS VCS3, described by its US name, the Putney, a critical review, describing it as 'a real toy'. She commented,

Its components are highly unstable/unpredictable, and the selection made is highly gimmick oriented, and does not by any stretch of the mind permit any subtle sounds to be constructed. It also has a so-called touch-sensitive keyboard [the DK1] which has to be tried to be believed, it's that awful! ... But it is small & portable & groups might like it for special effects.⁶⁴

In the hands of the 'wrong' musicians – in this case, the casual, novelty-seeking, unprofessional musician, perhaps even the musician who had sought out a Moog synthesizer after hearing Carlos's 1968 album *Switched-On Bach*⁶⁵ – would the results of this 'unstable/ unpredictable' device be an unstable, unpredictable music?

Alongside the concern that the synthesizer overly rationalized electronic music was another worry: that it would produce, simply, 'bad' music. Hugh Davies, another early adopter of electronic techniques, remarked in 1977 that the VCS3 'has to be used with a great deal of care and discretion, and control, which a lot of people don't apply to it'.⁶⁶ Yet Davies had also constructed radically unconventional electronic instruments that could be used by musicians of varying experiences and proficiency; so again, the question arises: what would be the worst outcome of not handling this new instrument with care and discretion, and why was this warning applied to it?

As Théberge, Waksman, and others have pointed out, an instrument maker has little control over the public identity of their device, which emerges only fully in its

⁶³ Ibid, quote marks Carlos's own.

⁶⁴ Ibid, quote marks Carlos's own.

⁶⁵ Wendy Carlos, *Switched-On Bach* (Columbia Masterworks, 1968).

⁶⁶ Beecroft, p. 343.

use.⁶⁷ This observation has been developed further by critical organology scholars such as Maria Sonevtsky, who notes that ‘a musician’s “engagement” with an instrument includes the negotiation of various stereotypes associated with the instrument’.⁶⁸ While EMS’s founders might not have wanted to be associated with pop musicians, the company nonetheless created an instrument that, given the take-up of the VCS3 by pop and rock artists, seemed to be attractive to and within the financial reach of a successful pop group, record label or independent recording studio, during a period in which popular music was a thriving industry. Unlike their American competitors, EMS did not start by building a large system, such as the early Moogs or the ARP 2500 and 2600 models, which would then be streamlined into smaller ones. They began, instead, by thinking about what an entry-level electronic instrument for an interested but inexperienced musician could be like. For all their intentions, they were at least partially responsible for the way in which the voltage-controlled synthesizer, as Manning rather loftily puts it, led to ‘artistic trends that were not wholly advantageous to the artistic development of the medium as a whole’.⁶⁹

Electronic music’s position within models of high and popular culture in the postwar period is a subject worthy of an entire study, and indeed it is the central argument of Brend’s *The Sound of Tomorrow*, with its subtitle *How Electronic Music Was Smuggled into the Mainstream*.⁷⁰ Instead of surveying EMS in relation to the high/popular culture binary, I want to briefly introduce an area of cultural activity that EMS did not either target or disavow, partly because, I argue, the accessibility of electronic music-making made possible by EMS’s instruments actually contributed to its formation.

As I noted in Chapter One, an emerging experimental music culture, as defined by Michael Nyman and, later, Benjamin Piekut, included electronic music alongside and sometimes combined with free improvisation, flexibly scored music, Fluxus-inspired performance, jazz and other musical and artistic forms.⁷¹ Two live electronic groups

⁶⁷ Théberge, *Any Sound You Can Imagine*; see also Steven Waksman, ‘Reading the Instrument: An Introduction’, *Popular Music and Society* 26: 3 (2003), pp. 251-61.

⁶⁸ Maria Sonevtsky, ‘The Accordion and Ethnic Whiteness: Toward a New Critical Organology’, *The World of Music*, 50, 3 (2008), pp. 101-118 (p. 103).

⁶⁹ Manning, p. 143.

⁷¹ Benjamin Piekut, ‘Indeterminacy, Free Improvisation and the Mixed Avant-garde: Experimental Music in London: 1965–75’, *Journal of the American Musicological Society*, 67: 3 (2014), 769–824.

were connected with what Piekut has called the ‘mixed avant-garde’,⁷² Gentle Fire, formed by Hugh Davies, and Intermodulation, a quartet whose members, by 1971 or 2, all used VCS3 synthesizers. Both groups combined acoustic instruments and, in the case of Gentle Fire, amplified objects, with electronic instruments; and in Intermodulation, the VCS3 was frequently used as a signal processor for the group’s string and reed instruments.⁷³ Writing in *The Observer* in 1969, Intermodulation’s Tim Souster celebrated the new musical connections that, to quote the headline of his piece, were breaking ‘through the sound barrier’. Piekut writes,

For Souster, the overlaps of the late 1960s differed profoundly from earlier efforts like that ‘most miserable’ example, third-stream jazz. He credited ‘a general creative atmosphere in which numerous factors – electronics, the emphasis on performance and on sheer sound and the idea of music-making as a social activity – are common to ‘pop’ and ‘serious’ music’.⁷⁴

However, what now constituted ‘pop’ was, in this new musical climate, also up for debate. An indication of how Intermodulation saw the group in relation to current musical genres and audiences can be seen in a note from another of its members, Roger Smalley, to the group’s manager Ernest Chapman about how Chapman should describe Intermodulation in the press releases he was writing for them. Chapman had suggested citing Wendy Carlos’s *Switched-On Bach* as a reference point for the public. Smalley replied,

All unanimously agree that we don’t want to be associated in any way with the Moog Bach record! If you want to mention good record sales, why not use *A Rainbow in Curved Air* (Terry Riley)... or the DGG [Deutsche Grammophon] *Avant Garde* sets.⁷⁵

At that time, Chapman was also the general administrator of the Macnaghten concerts, a long-running series of contemporary chamber music events in London. His

⁷² Piekut, p. 769.

⁷³ Simon Emmerson, ‘Live Electronic Music in Britain: Three Case Studies’, *Contemporary Music Review* 6: 1 (1991), 179–195.

⁷⁴ Piekut, pp. 772–3.

⁷⁵ Roger Smalley to Ernest Chapman 1970, Intermodulation Archive, British Library.

communications with the members of Intermodulation show that he was not quite familiar with the reference points of the group and the world they moved in, which overlapped with the Macnaghten milieu to some extent but also included Cornelius Cardew's Scratch Orchestra and the improvising group AMM. Although all of Intermodulation's members were classically trained composers and instrumentalists, they nonetheless understood that there was common ground between minimalist composers such as Terry Riley and a growing experimental rock subculture, based on shared influences from electronic, improvised and traditional musics – and that this subculture had contributed to the success of *A Rainbow in Curved Air*, which had, through its popularity, attained the status of a pop record. Here, Smalley was identifying an audience that was more discerning, less 'pop', than the people who had bought *Switched-On Bach*, with its familiar tunes and mass appeal, yet were also unlikely to attend the concerts that generally comprised Macnaghten programmes.

Piekut locates the practice of improvisation as the nexus of the 'mixed avant-garde'; but to this I would add ideas from electronic music such as modularity, indeterminacy, programmed repetition, unusual timbres and microtonality. All of these could be articulated through the VCS3, but also through a score or a set of performance directions, and through a kind of thinking about musical experience and presentation. In creating a synthesizer with which musicians could explore these ideas with relative ease, the founders of EMS furthered the dialogue between various experimental music cultures and made live electronic music a real possibility for new groups such as Intermodulation and Gentle Fire.

We can see from these examples that the promise of the synthesizer – that it would provide efficient control of a complex process to a greater number of people – was also what threatened to produce both carelessly chaotic *and* bland, uniform music, in allowing people to access and exercise technology who had not thoroughly learned how to operate it in the 'correct' way. If a common criticism of electronic music was that it required little time, effort or instrumental expertise on behalf of the composer or performer, the synthesizer might seem to confirm this, in making it easier to abdicate musical decision-making to a machine in the knowledge that a novel, surprising sound would be produced, if nothing else. Yet the relative accessibility of the synthesizer also helped to create a culture of electronic music in which experiments could be carried out live, in an ensemble, and in front of audiences, thus proposing a new social dimension for electronic music, as well as a form of 'liveness' that was ontologically

different from what ‘live electronic music’ had meant before; that is, tape playback of a previously composed electronic piece.⁷⁶ The VCS3’s accessibility, thought of in this way, could lead to the production of more original music rather than less.

The computing and synthesizer manufacturing activities of EMS both sprang from a desire to help composers realize sonically and structurally complex ideas through electronic means. Both the synthesizer and MUSYS did this, but to different extents, using different tools and with different degrees of precision.⁷⁷ Over time, the fact of the success of EMS synthesizers and the decline of the studio has become laden with ideas about analogue and digital technology, cultural and class differences, and technological progress and stasis. However, there is a case for considering the two strands of EMS’s activities as complementary rather than opposed, in much the same way as the studio combined different technologies to create a hybrid system. The Synthi 100 synthesizer, as a voltage-controlled synthesizer with a built-in digital sequencer, represents more than any of the company’s other instruments the hybrid approach and creative philosophy of the EMS studio.

4.5 Creating time: the Synthi 100

The designer of a synthesizer [...] can aim to make the instrument reasonably easy to use by reducing the number of decisions to be made by the user. This means fitting switches or permanent connections between various components in order to reduce the size of the patch [...] The trouble is that the final decisions reflect what the designer would like, but not necessarily what you would like. Alternatively he can design a ‘no compromise’ instrument in which every decision has to be made by the user and a virtually limitless number of connections are possible. Such machines are not easy to use well, and the larger the machine the more difficult it becomes, but we make no apology for following this second course when we designed the Synthi 100.⁷⁸

Like the VCS3, the impetus for this new, ‘no compromise’ synthesizer came from outside EMS, but in this instance the commission came not from an individual

⁷⁶ see Stephen Davies, *Musical Works and Performances*; and Chapter One.

⁷⁷ As Douglas Kieslar notes, ‘The software engineer who develops sound synthesis tools can be considered an abstraction of the traditional instrument builder’. Kieslar, ‘A historical view of computer music technology’. In *The Oxford handbook of computer music*, ed. by R. Dean (Oxford: Oxford University Press), p. 25.

⁷⁸ EMS, *Synthi 100 manual*, (c.1974).

composer but from an institution: Radio Belgrade, where a new electronic music studio was being planned. However, Peter Zinovieff soon surmised that other institutional studios might be interested in a similar machine and, before the Belgrade synthesizer was finished, a synthesizer called the ‘Delaware’, built to the same specifications, had been installed at the BBC Radiophonic Workshop in 1971, while another model was made for the University of Cardiff’s Electronic Music Studio, which was founded in 1971 by Keith Winter – a supporter of BSEM and a former music officer at the Arts Council.⁷⁹ Chapters Five and Six tell the story of the Synthi 100 at the BBC and in Belgrade; in this section, I discuss some aspects of its make-up and describe its use by the composer Malcolm Clarke in relation to an idea of ‘time-creating’ media.

Once the generic name Synthi 100 had been decided upon, EMS began marketing their new invention to those seeking to make ‘really exacting composition and realization work in professional and electronic music studios, broadcasting companies and universities’, as a marketing brochure put it.⁸⁰ In this brochure, a full-page photograph of the Synthi 100 shows a large, imposing device, the antithesis of the portable VCS3 and Synthi A models, next to a shelf unit housing boxes of tapes, and with what looks like a graphic score open on the leather-covered desk area between the two patch matrices. A two-tiered keyboard – the controller for the Synthi 100’s sequencer – is in the foreground (see Fig. 4.5). The visual representation emphasizes the professional aura of the instrument, which is, in fact, advertised here not as an instrument at all, but a ‘professional music studio’. If the VCS3 aimed to represent a studio in miniature, it was also very much a portable, playable instrument that could adapt to a number of environments; in contrast, the Synthi 100 was an environment in itself. Its sheer size – around six feet long and five feet high, with a depth of over three feet – meant that it could not help but be the central feature in any studio in which it was installed. Its immovability was in some cases quite literal: accounts of doors being widened and windows removed, and tales of precarious lifting operations, come up in

⁷⁹ Situated in the Physics department of the university, the Cardiff studio was unusual in also including two PDP-8 computers, in a similar set-up to EMS’s original studio configuration. Keith Winter, ‘Electronic Music Studios in Britain 2: University College, Cardiff’, *Contact* 19 (1976), p. 31.

⁸⁰ EMS, Synthi 100 marketing brochure (c.1972).

numerous accounts of the Synthi's installation in the institutions to which it was sold, including Belgrade, Ghent and Cardiff.⁸¹

The Synthi 100 takes the basic model of the VCS3 and expands it, with twelve oscillators to the VCS3's three, and three envelope shapers, noise generators, voltage-controlled filters and ring modulators to the VCS3's one, and so on, with all the added combinatory and control possibilities this suggests. The distinctive EMS pin matrix was expanded into two separate matrices, each 60 by 60: the right for input signals and the left for voltage control. The controls for the sequencer were on the furthest panel to the right, with two five-octave keyboards acting as its interface: rather than being built into the synthesizer, they were separate devices that could be moved to wherever the composer needed, or indeed not used at all, if the Synthi was being used solely as a sound generator: as with EMS's other instruments the keyboard was intended as a device for inputting data, rather than musical expression.

The Synthi 100's 256-step digital sequencer was also developed and eventually made available as a separate device – the EMS Sequencer 256 – and marketed as an add-on for the VCS3 or Synthi A. Building a sequencer into the Synthi 100 brought the two technologies together, with the intention of helping the user make sense of the 'virtually limitless' possibilities of the synthesizer by storing the complex patches they were likely to come up with, given the vastly increased options. The Synthi 100 manual describes the sequencer as an assistant: 'the most helpful aid to a synthesizer user ever invented'. It continues, 'Short of full-scale computer control (which is also possible, of course) there is no method of storing voltages which is so accurate and flexible'.⁸²

Using the keyboard, the composer could record a sequence of control voltages to the sequencer's digital memory: these could, of course, be melodies, but it was also possible to use the stored frequency voltages to map to other control voltages across the synthesizer, so that pitches could become white noise, or a pattern of notes could be sent to an envelope filter, giving it attack, decay, and so on. These adjustments could be made in real time, while the sequencer was playing back whatever had been recorded to it. Significantly, the sequencer made it possible to manipulate not only timbre and tone but also qualities such as duration, speed and amplitude with a degree

⁸¹ Interviews with Paul Pignon (2017), Brian Hodgson (2016) and Ivan Scheppers (2016); see also Stephen Howell, 'Cardiff University Electronic Music Studio', *Electronics & Music Maker*, April 1982.

⁸² EMS, Synthi 100 manual, (c.1974).

of accuracy that was hard to achieve by other means. Voltages could be stored on three ‘layers’ or channels, all of which could be set to interact with one another. While the sequencer was one of the most important aspects of the Synthi 100 from its makers’ point of view, it was not always reliable or even functional: in some studios it was barely used at all. The gap between the aim of the Synthi 100 – to create an ideal, ‘no compromise’ studio solution – and the reality – an unwieldy, sometimes unreliable device that in many cases was thought to have had outlived its usefulness by the early 1980s – will be explored in the following chapter. However, by staying for now with the ideal scenario portrayed in its manuals and advertising copy, we can try to understand what EMS hoped to achieve with the Synthi 100.

As we have seen in the previous chapters, the aim of sequencing musical information drove the earliest experiments that were carried out at Zinovieff’s studios; and as we know from Chapter Three, the goal of the studio was to do this digitally. The Synthi 100’s sequencer did not provide ‘full computer control’, but it could introduce the concept of digitally storing and reproducing sound to musicians who, at least in the early 1970s, would be unlikely to have encountered it through a computer.

In *The New Sound of Music*, the 1979 BBC documentary mentioned earlier in this chapter, the BBC Radiophonic Workshop’s Malcolm Clarke demonstrates how, after recording a sequence of notes on the Synthi 100, ‘my hands are now free to concentrate on the sound quality’. He stresses that the control voltages – which we hear as pitches – have been recorded ‘not on a tape, but into a memory system’. It is hard to say what this distinction, articulated in such a way, meant to most viewers of the programme, as they watched how the Clarke played, edited, looped and then transformed, using the controls of the synthesizer, a simple melody into an almost unrecognisable pattern of ambiguously pitched sounds. But what Clarke was demonstrating was that the Synthi 100, with its sequencer and voltage-controlled synthesizer, not only ‘saved’ time in the sense that it appeared to speed up a recognizable creative process of making, recording and manipulating sounds, but created a new timeframe altogether: the ‘chrono-technical’ effect, as Wolfgang Ernst expresses it, of ‘real time’, a timeframe governed by the clock of the sequencer that ‘exceeds the human time window’.⁸³ Here, Clarke’s melody seemed to be infinitely

⁸³ Wolfgang Ernst, *Chronopoetics: The Temporal Being and Operativity of Technological Media*. Translated from German by A. Enns (London: Rowman & Littlefield, 2016), p. 66.

malleable yet also fixed in the sequencer's memory as a system of values to which one could return, reconfigure and start the process again.

The sequence that Clarke makes in this demonstration is one that he had come up a few years earlier for what he describes in *The New Sound of Music* as a 'science fantasy play about a house that is completely automatic'. This refers to an adaptation of Ray Bradbury's short story *There Will Come Soft Rains* (1950) which was broadcast on BBC Radio 4 in 1977.⁸⁴ In the story, the house, which has been programmed to carry out functions such as cooking, cleaning (using robotic mice, whose signature sound is the one that Clarke demonstrates in *The New Sound of Music*), watering the garden and so on, even though the family has been destroyed by a nuclear blast. A central sonic figure of the story is the clock to which the house's schedule is set, which 'ticks on, repeating its sound into emptiness', while 'somewhere in the walls, computer tapes are gliding under electronic eyes'.⁸⁵ It is, of course, only in retrospect that the use of new time-producing technologies to illustrate this dystopian story about an automated device that outlives its human users seems significant: at this point, Clarke had been using the Synthi 100 for around six years, producing music and sound effects for *Doctor Who* and many other programmes, and it was unlikely that he would have used any other instrument for this project. However, the Synthi 100's demonstration of the malleability of time and memory in the sound design of *There Will Come Soft Rains* forms an interesting counterpoint to the absurd inflexibility of Bradbury's 'automatic' house. The playfulness of the soundtrack does not disparage Bradbury's postwar anxieties about the twin threats of nuclear war and a computerized society, but perhaps it articulates another, newer approach to technology in which the user retains creative agency, even – especially – when using automated processes. Rather than exerting temporal control over all aspects of human activity, like the clock to which the house in the story is enslaved, the new analogue-digital synthesizer could produce multiple musical temporalities for the composer to explore.

The ideal Synthi 100 user envisaged by EMS was a composer able to commit a significant amount of time to the instrument and become deeply absorbed in its seemingly endless possibilities; which is to say, a composer with access to the kind of

⁸⁴ August 2026: *There Will Come Soft Rains*. Malcolm Clarke (Composer), Ray Bradbury (Writer). UK: BBC Radio 4, 11 May, 1977.

⁸⁵ Ray Bradbury, 'There Will Come Soft Rains', *The Martian Chronicles* (New York: Doubleday, 1950).

well-equipped, professionally run studio environment that the smaller, cheaper synthesizers produced by EMS seemed to suggest was not the only space in which one could make electronic music. In contrast, with a starting price of around £6500 (in 1971 – the equivalent of around £50,000 in 2017), the Synthi 100 was unlikely to be sold to any private individuals without a large institutional budget.⁸⁶

In early marketing material for the Synthi 100, we find EMS offering to equip a fully computerized studio – with a photograph of the one at Putney for reference – to clients in such institutions wishing to expand on the possibilities of the Synthi. The company offered to install, along with the Synthi 100, ‘a set of digital to analogue (DAC) and analogue to digital (ADC) converters; a crystal clock; and a computer system’;⁸⁷ this, they specified, would be a PDP-8, similar to those in the Putney studio, which would run the MUSYS program. This offer was not taken up by any studios in this exact form, but in 1975, Zinovieff devised a computer interface for the Synthi 100, which he attempted, unsuccessfully, to sell to the BBC Radiophonic Workshop.⁸⁸ This became the Computer Synthi, of which three were produced before the closure of EMS in 1978, one going to Glasgow University,⁸⁹ one to film composer Michael Fano,⁹⁰ and the last being installed in Zinovieff’s own studio in Great Milton, where EMS moved its operations after the sale of the house in Deodar Road.

Bearing in mind Zinovieff and Cockerell’s advanced knowledge of the pace of technological change, the proposals that EMS made to professional and academic electronic music studios do not seem to have quite taken into account the economic implications of how these studios were likely to change rapidly with the introduction of new digital music technologies. In 1983, the Director of the University of East Anglia studio, Denis Smalley, making an internal funding bid to buy new equipment, wrote, ‘Ten years ago the Synthi 100 was regarded as a technological highpoint, but now because of the developments in digital technology which have initiated radical musical change, it is an inadequate museum piece.’ As to its worth as an investment,

⁸⁶ Bruno Spoerri was the only composer to buy a Synthi 100 for a private studio in the 1970s (source: Synthi 100 customers spreadsheet, Robin Wood).

⁸⁷ MS/2160: Promotional and Marketing Material, Alan Sutcliffe Archive, Science Museum.

⁸⁸ Peter Zinovieff to Desmond Briscoe, 25 March 1975. BBC Written Archives R97/10/3: Radiophonic Technical committee 1972–75.

⁸⁹ Stephen Arnold, *Electronic Music Studios in Britain - 9: University of Glasgow* in *Contact* 19 (Summer 1978), p. 20.

⁹⁰ *Ibid*; Robin Wood, interview with author 2018.

he noted that, unfortunately, the synthesizer ‘has no significant resale value because of its obsolescence’.⁹¹

Yet during the 1970s, the complexity and the vast range of possibilities promised by the Synthi 100 encouraged a deep engagement from composers, and, significantly, from engineers and studio directors, who were likely to have had the most in-depth knowledge of the machine and who were responsible for helping composers to use it. The Synthi 100’s position within the wider context of electronic music studio cultures will be examined in Chapters Five and Six.

4.6 Conclusion

In the late 1960s EMS took note of the new voltage-controlled synthesizers that were being developed in the US by Moog and Buchla, and created the first European range of synthesizers. These appeared at a time when electronic music, while still a minority interest, was becoming more familiar to listeners of popular, commercial and concert music; subsequently, as the synthesizer became understood as an instrument, it helped to create a visual identity for electronic music, which was further established in the marketing of early synthesizers in the audio-technical and music press. A number of ideas were placed onto the synthesizer, from commonly held notions about the implications of automation and time- and labour-saving devices, to discussions around popular, classical and ‘experimental’ music cultures. These ideas formed part of a discourse around the synthesizer which was taken part in by its manufacturers, advertisers, users and critics.

The sketch I have given of the VCS3 shows that it established EMS as a composer-led maker of original instruments that, in the UK, was the market leader in an admittedly small field. The VCS3 brought the name, sound and design principles of EMS into numerous schools and colleges, and played an important role in the experimental live electronic music culture of the late 1960s and early 70s, as well as in rock and commercial music. The Synthi 100 took the focus back to the studio, offering a kind of EMS in microcosm that would encourage users to aim towards computer-controlled music in the future.

⁹¹ Cited in Simon Waters, ‘Sound Structures, Social Structures, Technical Structures: Changing Practices and Behaviours in a UK University Studio 1973-2008’. Paper given at Electroacoustic Music Studies Network International Conference (Paris, 2008).

In this chapter I have introduced some of the themes that inform how I present the Synthi 100 in the next chapter, focusing on its users, the studios in which it was installed, and its potential for creating, manipulating and otherwise affecting musical time, through a perspective informed by media archaeology. In the following two chapters, through case studies of the BBC Radiophonic Workshop and Radio Belgrade Electronic Studio, I reflect upon how the Synthi 100's production and manipulation of time can be thought about within other timeframes, including the idea of 'studio time'. This meant different things in the deadline-driven BBC Radiophonic Workshop; and in the more expansive environment of Radio Belgrade, in which there was space to explore the most sophisticated functions of the Synthi 100 over a period lasting more than a decade. In constructing narratives of these experiences through interviews, recordings and archival documents, I show how the Synthi 100 impacted upon electronic music studio culture in the 1970s.

PROJECT/NAME/DATE VCS3 USERS MANUAL SECTION VII	SHEET No :
PERFORMANCE / RECORDING NOTES	PATCH No : 4
"Bowing" the Ring Modulator	SETTING No :
	START TIME :
	END TIME :
	PERIPHERALS
Note: Controls 1 & 9 - Tune for concord such as sixth.	
	NONE

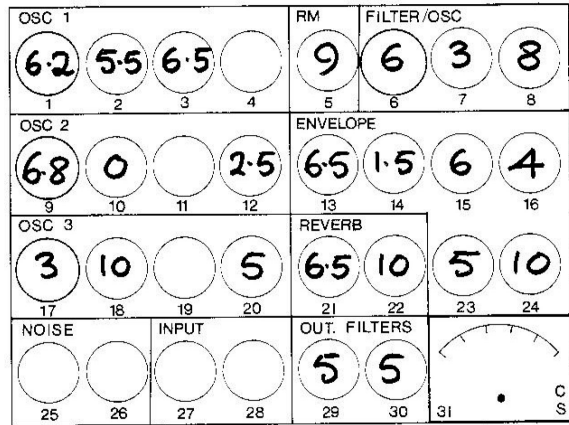

NUMBERS ARE DOPE SHEET REFERENCES, NOT PIN BOARD NUMBERS

SIGNALS CONTROLS

	OUT AMPS		RING MOD		FILTER		OSC. FREQ			OUT AMPS		1 2
	1	2	A	B	1	2	1	2	3	1	2	
OSC 1												1
OSC 2												2
OSC 3												3
NOISE												4
INPUT 1												5
AMPS 2												6
FILTER												7
TRAPEZ												8
ENV SIG												9
RING MOD												10
REVERB												11
STICK												12

CONTROL CHANGES
1-8
9-16
17-24
25-31
32-39

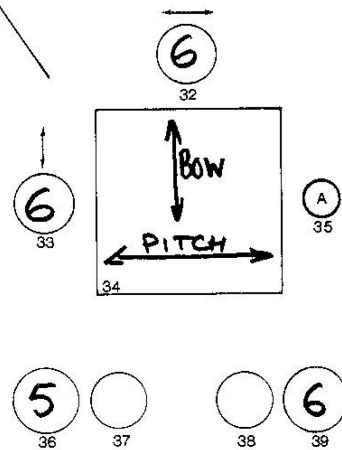

Prices

ELECTRONIC MUSIC SYNTHESIZERS

†Synthi VCS 3 (tuned up version only)	£350.00
†Synthi KB1 (Available May 1971)	£330.00
†Synthi A	£198.00
Synthi DK1 (with dynamic control)	£150.00
Synthi DK1 (without dynamic control)	£100.00
Synthi 100	£6,500.00

DIGITAL SEQUENCERS

*Synthi Sequencer (to be used in conjunction with Synthi DK1 Keyboard. 2 tracks, no editing)	£135.00
*Synthi Moog Sequencer (for connection to Moog synthesizer. Six tracks, full editing, including Keyboards)	£1,100.00

ELECTRONIC MUSIC PERIPHERALS

*EMS Octave Filter Bank	£80.00
*EMS Pitch to Voltage Converter	£70.00

SPARES, ETC.

Special high stability pins for oscillators	35p each
Ordinary resistor pins	23p each
Handbook	£1.05 each
Dope Sheets	53p per pad
Synthi VCS 3 printed circuit boards	£50.00 each
Service charge to tune previously purchased Synthi VCS 3, as described above	£20.00

†Complete with cover, plugs, mains control and handbook.

*Provisional prices.

ELECTRONIC MUSIC STUDIOS (London) LTD
49 DEODAR ROAD
LONDON
SW15
Telephone : 01-874 2363

**think of a sound...
now make it.**

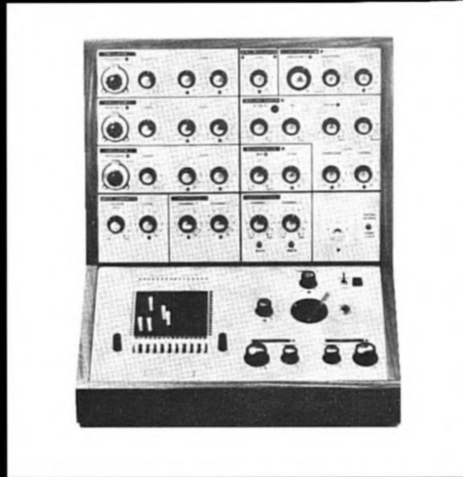

VCS3

Designed for the exacting standards of electronic music, the VCS 3 is also ideal for a general purpose audio test instrument and for teaching and demonstrating all aspects of sound phenomena. Why pay for elaborate and expensive laboratory instruments when for only £330 you can make any audio signal from pulse trains to sine waves, and process it from filtering to modulation or reverberation.

Everything is voltage controlled, with extremely good signal to noise ratio and high stability. There are three multiwaveform oscillators (.05 Hz - 20 KHz) single sweep of 1000 : 1, three filters, a ring modulator, noise generator, scope output and trigger input, a joystick control for any two parameters, cordless pin patching, and many more facilities.

No studio musician, whether technician, teacher, composer, performer or engineer, can afford to be without this amazing instrument, with its tremendous variety of sound effects, and which is a direct spin-off from the most advanced computerised music studio in the world.



Write or phone for details and free brochure to :
ELECTRONIC MUSIC STUDIOS (London) LTD
49 DEODAR ROAD
LONDON S.W.15
Telephone : 01-874 2363



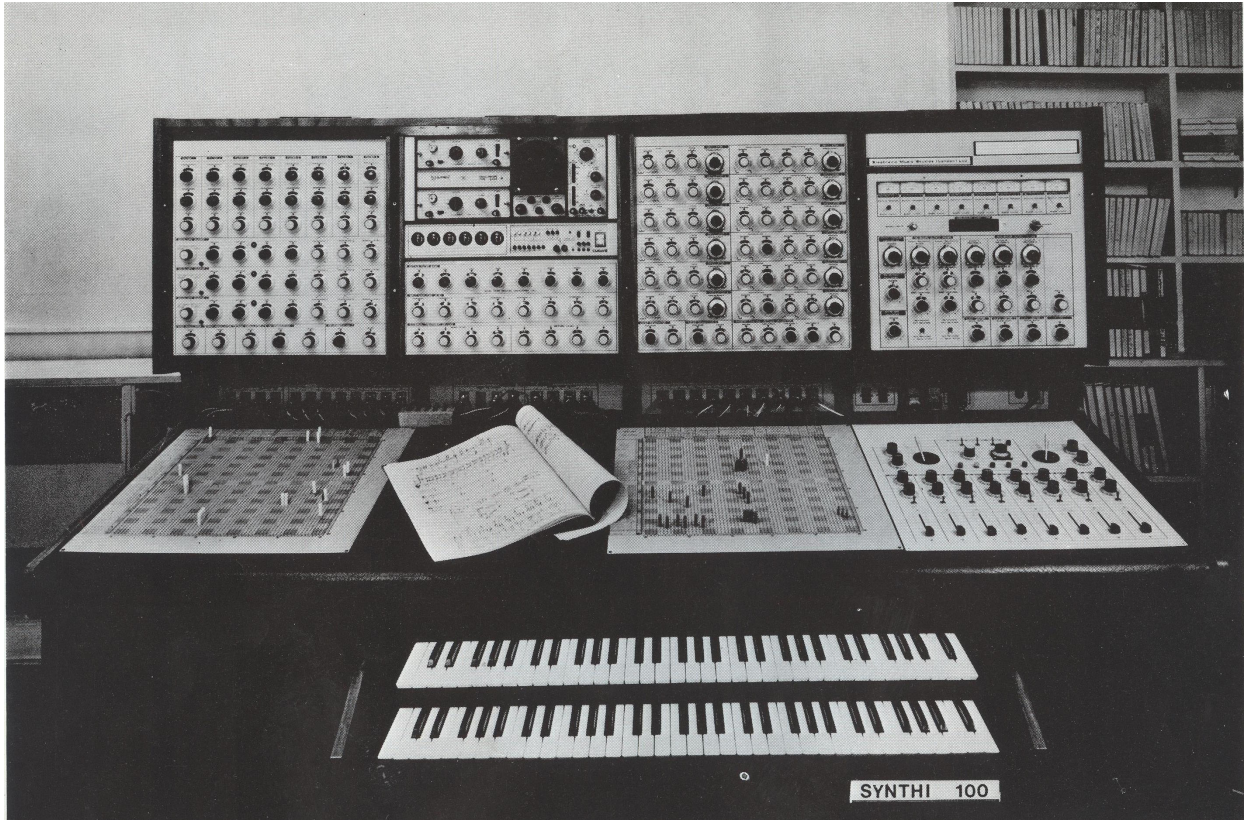

Chapter 5

‘A roomful of instruments’: the Synthi 100 at the BBC

5.1 Introduction

In this chapter and the next, I examine how the Synthi 100 was used in two different studio environments, in London at the BBC Radiophonic Workshop and in Radio Belgrade’s Electronic Studio. The BBC Radiophonic Workshop was the first recipient of a finished Synthi 100, which was known as the ‘Delaware’ (the name of the road on which the Workshop was situated). This chapter details the processes behind its acquisition and examines some instances of its use at the Workshop. Throughout the chapter, I focus on the role played by studio manager Brian Hodgson in acquiring and using the Delaware, and consider how his relationship with the instrument played out over the course of the 1970s, during which time he left the BBC, set up his own studio, and then returned to the Radiophonic Workshop at the end of the decade as its Organiser.

The Synthi 100 was marketed towards new electronic music studios that were being set up during the 1970s, as we have seen in Chapter Four. These included broadcasting studios such as the BBC, whose electronic music facilities had been established in the late 1950s but who were now looking update their studios with the new, voltage-controlled synthesizers that were being introduced by companies such as Moog, ARP and EMS. Although it was cheaper in price than the comparable large systems made by Moog and ARP (such as the Moog 900 Series and ARP 2600), the Synthi 100 would never have been expected to be produced in large numbers. However, with only thirty models made by EMS, and one by Datanomics, the company that bought EMS after the company’s closure in 1979, it is fair to ask why one would focus on an instrument that was accessible to so few people, and that was manufactured, sold and used, for the most part, within a timeframe of less than ten years. Why not the more popular, versatile and well-travelled VCS3? In focusing on the Synthi 100 in this way, I am narrowing the field from the expansive possibilities of the portable synthesizer and into an institutional studio setting. However, this is deliberate. As I proposed in Chapter Four, focusing on the Synthi 100 helps us to think

about EMS not just as a company or as a studio but more generally, as a set of creative and technological concerns, because it reflects the preoccupations with sonic complexity, digital control of musical sequences, and the potential for generative composition that also animated the research and composition being done in Peter Zinovieff's studio. Additionally, because the institutional electronic music studio of the 1960s and 70s is the one of the main musical-historical contexts in which this study is situated, analysing the Synthi 100's situation in and relationship with such studios connects my research with the wider network of studio ethnographies surveyed in Chapter One, in asking how a studio takes shape around the presence of one particular instrument. In its complexity and characterisation as a studio as well as an instrument, as it was often described, the Synthi 100 prompts questions – similar those about instrumentality that were considered in Chapter Four – about what is meant by the term 'studio', serving as a reminder that, as well as a physically located environment in which social and creative interactions occur, it can also describe a set of musical-technological processes carried out within one machine.

The Synthi 100's fixed position within studios did not guarantee its stability or longevity. The synthesizer defined and dominated the studios in which it was installed, yet this physical inflexibility made it vulnerable, its fortunes linked to that of the institution that housed it. As we saw in Chapter Four, it could not be easily adapted to fluctuations in funding or space allocation, or varying annual budgets, or changed priorities within an institution; and if a studio closed down or was refitted, it could not easily be moved to another site, or taken with a composer or studio director to a new job. Although, as we will see in this chapter, it occasionally found its way onto concert stages, with varying results – and a number of its present-day users have presented it as a live performance instrument (as I describe in Chapter Seven) – the Synthi 100 tended to confine its original users within the physical limits dictated by the instrument's size and its installation in a discrete, often purpose-built space. At the same time, it offered those users – as the Synthi 100 manual put it – 'virtually limitless' options to create and design both sounds and musical structures. Recent reconstruction projects involving Synthi 100s have drawn upon this historical notion of the 'limitless', flexible and infinitely configurable instrument in order to create new performance practices with it, while also addressing the Synthi 100's status as an institutional heritage object, representative of particular musical-historical spaces as

well as an artefact that symbolizes or illustrates an important period of electronic music history.

5.2 The Synthi 100 as a boundary object

From this introduction we can see how the Synthi 100 might be thought of as what Susan Leigh Star and James R. Griesemer first defined in 1989 as a ‘boundary object’; this notion, from sociology of science, can be useful in studies of not only material objects but ensembles, assemblages, and even concepts and bodies of knowledge that connect various groups of people but that are experienced, configured, meant and used differently.¹ Boundary objects ‘inhabit several intersecting social worlds ... and satisfy the informational requirements of each of them’, write Star and Griesemer in their study of the history of the Museum of Vertebrate Zoology at the University of California. These objects are ‘both plastic enough to adapt to local needs and the constraints of the several parties employing them, yet robust enough to maintain a common identity across sites’. Star and Griesemer describe the values and aims of the museum’s founders and subsequent directors and trace how the same collections of specimens are understood by intersecting groups of scientists, curators, conservationists and amateur collectors and naturalists, whose ‘common referent’ is a connection with the natural environment of California.²

It is interesting to note that Star developed this idea while looking at ‘the nature of cooperative work without consensus’.³ The boundary object is important to this process, as it resides ‘between social worlds’, worked on by different people in different ways to retain a number of identities that are both common and more specific.⁴ In this sense, the Synthi 100 could be said to do ‘boundary work’ – for example, in this chapter, which concerns the BBC Radiophonic Workshop’s ‘Delaware’ Synthi 100, we can trace the synthesizer’s role as a boundary object in institutional interactions within the BBC, which required careful cooperation between

¹ Donna Haraway uses the concept of ‘the gene’ or ‘genome’ as an example of such an object, in the sense that it can facilitate communication between different groups of people while being understood in a variety of ways. Donna Haraway, *Modest_Witness@Second_Millennium.FemaleMan[®]_Meets_OncoMouse[™]: feminism and technoscience* (London: Routledge, 1997), p. 249.

² Susan Leigh Star and James R Griesemer, ‘Institutional Ecology, “Translations”, and Boundary Objects: Amateurs and Professionals in Berkeley’s Museum of Vertebrate Zoology, 1907–1939’, *Social Studies of Science* 19 (1989), 387–420 (p. 393).

³ Susan Leigh Star, ‘This is not a Boundary Object: Reflections on the Origin of a Concept’, *Science, Technology, & Human Values*, 35: 5 (2010), 601–617 (p. 604).

⁴ *Ibid.*, p. 605.

various individuals and groups within the organisation. The acquisition and installation of the synthesizer was made possible through both general and highly specific dialogues about its properties and use between the Workshop's Organizer Desmond Briscoe, studio manager Brian Hodgson, Peter Zinovieff at EMS, the Radiophonic Technical Committee – who made decisions about purchasing equipment – and the Superintendent Engineer who allotted the funds to buy it. The synthesizer acted as a translator between various desires, needs and aims and within certain processes, including: Briscoe's recognition of the need to modernize the studio; Hodgson's specific demands concerning synthesizer, tape and sequencing capabilities; Zinovieff's development of a product to suit these demands; and the BBC's investment in new technology; as well as within the creative working relationships between studio managers such as Hodgson and composers such as Dudley Simpson. In the context of the BBC Radiophonic Workshop, the Synthi 100 is just one object – or concept, or collection of objects – among many that we could select for having 'boundary' characteristics; however, its role as an artefact that held different meanings for different individuals and groups, but that was also understandable in relation to 'material and infrastructural properties' of various kinds,⁵ makes it particularly suitable for this reading.

Star and Griesemer's model of boundary objects and their capacity for translation is useful for organology-based studies of electronic music practices and communities, including those communities which develop and make instruments and music technologies. For example, through a case study of synthesizer reconstruction in Chapter Seven, I consider how the reconstruction and new use of 'obsolete' music technologies further complexifies the boundary object, as new boundary spaces emerge for it to inhabit at different points in time. A reconstructed 'boundary object' makes very clear Star's notion that the boundary object's use and properties can change over time through renewed use by different groups of people: it is not only perceived differently by its new users, but actually *made differently* by and for them. In reconstruction, some of its material properties will change; but also, its cultural and social identity shifts to that of 'an historical synthesizer'. While it may still be known as 'a Synthi 100', this term has different meaning and value when referred to by, for example, a collector of 'vintage' electronic instruments, the programmer of an arts

⁵ Ibid., p. 613.

event, or indeed by a researcher such as myself. Considered as a boundary object, it can effect and has effected numerous translations, being meaningful, dynamic, obsolete, and then refigured with different meanings, by different social worlds, and in different historical eras.

5.3 Electronic music and audiovision

5.3.1 Modernising the Workshop

The minutes of the BBC's Radiophonic Technical Committee from 29 September 1969 record that a new piece of equipment called the 'Delaware Studio' had recently been ordered and would be installed in Room 10 of the BBC Radiophonic Workshop, a space that had been set aside the previous year for new and updated equipment.⁶ This decision was the result of extensive discussions among the members of the Radiophonic Technical Committee, a group representing the various departments of the BBC that commissioned the music and sounds produced by the Radiophonic Workshop. The group had been set up by the Workshop's organiser Desmond Briscoe in response to requests from the Workshop's studio managers – who included Delia Derbyshire and Brian Hodgson, Peter Zinovieff's collaborators in Unit Delta Plus (see Chapter 2) – for voltage-controlled synthesizers, as well as other equipment to modernise the increasingly outdated Workshop. In February 1969 Briscoe brought these concerns to the Technical Committee, reminding them that, 'for the first time since the setting up of the Radiophonic Workshop [in 1958], equipment specifically designed for electronic music is now on the market'. These new devices were not only exciting but efficient, with the potential to 'save many hours' for staff and increase productivity, benefiting the studio staff but also the programme makers who used their services.⁷ As it was presented to the Committee, the issue was not just one of buying new items, but of a wider policy of committing to the modernization of the Radiophonic Workshop so that it could produce more music and sound effects for an increasing number of radio and TV programmes.

In outlining his concerns in this way, Briscoe hoped to secure funds for the Workshop to invest in one of the new voltage-controlled synthesizers being

⁶ WAC R97/10/2, 1969. References beginning 'WAC' refer to the BBC's Written Archive Centre; see Bibliography for details of specific collections used.

⁷ WAC R97/10/1.

manufactured in the US. This was part of a programme of updating equipment, much of which had remained much unchanged since the beginning of the 1960s.

Demonstrations and meetings were set up with a number of companies providing audio products, including Audiotek, the UK distributors of Moog synthesizers, who gave Briscoe a price list breaking down the cost of a Moog 900 Series, models I, II and III, module by module.⁸ Briscoe had been in touch with Audiotek since 1968, and was aware of the Moog synthesizer that they had recently sold to Manchester University. In 1969 Briscoe had arranged a demonstration of a Moog at the BBC and spent some time preparing reports for his colleagues, out of a necessity to explain to them ‘exactly what a synthesizer was and how it differed from existing equipment’.⁹ An item costing around £3000 or £4000 – a significant part of the Workshop’s annual budget – would not be signed off by the Superintendent Engineer Radio Broadcasting unless its value could be thoroughly explained and justified.¹⁰

Purchasing equipment for the Radiophonic Workshop was not a straightforward process. Briscoe had to negotiate the different priorities of employees such as Brian Hodgson, who were eager to try out new technologies, and those in charge of equipment budgets, while negotiating the Workshop’s share of the bulk allotment funds for TV and radio which were distributed among the whole departments. This meant that equipment was acquired sporadically, much to the frustration of Hodgson. As he explains, it was not only that money was often in short supply, but also that the allocation of money year on year was unpredictable; and when money was available, there was a tendency to choose expensive items rather than sourcing cheaper alternatives. He says,

The problem with that was you would suddenly be faced with buying something because there was money available, but it wasn’t necessarily what you needed. So you tended to get, like, a £40,000 Neve mixing console when what you were in need of were basically some proper tape recorders and proper basic studio equipment in each of the studios. I used to say to Desmond, ‘You’re just icing the cake, and the cake is actually rotting from within’.¹¹

⁸ WAC R97/10/2.

⁹ Louis Niebur, *Special Sound: the creation and legacy of the BBC Radiophonic Workshop*. (Oxford: Oxford University Press, 2010), p. 129.

¹⁰ The synthesizer itself was only part of the expense involved in setting up Room 10: tape recorders and loudspeakers would also be required, bringing Briscoe’s estimate to £5000.

Niebur, p. 129.

¹¹ Brian Hodgson, interview with author, 2016.

5.3.2 Between sound and music

Brian Hodgson was born in Liverpool in 1938 and trained privately as an actor before coming to work in the drama department of the BBC in 1961, and then joining the Radiophonic Workshop in 1963. He had a background in neither music nor engineering, although during his national service in the Air Force he had worked as a wireless mechanic and with radar. Not unusually for his generation, he had some basic knowledge of electronics from fixing and experimenting with radios and audio equipment at home.¹²

Hodgson's career at the BBC Radiophonic Workshop and in his own studios reminds us that historical narratives of electronic music are closely connected to histories of media such as film and television.¹³ Louis Niebur, Mark Brend, David Butler, Theresa Winter and others have argued that the growth of electronic music in the UK and public perceptions of it were linked to its presence in broadcast media from the 1950s to the 1980s.¹⁴ This has meant that the innovative nature of the music and sound produced for TV and radio in the UK has been slow to be recognized, as it was conceived to be and has historically been perceived as purely functional, unlike in numerous other European countries where broadcasting studios often provided space both for the composition of programme music, sound effects and so on, and 'autonomous' electronic concert music.¹⁵ However, in recent years, as studies such as those cited above – as well as many articles in the popular music press, radio documentaries and events such as BBC Prom concerts – demonstrate, the significance of the music produced at the BBC Radiophonic Workshop has been reassessed, and its important role recognized.¹⁶ While this phenomenon is not the main focus of my study, it indicates that further investigation is needed into the ways in which what we

¹² Brian Hodgson, interview with author, 2016; Desmond Briscoe and Roy Curtis-Bramwell, *The BBC Radiophonic Workshop: The First 25 Years* (London: British Broadcasting Corporation, 1983).

¹³ In Hodgson's case we could add theatre to this list, as much of his work outside of the Radiophonic Workshop was for stage productions; he also worked with dance companies.

¹⁴ Niebur, *Special Sound*; Brend, *The Sound of Tomorrow*; David Butler, 'Way out of This World!' Delia Derbyshire, Doctor Who and the British public's Awareness of Electronic Music in the 1960s', *Critical Studies in Television* 9: 1 (2014), 62–76; Theresa Winter, 'Delia Derbyshire: Sound and Music for the BBC Radiophonic Workshop', 1962-1973 (unpublished PhD, University of York, 2015).

¹⁵ The most famous examples being Milan's Studio di Fonologia, at the state broadcaster RAI; the electronic studio at Westdeutscher Rundfunk; and INA-GRM at Radiodiffusion-Télévision Française in Paris.

¹⁶ The Pioneers of Sound concert at 2018's BBC Proms was programmed as a 'tribute' to the BBC Radiophonic Workshop and included compositions by Daphne Oram and Delia Derbyshire. <https://www.bbc.co.uk/programmes/b0bcmbws>

understand as the roles of electronic musicians, composers, producers, sound designers and sound effects creators are historically and culturally contingent, particularly in the area of electronic music and sound design for film and television, in which fundamental issues of how an audience sees and hears mediated sound and image – described by Wolfgang Ernst as the ‘conceptually implied unity of “audiovisual” perception’ – come to the fore.¹⁷ Drawing on Michel Chion’s writing on ‘audio-vision’,¹⁸ we could view the broadcast sound studio as a place for sonic experimentation not merely because those institutions have historically provided the space and the equipment for electronic music to be made, but because technologies of broadcasting are deeply implicated in and co-constitutive of electronic music as we understand its development in the twentieth century.

In this chapter I want to propose a connection between electronic music and broadcasting which is less concerned with the relative merits of functional or autonomous music and more with the development of electronic instruments. In thinking about how and why instruments such as the synthesizer developed, and in response to whose needs, we might think about how broadcast media in the 1960s and 70s contributed to the formation of the music technology industry by creating a market for instruments which had the capacity for the recording, storage and transformation of sounds and which would be particularly suitable for making sound effects and signature tunes, not only effectively but also quickly and efficiently, to meet tight production schedules.

As we saw in Chapter Three regarding the various roles ascribed to Peter Zinovieff in his studio, electronic music and sound, as well as widening the field of composition, had the potential to challenge professional categories such as composer, musician, producer and engineer. The rise of audiovisual technologies added further potential for existing roles to change, expand or overlap, and for new ones to be created. At the Radiophonic Workshop Hodgson’s work was, as James Gardner has remarked,¹⁹ what we would probably now call sound design – that is, devising sound environments for drama and documentaries – as well as creating electronic treatments for already composed theme tunes and incidental music. His combined experience of

¹⁷ Wolfgang Ernst, *Chronopoetics: The Temporal Being and Operativity of Technological Media*, translated from German by A. Enns (London: Rowman & Littlefield, 2016), p. 138.

¹⁸ Michel Chion, *Audio-Vision*, translated and edited by Claudia Gorbman (New York: Columbia University Press, 1994).

¹⁹ James Gardner, ‘Interview – Brian Hodgson’, supplementary interview to *These Hopeful Machines* series (Radio New Zealand, 2013).

and interest in drama, media, sound and technology resulted in a new creative role that inhabited, as Hodgson himself put it in the early 1980s, ‘the area lying between sound and music’.²⁰ While Hodgson operated within a musical milieu as part of the short-lived group Unit Delta Plus with Delia Derbyshire and Peter Zinovieff (see Chapter Two), his primary concern was how sound could be used to enhance the visual: either the direct visual referents of television or stage, or the radio listener for whom the radiophonic effect evokes imaginary visions. As Niebur writes, ‘Hodgson’s forte was finding and assembling the right noises – the right component sonic elements that combined create unique timbral collections for a work’.²¹

Niebur appears to differentiate this skill from that of the composer; however, his description could just as easily be applied to the working methods of a composer of *musique concrète* in the 1960s or the composer of electroacoustic or ambient electronic composition today, who not only perceives sounds as Schaefferian ‘objects’ similar to Hodgson’s sonic ‘elements’, but also might work alongside visual artists or incorporate visual material into a composition. What distinguishes these roles from one another, then, are not necessarily differences in methodology but rather a complex interplay of aesthetic and social categories concerning what constitutes a musical work and a musical worker.

This problem of defining electronic music and sound design manifested in the professional hierarchies in place at the BBC, as seen in Briscoe and Curtis-Bramwell’s account of how Radiophonic Workshop staff were perceived in relation to composers. Composers were seen as specialists who were commissioned to write musical scores, not in-house staff assembling electronic music in studios: this was, quite understandably, seen as closer to sound effects.²² However, Niebur relates that Briscoe, in the early 1960s, fought to keep the Radiophonic Workshop within the same building as Music and away from the Sound Effects department, in an attempt to emphasise that the Radiophonic Workshop was producing something more imaginative than Foley sound, or sound that was directly indexed to images.²³ What to call people like Hodgson remained a problem throughout the decades: initially known as studio managers, by the 1980s they were ‘radiophonic producers’.

²⁰ Hodgson quoted in Briscoe and Curtis-Bramwell, p. 72.

²¹ Niebur, p. 95.

²² Briscoe and Curtis-Bramwell, p. 68.

²³ Niebur, p. 122.

Brian Hodgson's own account of his work suggests an attitude towards his career in electronic music and sound that, whatever his personal tastes might be, was unconstrained by an allegiance with a particular genre of music, or indeed even any particular art form. While taking on projects that could be considered experimental or avant-garde – such as Jane Arden's play *Vagina Rex and the Gas Oven*, performed at the Arts Lab in London in 1969, for which he provided sound and other technical assistance – he was also happy to make soundtracks for advertising, which, as we saw in Chapter Two, was one of the points of contention within Unit Delta Plus.²⁴

As the only surviving member of the Radiophonic Workshop who can claim to have worked there from the early 1960s through to the mid-1990s, Hodgson has come to be one of the predominant voices in histories of the Workshop. In particular, he has played an important role in promoting – and in some senses, gatekeeping – the legacy of Delia Derbyshire: following her death in 2001, his recollections of their working life and personal friendship have shaped public understanding of her life and work.²⁵ As a practiced and enthusiastic interviewee, he has developed what the sociologist and oral historian Alessandro Portelli calls the 'legendary complex',²⁶ creating a role for himself as someone who strove in the face of adversity for things to be better than they were. He frequently gives the impression of himself and Delia Derbyshire as forward-thinking adopters of new technology and new ideas who were up against the entrenched attitudes of their bosses and the company as a whole. During our interview his anecdotes often concerned a problem to which he found the solution, whether that was writing the Synthesizer 100's manual, building a stage at the Arts Lab, or organising a holiday for himself and Derbyshire. Sometimes in Hodgson's account the Delaware becomes another one of his adversaries, as a machine that promised much but that often did not work as well as it should; a device around which the 'legendary complex' could form or through which it could be expressed.

But this capacity for problem-solving and organisation is borne out by Hodgson's track record at the BBC, not least his return to the Workshop in 1979 to oversee a radical restructuring of the studios in the early 1980s. This required an unsentimental attitude towards the Radiophonic Workshop's past and the willingness to risk

²⁴ Brian Hodgson, interview with author, 2016.

²⁵ See Niebur, *Special Sound*, but also Winter, 'Delia Derbyshire'; Gardner, 'Interview – Brian Hodgson'; and the radio documentary *Sculptress of Sound: The Lost Works of Delia Derbyshire*, BBC Radio 4, 2010.

²⁶ Alessandro Portelli, 'The Peculiarities of Oral History', *History Workshop Journal* 12: 1 (1981), p. 100.

investing in new devices. In 1983 he justified what could be seen as an overly technocentric attitude thus:

I have a big bee in my bonnet about equipment and have made myself become interested in it, and tried to understand it, because the better the equipment we have, the less we filter ideas and emotions and the more directly we can convey them.²⁷

To some extent Hodgson was repeating a company line here – that the BBC invests in technology primarily in the service of providing a more authentic emotional and artistic effect for the viewer or listener, rather than out of a desire to explore new technologies for their own sake, which might be seen as a waste of license-payers' money. He was also voicing an attitude towards music technology that we have seen many times in previous chapters: an assertion – perhaps even a reassurance – that technology does not take the place of, but rather enhances, makes *more* authentic, even, the human, the creative and the emotional experience, which is why one has to 'make' oneself interested in it (the implication here is that this would not happen naturally).

However, when I asked about the Delaware, he focused mainly on its efficiency as a device, rather than its capacity to convey emotion through sound. Hodgson's response suggests a number of things: firstly, of course, his awareness of my research interest in the instrument's use and effectiveness; secondly, that in talking to me in the present day he was no longer under any obligation to justify technological investment in the Radiophonic Workshop by talking about audience reception. But as we will see later in this chapter, for a number of its users the Delaware did not turn out to be the modernising force that it was intended to be. Hodgson's role in agitating for the modernisation of the Workshop may have helped to cause his eventual frustration with the Synthi 100 – the hugely expensive but not always reliable instrument that had been presented so proudly as the solution to the Workshop's needs.

²⁷ Hodgson quoted in Briscoe and Curtis-Bramwell, p. 73.

5.3.3 Switching to synthesizers

Although a commitment had been made to updating the studio in the late 1960s, the high cost of a Moog synthesizer and the unfamiliarity of the instrument meant that Briscoe had to make a convincing case for it to the radio and TV departments. When EMS launched the smaller, cheaper VCS3 synthesizer in 1969, Briscoe was able to propose a more realistic option for the studio with the added advantage of being seen to support British manufacturing. The VCS3 was not the unknown quantity that the Moog system was: Hodgson and Derbyshire were already committed to using the VCS3, while two of the directors of EMS, Tristram Cary – who had composed music for the BBC and appeared on radio and TV programmes – and Peter Zinovieff, were well known to Briscoe already. The connections between Briscoe, Hodgson, Derbyshire, Zinovieff and Cary must have encouraged EMS London Ltd's founders to hope that their new company could become the go-to synthesizer supplier for broadcasting.

As Briscoe continued to negotiate with Moog, he was considering this local alternative, and in 1970 he recommended to the Superintendent Engineer of Radio Broadcasting that a VCS3 should be bought from the radio and TV allotment fund.²⁸ This request was approved, and the VCS3 became part of the Radiophonic Workshop's set-up: the following year, another was bought. Hodgson describes his role in the acquisition of the EMS synthesizers.

Desmond Briscoe had been to America, to Wisconsin, to do seminars on creative radio, and had met Bob Moog, and it was decided – Desmond thought we should have a Moog synthesizer. So he came back all fired with Moog, and then Delia and I bought a VCS3 from Peter [Zinovieff], and I think we bought a Portabella [the alternative name for the Synthi A]. Then Peter started talking about something called the Belgrade, which was basically going to be three VCS3s bolted together for Radio Belgrade. ... David Cockerell had invented a digital sequencer, which did 64 events; now, Moog had an analogue sequencer that did eight events – so you could see where our mind was going. So Delia and I said we really ought to buy British, because also it'll be better as we can do 64 events.²⁹ So there was a long battle – Delia and I had enormous battles with Desmond – and it was decided – because by then the workshop didn't have a VCS3, but Delia and I did, and would take it in and work on it. There's the

²⁸ WAC R97/10/2, 1969.

²⁹ This eventually became the Sequencer 256.

famous story of the Chief Engineer of Radio coming along, and we were explaining it to him. And Delia and I said, ‘we really need to have a synthesizer here,’ and he said, ‘You’ve got one’, and we said, ‘No, it’s ours, we bring it in’, and that then geed him up to buy one as a sort of gift to us.³⁰

Hodgson’s account condenses a number of events which are unlikely to have happened in exactly the sequence he recalls.³¹ But his version of story is useful in showing in how quickly the Synthi 100 (the ‘Belgrade’) began to be developed after the launch of the VCS3, and in giving the reader a sense of the pace and rhythm of EMS’s early years of production, in which David Cockerell’s inventions rapidly took shape and adapted to fit clients’ demands as well as EMS’s own interests. Hodgson’s anecdote about the Chief Engineer demonstrates the institutional and even ideological role that technology came to have during this period in the Radiophonic Workshop, as the acquisition of new devices became a way of demonstrating that the BBC could keep up with and support the new electronic musical instrument industry, as well as providing facilities that would be as good as, if not better than, those that its staff were managing to access and even create for themselves elsewhere. EMS, both as company and studio, was one of the main catalysts for this new activity at the Workshop, not only in producing affordable instruments for the BBC to buy but also creating other opportunities for the Workshop’s studio managers to make electronic music, which then fed into their work at the BBC.

Hodgson’s version of the Radiophonic Workshop as overly bureaucratic on the one hand, and as a rather chaotic but dynamic enterprise staffed with volatile and resourceful creative people on the other, is supported by a *Guardian* article published in September 1970, which paints a vivid picture of a space in which ‘clever’ new technologies were the source of pride for the institution, yet at the same time handled rather carelessly:

Most interesting, of all the hardware in the studio, is a brand new EMS VC3 [*sic*], a voltage controlled studio in itself, housed in a casing about the size of a small desk. Trustingly propped for the moment on an ageing swivel chair, this treasure box is said to be the equivalent of a whole roomful of ordinary instruments and by the end of the year the

³⁰ Brian Hodgson, interview with author, 2016.

³¹ For example, the Synthi A/Portabella was not available until 1971.

workshop hopes to take delivery of a £6000 version on a larger scale, and even cleverer.³²

The journalist Kirsten Cubitt's main interview source for her article was Delia Derbyshire. We can assume then that Derbyshire told her about the '£6000 version', thus setting the stage for the synthesizer that, when the article was published, had only just been ordered.

Derbyshire was being a little optimistic about the arrival of the Synthi 100, which did not arrive until April the following year. Briscoe had met with Zinovieff in July 1970 to discuss commissioning a synthesizer to the same specifications as the one being built for Radio Belgrade for the BBC, with a few modifications to suit the needs of the Workshop, such as BBC-specific peak programme meters.³³ He passed Zinovieff's quote of £5400 onto the Superintendent Engineer Radio Broadcasting and in August the Superintendent Engineer contacted Zinovieff to let him know that the matter was under 'urgent consideration' at the BBC and that he could expect an order soon.³⁴

Once manufacturing was underway, Hodgson visited the EMS factory in Wareham to check on the process of the synthesizer – it was he, therefore, who first noticed that the machine would be too big for the corridor and doorway of the studio, meaning that the door needed to be widened and a concrete support put in the wall to accommodate the machine: a process, he says, that cost 'almost as much as the synthesizer'.³⁵ This is a frequently told story of Hodgson's, as is his account of when the synthesizer, named the 'Delaware' after the road in Maida Vale in which the Workshop was situated, arrived, and it soon became clear that there was no manual for it. Consequently, David Cockerell was called into the studio, and he and Hodgson spent a day and night working through the Delaware's functions and drafting a manual.³⁶ These anecdotes gesture both towards the excess of the instrument – so big it required expensive structural changes to be made to a building – and its somewhat unfinished quality, arriving late and without a manual. However, the Radiophonic

³² Kirsten Cubitt, 'Dial a Tune', *The Guardian*, 3 September 1970.

³³ WAC R97/10/2, 1970.

³⁴ WAC R97/10/2, 1970.

³⁵ Brian Hodgson, interview with author, 2016.

³⁶ Niebur, p. 133; Brian Hodgson, interview with author, 2016. Niebur's account is slightly different, indicating that Dick Mills, another Radiophonic Workshop studio manager, helped write the manual with Hodgson.

Workshop was able, by the following month, to showcase their new purchase to an important audience.

5.4 A triumph of collaboration: the IEE concert

On 19 May 1971, the BBC Radiophonic Workshop put on a concert at the Royal Festival Hall to celebrate the centenary of the Institute of Electrical Engineers. This prestigious event, titled *The Radiophonic Workshop in Concert*, was a major achievement for Briscoe, who also put together an exhibition about the Workshop for the Festival Hall's foyer, and opened the concert with a detailed introduction, illustrated with film and sound clips, describing the Workshop's history and current activities. On stage, in an echo of the Redcliffe Concert of Electronic Music at Queen Elizabeth Hall a few years previously, at which Peter Zinovieff's computer had been brought onto the stage, were displayed six VCS3s and a Synthi 100, which would be used for the premiere of a new composition by Delia Derbyshire. (This was not the Delaware itself, as this was installed in the studio and could not be moved, but Zinovieff's own Synthi 100 from EMS.) The smaller synthesizers were set up dramatically on podiums covered in black cloth, while clips from television programmes were projected behind them, according to what signature tune was being performed; a projection of an oscilloscope accompanied the radio signature tunes. A theatrical display of lights and lasers was put together by the Workshop's studio managers, led by Hodgson and including composers Dick Mills, Paddy Kingsland and Richard Yeoman-Clark.³⁷

Briscoe described the new synthesizer as 'a triumph of collaboration between the scientist and the artist, between the electrical engineer and the composer',³⁸ and indeed Derbyshire's composition fitted this description perhaps more accurately than Briscoe intended. The piece, called *IEE 100*, was built around material from the BBC's archives that showed key engineering achievements of the preceding century, such as the invention of telephony and radio, and, more recently, the Moon landings; other material was generated by analysis of the letters, sounds and numbers of the piece's title, both mathematically and using vocoding techniques similar to those Zinovieff was exploring in his work with Harrison Birtwistle at around this time

³⁷ Delia Derbyshire Archive, DDA/1/30/754.

³⁸ Niebur, p. 134.

(notes and a surviving tape in the Derbyshire archive indicate that Zinovieff contributed material to Derbyshire's piece).³⁹ But this composition could not be performed live on the Synthi 100, and indeed very little of it had been made using the synthesizer in the first place. As Hodgson relates it, the Synthi 100 on stage was there 'long before it was really ready to be used' and, on the night, 'it promptly froze'.⁴⁰ Its purpose, then, was mainly as a visual aid to add weight to Briscoe's claims of a close, productive relationship between science, engineering and art: a single device that externalised and made concrete all the complex procedures, compromises and archival digging that went into making this new piece of music. *IEE 100*, and the concert as a whole, was intended as a display of technological ingenuity rather than of modern music or experimental art. Its remit was to be educational and entertaining, and in this, at least according to the highly partisan account of the BBC,⁴¹ it succeeded.

Writing to Zinovieff the week before the concert, Briscoe thanked him and his EMS colleagues for providing the synthesizers for the performance, and for the Delaware, about which he wrote,

I am very pleased, beyond all expectation; the help and collaboration both during the development and during the past month could not have been better, it has been a pleasure to become the first proud owners of such a device.⁴²

In return, he promised to show the Delaware to any visitors to the BBC who might also be prospective customers, putting in place a relationship between EMS and the BBC that would remain throughout the 1970s, albeit subject to the fluctuations in the resources of both organisations.

5.5 The rise and fall of the Delaware

In June 1971 Brian Hodgson submitted to Desmond Briscoe a progress report on the new synthesizer, which had then been in place for two months. He was positive mostly about the Delaware's effect on workflow, noting that a musical cue that would have taken a day to realize on tape and many hours on a smaller synthesizer was now

³⁹ DDA/1/25/131; CD260.

⁴⁰ Brian Hodgson, interview with author, 2016.

⁴¹ Briscoe and Curtis-Bramwell, pp. 135–9.

⁴² WAC R97/10/2, 1971.

achievable in just 34 minutes. His only negative remark concerned the accuracy of the sequencer, an issue which appears to have been partly resolved by an update offered by Zinovieff that increased the number of clock pulses, as well as the permanent installation of a multitrack tape recorder with the synthesizer, a modification which was also carried out on the Synthi 100 in the Belgrade studio. However, Hodgson's report, positive though it is, gives us some idea of the limitations of the Synthi 100's sequencer, the device that had been such a source of enthusiasm for him and Derbyshire.⁴³

Despite his initial enthusiasm for the Delaware, when reflecting upon it in the present day Hodgson maintains that, during his time at the BBC, few compositions were made using the synthesizer as the sole instrument, or as the starting point for a piece. Working on the incidental music for the *Dr Who* series with composer Dudley Simpson, for example, Hodgson describes a process whereby Simpson would first compose for and record a small group of musicians; he would then work on the electronic elements of the music alongside Hodgson, who would operate the VCS3s or the Delaware. 'It was really very painful getting Dudley to get his head around synthesizers,' Hodgson recalls, but the two developed a working relationship which continued outside of the BBC, collaborating on the music for the ITV series *The Tomorrow People* in 1973. This followed a similar model in combining recordings of a small ensemble with electronic elements and processing of the instrumental material. Hodgson describes the process of working with Simpson at the BBC:

I'd do the realisation and he'd come along and play the keyboards. We had a fast turnaround – if you were doing a *Dr Who*, very often you'd see the finished episode on maybe Monday, you'd have two days to do maybe ten minutes of music, and then it was put on the programme and transmitted the following week. So it was a very fast turnaround and you couldn't be going back to basics every time you wanted to do anything.⁴⁴

There is no doubt that the Delaware helped to make this tight schedule manageable and made it possible for *Dr Who* to have an almost wholly electronic soundtrack by 1971. For one thing, the Delaware's oscillators were much more stable than those of

⁴³ WAC R97/10/1, 1971.

⁴⁴ Brian Hodgson, interview with author, 2016.

the VCS3 and less prone to drifting out of tune in response to changes in temperature, which required lengthy retuning sessions wasting at least an hour of every day. More generally, the way in which huge number of possible sounds and configurations were made possible by just one device also allowed studio managers such as Malcolm Clarke, who embraced the synthesizer, to create whole soundtracks without the involvement of outside composers.

Clarke, whom we met in the previous chapter enthusiastically creating the sound-world of Ray Bradbury's story *There Will Come Soft Rains* with the Delaware and the EMS Vocoder 2000, joined the Workshop in 1969. Niebur recounts how Clarke confidently exploited the possibilities of voltage control synthesis on his music for the *Dr Who* story *The Sea Devils*, broadcast in 1972, a score that Niebur describes as 'notorious' because of its dissonance and lack of sympathy with the visual image and the story. However, he concurs, it 'transforms what was potentially a mediocre story into an atmospheric, disturbing...series of episodes'.⁴⁵ Clarke's compositions also mark a shift from the traditional composer-to-producer workflow of much of the Radiophonic Workshop's output to a situation in which an electronic composition was not necessarily an arrangement of a previously existing instrumental score but could be a wholly new piece whose starting point was the possibilities of the electronic musical instrument as well as the dramatic demands of the story it was soundtracking.

The acquisition of the Delaware both reflected and instigated changes in the BBC Radiophonic Workshop. Niebur suggests that its arrival set in motion institutional changes regarding the roles of engineering staff, composers and studio managers, and that it influenced the decision of important early members of the workshop Delia Derbyshire and John Baker to leave the institution. Hodgson also left the BBC in 1972. His contact with EMS and experience in using the company's synthesizers helped him to prepare for his next venture, Electrophon: a studio based in Covent Garden that would provide music and sound for film, television, dance and theatre productions. The availability of voltage-controlled synthesizers, along with the expertise that producers like Derbyshire and Hodgson had gained at the BBC, made it increasingly feasible to set up a small independent studio such as this.⁴⁶ Hodgson also used the contacts he had made at EMS's manufacturing operation to kit out

⁴⁵ Niebur, p. 144.

⁴⁶ Electrophon was initially intended to be a joint venture with Derbyshire, but her involvement was minimal. Brian Hodgson, interview with author, 2016.

Electrophon to his own specifications, working with Ken Gale, the designer at Rodgers Studio Equipment (the company set up by Brian and Gerry Rodgers, who also operated as EMS Bournemouth and ran EMS's manufacturing operation in Dorset), on a new mixing desk and synthesizer modules for his studio, which also housed three VCS3s.⁴⁷ To control the modules, Rodgers Studio Equipment supplied some of the same large matrix boards that were used for Synthi 100s. But as well as providing invaluable experience – and some spare parts – the Delaware had also helped Hodgson to decide what not to do when setting up on his own. Writing in 1977, he explained:

It was decided that Electrophon would not purchase a large complex synthesiser like the Moog, ARP or Synthi 100. This decision was taken for two reasons: firstly, I felt that a modular approach would make it possible to keep abreast of the rapidly changing technology; and secondly, I wished to keep close contact with equipment designers so that we would end up with a range of modules that did what we wanted, and not what a design engineer thought we would want. In this we have been moderately successful in spite of the fact that money supply usually lags a year or so behind the birth of any idea.⁴⁸

This account, written for *Studio Sound*, was intended to promote Electrophon, and therefore presents the decision-making process behind the studio as fully intentional rather than, more realistically, indicative of what Hodgson, who had cashed in his BBC pension in order to set up Electrophon, could afford, and what was readily available to him through his contacts. However, his modular approach was astute, even if it might seem, on first glance, to hark back to the earlier, more 'classical' model of an electronic music studio before the arrival of discrete voltage-controlled synthesizers. Having seen first hand at the BBC the cost of purchasing, housing and maintaining the Delaware, Hodgson would rightly have been wary of making such an acquisition for his own, much smaller studio.

At the Radiophonic Workshop, Hodgson's suspicions were proved correct. The Delaware continued to be used throughout the 1970s, but, as one report claimed in 1973, somewhat less than might have been expected: Dick Mills, the producer who

⁴⁷ Brian Hodgson, interview with author, 2016.

⁴⁸ Brian Hodgson, 'Studio Synthesis', *Studio Sound*, July 1977.

had taken over much of Hodgson's work on *Doctor Who*, 'relies heavily on tape manipulation and he is now building up the Doctor Who soundtracks using mainly tape techniques and the smaller VCS3 as a sound source'.⁴⁹ Meanwhile, Peter Zinovieff attempted to interest Desmond Briscoe in his new invention – a device that would enable computer control of the Delaware as well as other analogue synthesizers. In a proposal to Briscoe in March 1975 he included the specifications of the Computer Synthi, a large unit containing a DEC PDP8 computer of the kind used in the EMS studio and a digital oscillator, to be built to the same height and depth of the Delaware so that it could be slotted alongside it in a studio.⁵⁰ It featured the same kind of matrix boards as the synthesizer; these provided the interface for connecting the Computer Synthi with the analogue synthesizer via analogue to digital and digital to analogue converters. Like the sequencer panel of the Synthi 100, functions such as recording, editing and playback were controlled by push buttons. Overall, the Computer Synthi could be seen as a logical and sophisticated extension to the Synthi 100's sequencer, offering the same capacity to remember and store musical information so that it could be reconfigured and edited without the deterioration caused by tape editing; now, with a larger memory (and the potential to install more), the limited number of musical events that was the pay-off of the sequencer's accuracy could be increased many times. The computer control and the digital oscillator also offered a solution to the time-consuming process of setting up and tuning a large analogue synthesizer. Perhaps most importantly, as far as EMS was concerned, the Computer Synthi provided a way into making music with a computer, introducing the Synthi 100 user to the MUSYS software had been developed at EMS by Peter Grogono and Jim Lawson. Additionally, Zinovieff claimed, soon it would also be possible to use MUSIC 5 on it.

However, at a cost of £7500, the Computer Synthi cost significantly more than the Delaware that it was supposed to augment. As we have seen in his interview with Norma Beecroft, quoted in Chapter Three, Briscoe was not particularly receptive to computer technology being used in music; and even if he were, this was a huge sum to spend on improving a device that had already required a lot of negotiation to buy. It appears that he did not respond to Zinovieff, who followed up his query in May with another letter, urging Briscoe to consider this opportunity to 'enormously update and

⁴⁹ Unattributed news clipping, c.1974. Source: BBC Written Archives.

⁵⁰ WAC R97/10/2, 1975.

enhance your Synthi 100' and take advantage of its low cost for a limited period. Zinovieff optimistically claimed that, in the few months between his letters, EMS had had 'discussions with users from all parts of the world': the Computer Synthi was now a serious proposition.⁵¹ Briscoe declined the offer, and did not even mention it to the Radiophonic Committee at their next meeting. Priorities had shifted towards refurbishment of the studios and maintenance of existing equipment. The next major purchase from EMS would be the Vocoder 2000, in 1976.⁵²

In 1979 Brian Hodgson returned to the Radiophonic Workshop to take over as its Organiser, with Briscoe a Head of Department. He had plans to modify the Synthi 100 using new components designed by Ken Gale, 'but then of course the Japanese and MIDI came along and rendered the whole thing – it was a bit like the rather cranky petrol engine being taken over by a rather smooth electric motor', referring here to the availability of new digital equipment made by companies such as Yamaha and Roland. He concludes, 'The Synthi 100 was eventually taken to pieces and I think we sold some of the matrix boards', and also recalls that, 'we sold the [Synthi 100] sequencer to Cardiff [University] because theirs had broken – it was irreparable.'⁵³ The official account, in 1983, was gentler, and more optimistic:

Bits of [the Synthi 100] have been incorporated into other equipment around the Workshop, but the most important chunks are stored awaiting engineers Ray White and Ray Riley to redevelop it into a worthy successor. It has been suggested that when this project is completed, the new synthesizer should be called The Phoenix.⁵⁴

Hodgson's account of the adoption of digital technologies in the Radiophonic Workshop follows a similar pattern to his account of the BBC's adoption of voltage-controlled equipment in the late 1960s: he portrays himself as having to advocate for modernising the studio, pushing for the most economic solutions, fighting with his superiors and, eventually, ending up with the technologically sophisticated, MIDI-

⁵¹ WAC R97/10/2, 1975. This was optimistic, to say the least – as I note in Chapter Four, only three Computer Synthesis were ever made. Robin Wood describes it as 'a white elephant that never worked [...] The hardware they were based on was hardware that was conceived at a time when computers were totally changing.' Robin Wood, interview with author, 2018.

⁵² WAC R97/10/4, 1976.

⁵³ Brian Hodgson, interview with author, 2016.

⁵⁴ Briscoe and Curtis-Bramwell, p. 131.

enabled Radiophonic Workshop of the early 1980s. However, Hodgson's foresight in keeping abreast of both new technology and current trends in electronic music contributed to the Workshop's survival into the 1980s as an advanced 'Mac-driven' studio.⁵⁵ Of having worked with music technology during the 1970s, Hodgson remarks,

It was a very exciting time, and you had be very adept at changing your mind, because what seemed like God's truth one day seemed like a complete waste of time, and that was a little back alley you'd gone up and there was no way out so you'd have to come back and start again.⁵⁶

5.6 Conclusion

In this chapter I have given an account of the BBC Radiophonic Workshop's Synthi 100, known as the Delaware, telling the story of how it came to be made for and bought by the BBC, how it was demonstrated at a concert for the Institute of Electronic Engineers in 1971, and, briefly, how it was used by various producers and composers in the Workshop; I have also described how it was superseded by digital technologies in the early 1980s.

In considering the Synthi 100 within the context of the BBC Radiophonic Workshop, I have reiterated the idea, introduced in Chapters Two and Chapter Three, that in histories of electronic music we also see the emergence of new creative and professional roles, including the broadcast sound designer and the 'radiophonic producer' who, in the case of the Radiophonic Workshop, used a mixture of devices – some perceived as musical instruments and some less so – to create sound recordings that were hard to define as either sound effects and music. While this is a subject for future investigation, I introduce it here as a way of reiterating the unique character of electronic music as a recorded medium, and its interconnection as such with histories of other media such as radio, TV and film. These media, and their technological requirements, were an important early market for EMS's synthesizers and other devices; they also, as other scholars have shown, played an important role in introducing electronic sound and music to popular culture in the UK. I propose that a

⁵⁵ Niebur, p. 183.

⁵⁶ Brian Hodgson, interview with author, 2016.

study of the use of electronic sound in film and TV that looks not only at the historical connections between industries and individuals but also expands on the relationship between sound and image in the area of technologies and processes could be very productive.

Thinking about the Synthi 100 at the BBC Radiophonic Workshop as a media device as well as a musical instrument might also help to challenge one of the historical narratives that have formed around the introduction of synthesizers at the BBC Radiophonic Workshop. This is the notion that, in comparison to the earlier tape methods used there, and the post-1970s techniques of digital sampling, the era of voltage-controlled synthesizers ushered in a lack of sonic and musical variety. This narrative is central to Louis Niebur's account of the Workshop, and is often corroborated, or indeed comes from, oral history interviews with Brian Hodgson, who, as I have indicated, is an important source in historical accounts of the Workshop; it is also reiterated in magazine and website articles and radio programmes about the BBC Radiophonic Workshop. It is not without basis. Contemporary accounts indicate that the VCS3 and Synthi 100 represented technological innovation in some senses, but also signaled, for some listeners, musical and sonic uniformity. For example, when the BBC released *Fourth Dimension and other Synthesizer Music from the BBC Radiophonic Workshop* in 1973, a writer at *Hi-Fi & Record Review* found it to be limited in 'tone and dynamic range', describing the record ultimately as 'too much of a good thing'.⁵⁷ Yet this uniform quality was ascribed to the instruments used, rather than the fact that the theme tunes on the record were never intended to be listened to sequentially in such a way, and that most of them were composed by just one person, Paddy Kingsland. A review of another BBC record released that year, *Radiophonic Music*, which consisted mostly of tape compositions by Delia Derbyshire and John Baker, was more favourable, noting the dialogue between electronic and acoustic sounds that characterised their work: 'many of the pieces gain considerably from the use of acoustic sounds, processed and unprocessed'.⁵⁸

The return, with the digital technology of the 1980s, to a preponderance of sampled and processed concrete sounds, rather than electronic ones, as Hodgson has said, re-opened the possibilities of 'creating sound' that the synthesizers, in his view,

⁵⁷ Anon, *Hi-Fi & Record Review*, November 1973.

⁵⁸ Anon, *Hi-Fi News*, 1973.

had circumscribed.⁵⁹ Yet he also notes that it was not that the synthesizers themselves precluded the possibility of making interesting music but, with their increased efficiency, and the possibility of keyboard control,

‘That then made it easy to do sort of signatures, things like that, and the work changed. Instead of being asked to do complex, abstract scores for Third Programme plays, we were being asked to do local radio sig[nature] tunes’.⁶⁰

We can see here, then, that certain kinds of expectations were placed upon on the synthesizers and their users in the BBC Radiophonic Workshop. The deterministic idea that the synthesizer itself was to blame for a uniformity of sound and could not be used to create ‘complex, abstract’ music is challenged in the following chapter.

In Chapter Six I give an account of the Radio Belgrade Electronic Studio – which was, as we know, the first intended recipient of the Synthi 100. This studio was explicitly a research and composition environment, for which the Synthi 100 had been specifically commissioned. Through the writing, oral accounts and compositions of Radio Belgrade Electronic Studio’s founders and other composers we are able to see how a contemporaneous studio using almost identical technologies explored different compositional principles and philosophies. We will also see how this led to a different kind of operational trajectory for the Synthi 100. Rather than an expensive and unwieldy item that became obsolete only a few years after its acquisition, it was used for many years, and was recently restored and re-presented as an important cultural and heritage object, as I describe in Chapter Seven.

⁵⁹ Brian Hodgson, interview with author, 2016.

⁶⁰ Ibid.

Figure 5.1 Malcolm Clarke with the Delaware, BBC Radiophonic Workshop, 1974. Source: BBC {REDACTED}

Figure 5.2 Stage set up for the Institute of Electrical Engineers event, The Radiophonic Workshop in Concert, Royal Festival Hall, London, May 1971.
Source: unknown {REDACTED}

SYNTHI SEQUENCER 256



Electronic Music Studios (London) Limited,
277 Putney Bridge Road London SW15 2PT
Telephone 01-758 3451/2 Telex 52 83 72
New York: 408 East 78th Street NY 10021
Telephone 212 734 7344 Telex 42 40 33.

MODE SWITCH
Position 1: NEW KEY. A key pulse is sent at the start of each event even if no keyboard attack is made.
Position 2: NEW PITCH. Will not send a key unless there is a gap between events.
Position 3: REMOTE R, D, F. Allows re-writing of second parameters without disturbing first. See (18) SPECIAL.

CLOCK REMOTE JACKS
RESET, START and STOP clock functions can be remotely operated.

CLOCK DISPLAY
Four digit numerical display. Shows position of clock in sequence, and therefore can identify individual events.

LAYER SELECT
Indicates which of the four tracks is being recorded. Others can be heard back if occupied.

EXTERNAL INPUTS
Leading to (18) and (17). A, C, E and D, B, F plus key 1, 2, 3, 4.

INPUT SENSITIVITY
With (18) adjusts level of different types of control input.

INPUT SOURCE SELECTOR
Four position switch selects (1) KEYBOARD (built-in), (2) SPECIAL (see 21), (3) CENTRE-2560 for EMS-type Synthesizer controls, (4) END-2560 for Moog-type (14) control.

CLEAR/RESET
This button not only resets the clock but erases the entire memory, and is guarded to prevent accidental operation.

STOPPING CONTROLS
STOP AT EVENT END. When this switch is down the clock will stop at the end of the current event, until restarted.
STOP AT EVENT START. Clock will stop at start of next event.

CHASE CURRENT EVENT.
Pressing this button will erase a selected track while clock is running. Used with 13 and 14 and the clock controls.

EXTERNAL CLOCK IN
For operation by e.g. an oscillator (see EXTERNAL CLOCK SWITCH).

CLOCK RATE OUTPUT
Voltage proportional to clock speed. For remote indication and control.

EXT./INT. CLOCK SWITCH
In conjunction with EXTERNAL CLOCK IN.

METER AND METER FUNCTION SELECTOR
Normally set to show the amount of steps occupied, but switchable to log track voltages etc.

POWER SWITCH AND PILOT LAMP

VOLTAGE OUTPUTS
All ten output voltages at these jack sockets.

VOLTAGES A, C, E
These three low-voltage controls comprise, second or invert the voltage range of the output, without changing the basic data in the memory. If the voltage were controlling an oscillator, it would define interval A, C, E are the first parameters of each of the three layers, and the controls give zero halfway, expanding normally and inverted in each direction.
Voltage Range: $\pm 5V - 0 - \pm 5V$

VOLTAGES R, D, F
Exactly as A, C, E for second parameters on each track.

KEY 4, 2, 3
This voltage is present for the duration of each event, and would normally trigger an envelope shaper, though it can be used for other purposes. Also variable and invertible.
Voltage Range: $\pm 5V - 0 - \pm 5V$

At rear:
(1) Mono input and face, return input and output jacks.

KEY 4
Key 4 is a separate flash trigger, but only capable of storing key voltages. It can be used to stop or reset the sequencer, to produce a repeated repetition of steps, or for remote control, setting of additional parameter controls. The timing of all four tracks is gate independent. Level as Keys 1, 2, 3.

KEYBOARD
8-button keyboard delivering 'pitch' proportional and dynamically proportional voltage outputs. Connected to sequencer when (18) set to KEYBOARD.

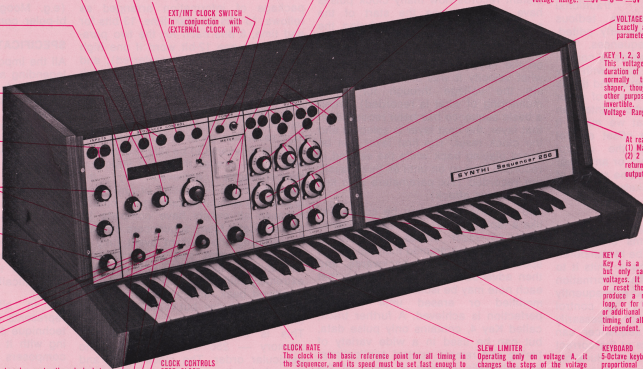

CLOCK RATE
The clock is the basic reference point for all timing in the Sequencer, and its speed must be set fast enough to accommodate the data density provided in some events will be missed. A voltage proportional to clock speed is available at a jack output (24) for simultaneous control of any parameters as clock speed is adjusted. Alternatively a ramp or pulse oscillator may be used as an external clock, and a switch (23) disconnects the internal clock in this case.
Clock Rate Range: 0.1 - 200Hz

CLOCK CONTROLS
STOP CLOCK - clock stops counting
START REVERSE - clock goes backwards
START FORWARD - clock runs normally
RESET - return to zero without stopping clock, unless button held down.

SLEW LIMITER
Operating only on voltage A, it changes the steps of the voltage staircase into 'slow' changes. Applied to pitch, for example, it produces a portamento.
Range of Slow Rate control: 100 - 1000

Chapter 6

‘Openness to all phenomena’: The Radio Belgrade Electronic Studio

6.1 Introduction

Of the thirty Synthi 100s made by EMS in the 1970s, twenty-three were bought by electronic music studios outside the UK. These were, with very few exceptions, situated in universities and music colleges, or in national broadcasting studios.¹ These studios were important loci for establishing communities of electronic music composition and production within their host institutions and, more widely, in the countries and regions in which they were situated. Given the Synthi 100’s centrality to the studios in which it was installed, it therefore played an important part in producing the electronic music of particular locations during the 1970s. In this chapter I look at the connection between the instrument, the studio and the development of electronic music produced in a specific location, through a case study of the Electronic Studio at Radio Belgrade, in the former Yugoslavia. The founding of the Electronic Studio contributed to the development of the Synthi 100 in fundamental ways, and the compositions made on the Synthi 100 in the Electronic Studio, while not widely known outside Serbia, represent some of its most dedicated and creative use during the 1970s and 1980s. I describe the technological and aesthetic objectives that fed into the development of both the Studio and the Synthi, and the work of some of the practitioners based there, in the context of a national and international network of electronic music and other ‘neo-avant-garde’ art forms.² This historical survey of the Electronic Studio provides the background to Chapter Seven, in which I examine some of the objectives that have informed a revival of the studio and restoration of the Synthi 100 in recent years, resulting in its new status as a protected heritage object.

As I stated in Chapter One, this chapter constitutes only a partial account of the Radio Belgrade Electronic Studio’s history, and it is important to make its limitations

¹ Source: Robin Wood, Synthi 100 customers list, 2018.

² A term defined in Dubravka Djurić and Miško Šuvaković, M (eds.), *Impossible Histories: Historic Avant-Gardes, Neo-Avant-Gardes, and Post-Avant-Gardes in Yugoslavia, 1918–1991* (Cambridge, Mass: MIT Press, 2003).

clear. The studio's revival and the Synthi 100's restoration took place towards the end of the research period of this project, and outside of the window allotted for travel funding; therefore I was unable to travel to Belgrade to carry out the kind of fieldwork necessary to provide an in-depth case study. I carried out interviews, for this chapter and Chapter Seven, by Skype and email, and was fortunate to be able to view some archive materials from Radio Belgrade, which were digitised only recently. However, without knowledge of Serbo-Croatian, my access to archive materials was limited to English language sources, such as correspondence between EMS and Radio Belgrade; secondary sources that exist in translation; and English-speaking interviewees.

For the purposes of my research – the primary aim of which was to investigate the acquisition of the Synthi 100 by Radio Belgrade, and to continue my comparative study of the roles and relationships of producers, 'realisers' and engineers in electronic music studios – these limitations are significant, but did not stop my inquiry into those particular topics. However, a full historical account of the Radio Belgrade Electronic Studio would require a much more embedded, less Anglocentric approach, involving fieldwork, working closely with speakers and translators of Serbo-Croatian, and providing a deeper sense of the social and political contexts in which electronic music and other media and art practices were developed in the former Yugoslavian republics. It is hoped that my contribution is a starting point for further research on this topic.

The Electronic Studio was located in the building that housed Radio Belgrade's Third Programme, which had, and still has, a similar function to BBC's Third Programme, now BBC Radio 3, in the UK, broadcasting contemporary music, drama and arts programmes (the corresponding station at Radio Belgrade is now more commonly called Radio Belgrade 3). Radio Belgrade was part of Radio Television Belgrade (RTB), now Radio Television Serbia (RTS), the state broadcaster that produced both radio and TV programmes. The first public electronic music studio in any of the Yugoslavian republics,³ it hosted visiting composers, trained students in electronic music theory and techniques, and thus played an important role in the development of new music in Yugoslavia. In this chapter I give a brief account of the musical and wider artistic context within which the Radio Belgrade Electronic studio was founded, and reflect upon its presence in the cultural landscape of Belgrade in the

³ The only other studio of which I have found a record during the 1970s and 80s is one set up in Sarajevo by Croatian composer Josip Magdić (referenced in sleeve notes of *Elektronski Studio Radio Beograda* LP, 1983); this is referred to as a 'small' studio and it is not clear whether it was an insitutional or private venture.

1970s through performances at festivals such as the Belgrade Music Festival, established in 1969, and elsewhere, such as the Zagreb Music Biennale, Croatia, and the International Festival of Experimental Music in Bourges, France.⁴

The founding of the Radio Belgrade Electronic Studio was the impetus for the creation of the EMS Synthi 100, which began life as a commission for the Belgrade broadcaster. As EMS developed the specifications for this synthesizer, it became apparent to the company that this was a model that could be used in other studios, and, as I have described in Chapters Four and Five, an identical synthesizer was made for the BBC Radiophonic Workshop, which was dubbed the ‘Delaware’. A working generic title for these new synthesizers was relayed in a proposal to Radio Belgrade: ‘Digitana’, a contraction of the words ‘digital’ and ‘analogue’, thus called because it was an analogue synthesizer incorporating a digital sequencer.⁵ As the Belgrade model was in production, two more Digitanas were manufactured, one going to Cardiff University and the other kept in the EMS studio in London. Therefore, by the time Radio Belgrade’s synthesizer was delivered to the new Electronic Studio in August 1971 it had the serial number 3004 – no longer a one-off project, but the fourth in a short run.

However, without the initial commission from the Radio Belgrade, what became the Synthi 100 might not have gone into production when it did, if at all. It might also have retained the name ‘Digitana’ for longer. In 1970, the composer Paul Pignon, a member of the working group at Radio Belgrade tasked with setting up the studio, wrote to Peter Zinovieff at EMS,

I don’t like the name at all – I suppose you have considered it from the sales angle, but I wouldn’t have thought it the sort of name that would appeal to the sort of people that might be customers. Too much like a bad American ad.⁶

While Pignon also admitted that he did not have any alternative names in mind, it is interesting to note that by the time the Belgrade synthesizer was finished, the model was no longer called the Digitana – clearly Pignon was not the only person unsure about the working title of the new machine. As the Synthi 100, it became part of

⁴ From 1973, Bourges hosted an annual electroacoustic music competition and electroacoustic music study days where studio directors as well as composers from different countries could meet.

⁵ Radio Belgrade Electronic Music Studio Archive, 1970 (referred to hereafter as RB EMS Archive. Where possible, exact dates are given).

⁶ RB EMS Archive, 1970.

EMS's Synthi 'family', along with the portable Synthi A and AKS models, also developed in 1970 and 1971.

Continuing my examination of how electronic music has defined and redefined roles such as composer, producer, realiser, performer and so on, and reconfigured their statuses within musical hierarchies, in this chapter I give an account of the creative and technical roles played by Pignon in setting up the Electronic Studio, running its educational programme and composing and performing his own music. Pignon worked in close collaboration with Vladan Radovanović, the Serbian composer who was the director of the Electronic Studio from its inception until 1999. Radovanović's role within the studio was similarly diverse, although along different trajectories: a prolific composer of both musical and radiophonic works, he also acted as a producer/realiser, assisting visiting composers with their compositions in what often amounted to co-authorship; he also contributed greatly to the public profile of the Electronic Studio, organising concerts in Belgrade and Zagreb, and writing and speaking about the Studio's philosophy and activities. Through an account of Radovanović's early career and his position within the wider context of postwar Yugoslavian music and art, I consider the ways in which his aims and aesthetics shaped the Electronic Studio's output, but also how they related to some of the musical and technological concerns of the founders of EMS. With reference to works by Pignon, Radovanović and other composers, I ask how the Synthi 100 facilitated particular compositional ideas and concepts, furthering my ongoing investigation into how certain qualities of an instrument influence and shape its use, while at the same time, its users, as Théberge writes, 'create' the device through the act of making music with it.⁷ The varied, highly creative and technologically knowledgeable use of the Synthi 100 at Radio Belgrade offers a further illustration of the mediated co-creative relationship between music technology and its users that is a recurrent theme throughout this study.

Using oral accounts by Paul Pignon and correspondence from the Radio Belgrade archive between Pignon, Peter Zinovieff, the designer David Cockerell, Radio Belgrade's Velimir Žugic (an electronics engineer from the audio-technical department of RTB) and EMS engineer David Evans, I document how EMS and Radio Belgrade worked together to commission, buy, develop and install the Synthi

⁷ Paul Théberge, *Any Sound You Can Imagine: Making Music, Consuming Technology* (Hanover: Wesleyan University Press, 1997). p. 160.

100. This reveals a process that was at once informal and bureaucratic, combining the experimental, pragmatic approach of EMS as a small, independent company and the verbal, tacit nature of communications between engineers and technicians with the time-consuming formal aspects of working with a public institution on what was, for RTB as it had been for the BBC, a major investment.

There are, of course, similarities to be found between the account of the acquisition of the BBC's Delaware that I gave in Chapter Five, in which the informal, practice-based network of Radiophonic Workshop producers Delia Derbyshire and Brian Hodgson and EMS's Peter Zinovieff came into contact with the dense institutional hierarchies of BBC funding, with Desmond Briscoe as an intermediary between these different milieus. However, there were marked differences in the two institutions' use of their Synthi 100s, which can be seen most obviously in the instruments' operational trajectories. In comparison to the BBC Radiophonic Workshop, the Synthi 100 in the Radio Belgrade studio was used extensively and for many years; in Paul Pignon's estimation, it was being used up until at least 1986, when he left Belgrade.⁸ Svetlana Maraš, the composer who instigated the restoration of the instrument in recent years, estimates that it was used, albeit less frequently, until the early 1990s,⁹ by which time, as we saw in Chapter Five, the BBC Radiophonic Workshop's Synthi 100 had long since been dismantled and its parts sold. Compositions made in the 1980s at the Electronic Studio, including Radovanović's acclaimed radiophonic work *Malo večno jezero* [*The Eternal Lake*] (1984), Pignon's *Mechanical Cartoons* (approx 1980), Frits Weiland's *The Art Of Flying* (1984) demonstrate that the Studio remained an important space for composition, experimentation and education.

This is not to say that the Synthi 100 continued to meet every need of the numerous composers who used the studio, nor that it did not become seen as obsolete or, at the very least, of less value over time. We might also consider that it remained in use due partly to a lack of resources with which to replace it or update the studio. Accounts of the Electronic Studio's later years, as we shall see in Chapter Seven, corroborate that, during years of recession in Yugoslavia in the 1980s, the studio as a whole was greatly under-resourced, and in the early 2000s it fell into disuse. As the Electronic Studio has relaunched in recent years and its history is being more actively

⁸ Paul Pignon, interview with author, 2017.

⁹ Svetlana Maraš, interview with author, 2018.

researched, its tape archives have begun to be digitised and catalogued, with the result that future research will reveal more about the later life of the studio and the use of the Synthi 100 during this period.¹⁰ This chapter serves as an initial enquiry into this area by discussing how the Synthi 100 offered a new way of thinking about composition and helped to define an identity for the studio within Yugoslavian music and art movements in the 1970s.

6.2 Commissioning, installing and problem-solving: EMS and Radio Belgrade

Paul Pignon, who was born in the UK, moved to Belgrade in the early 1960s, where he worked as a writer and translator alongside composing and performing as a saxophonist and clarinettist. A physics graduate who had abandoned a PhD to pursue music, on moving to Belgrade he met Vladan Radovanović, who since the 1950s had been experimenting with Cagean chance-based composition techniques and flexible scoring, as well as tape music and Fluxus-inspired intermedia artworks.¹¹

Radovanović and Pignon collaborated on some compositions and discussed ideas for an Electronic Studio at Radio Belgrade. They were supported in this aim by Alexander Acković, whom Pignon describes as ‘a visionary head of the Third Programme ... who managed to somehow squeeze money out of the radio to found the studio, to our great delight.’¹² A group was set up to establish the studio, which included Pignon, Radovanović and engineers Momčilo Ivanišević and Velimir Žugić (who was also head of the Audio Division of RTB’s Technical Research and Development department), with Pignon given the task of sourcing equipment.¹³

As Pignon notes in our interview, EMS was one of the only companies he would have considered approaching at the time: there was certainly no one else in Europe whom he could ask to build a synthesizer of the kind he envisaged for the studio. He was interested in what he had heard about Buchla synthesizers, which were beginning to be produced in California, because they encouraged a non-keyboard focused

¹⁰ Svetlana Maraš, ‘How Radio Belgrade’s EMS Synthi 100 was repaired’, *Unearthing The Music* (2019) <https://unearthingthemusic.eu/posts/how-radio-belgrades-ems-synthi-100-was-repaired-svetlana-maras/>

¹¹ Melita Milin, ‘Serbian Music of the Second Half of the 20th Century: From Socialist Realism to Postmodernism’, in *Serbian and Greek Art Music: A Patch to Western Music History*, ed. by K. Romanou, K. (Chicago: Intellect, 2009), p. 85.

¹² Paul Pignon, interview with author, 2017.

¹³ *Third Program*, ‘Electronic Studio’ supplement, 1973. A quarterly journal published by the Third Programme consisting of selections from broadcasts.

approach to composition similar to that demonstrated by EMS with the VCS3, but had been unable to strike up a correspondence with Don Buchla. Having met Peter Zinoveff and visited the Putney studio on another occasion – although he does not recall exactly when this took place – he arranged another visit to EMS in September 1969.

Writing in 1974 for *Interface* journal, Pignon outlined what he had specified for the new studio:

... a large complement of analogue modules with the maximum of voltage control, and a sophisticated sequencer which could control these devices, plus of course measuring and monitoring units, and with pin patching as already used by EMS.¹⁴

His recollection of commissioning the synthesizer gives the impression of a much more organic and discursive process, with EMS's David Cockerell assuming a central role.

I had experience with the VCS3 a bit, so I knew the principle, and I'd been at Peter's studio in London and I saw this stuff, and I thought, well, can't you build us something really powerful, along the same lines, without the rather embarrassing weaknesses of the VCS3 [...] There were things about [the VCS3], like the power supplies weren't powerful enough, so if you connected too many things the oscillators would start to slide because they weren't getting enough power, and stupid stuff like that. But the principle is great – I love the patch system – so something along those lines but really big. And then David Cockerell, who was the electronics genius there, said that we could also have a digital sequencer, which he had the idea for, so we said, 'Yes, OK' – we signed a contract, you know: 'For this much money, you will build us some huge synthesizer', and that's how it started.¹⁵

As we will see, ideas for the new synthesizer arose out of friendly conversations at EMS between people who were knowledgeable in their field, and were then formalised through interactions with the institution that was buying the instrument.

¹⁴ Paul Pignon, 'The Radio Belgrade Electronic Studio: Equipment, Procedures, Other Information', *Interface* 3: 2 (1974), 177-186 (p. 177).

¹⁵ Paul Pignon, interview with author, 2017.

Additionally, multiple written and verbal conversations took place between engineers at EMS and RTB regarding specific features of the Synthi and its installation. These various interactions show how, as Geoffrey Bowker and Susan Leigh Star describe in their study of classification systems, *Sorting Things Out*, different ‘communities of practice’ interact within themselves and with each other around a commonly understood object.¹⁶

Shortly after Pignon’s visit to EMS, Zinovieff wrote to him confirming that EMS would supply the synthesizer for the new studio. In the letter Zinovieff noted that it might be possible to include, as well as the voltage-controlled system, ‘some tiny computer, or processor that would act as a very elaborate sequencer’;¹⁷ this would develop, as the design process continued, into Cockerell’s 188-step and then finally 256-step sequencer. From their correspondence it seems clear that Pignon shared Zinovieff’s enthusiasm for a computer-controlled studio, something which was currently out of the reach of many institutions but that it was hoped would be a possibility in the near future. A draft of a response from the Studio working group at Radio Belgrade includes the specification that, ‘The studio should be designed that its conversion to complete digital control in the future will involve the minimum of modification and redundancy’.¹⁸

Pignon corroborates this, noting that one of the reasons he had approached EMS was that he knew of Zinovieff’s pioneering work in computing. He and Vladan Radovanović were both excited by the possibilities of computer-controlled music in numerous respects – practically, aesthetically and conceptually. As the Electronic Studio progressed, he says, ‘Both I and Vladan were constantly on about, “Yes, [synthesizers] are all very well, but now computers are getting so powerful we have to go computerized”’.¹⁹ Attempts to put this into practice were unsuccessful, as we shall see later; however, it is a point of interest that the founders of both EMS and the Radio Belgrade Electronic Studio, at a time when voltage-controlled synthesizers were still being introduced as brand new technology into institutions such as the BBC, were already thinking towards the next development in the field. The design of the Synthi 100, like Zinovieff’s hybrid studio, looked ahead to a digital future that both parties

¹⁶ Geoffrey Bowker and Susan Leigh Star, *Sorting Things Out: Classification and Its Consequences* (Cambridge, Mass; London: MIT Press 1999), p. 295.

¹⁷ RB EMS Archive, 13 October 1969.

¹⁸ RB EMS Archive, March 1970.

¹⁹ Paul Pignon, interview with author, 2017.

regarded with interest and optimism. The Electronic Studio's founders felt confident enough about this continuing relationship with EMS to write, in a supplement to the *Third Program* journal in 1973, that the Studio would be updated in the near future with an EMS digital oscillator bank, 'now being developed at Electronic Music Studios', and a computer, working in connection with the Synthi 100.²⁰

It is not unusual for a manufacturer of a specialist device to work to a commission – for example, as I outlined in Chapter Four, the VCS3 originated from a request from Don Banks. However, the specifications and requirements supplied by Pignon and Velimir Žugic, who also visited EMS and who corresponded with David Cockerell about the development of the Synthi 100's sequencer,²¹ were, firstly, detailed and highly informed, and, secondly, conversant with what was already being done at EMS, demonstrating a shared design and musical philosophy and commonly held technical knowledge. Throughout 1970, EMS worked on developing the new synthesizer, in correspondence with Žugic and Pignon at Radio Belgrade. A detailed pro forma from EMS, sent to the radio station in April 1970, captures the new instrument still at a developmental stage, particularly its sequencer, about which, the writer of the pro forma (likely to have been Zinovieff, although the document is unsigned) cautions, 'the specification must remain tentative until the research and development is complete, and actual examples have been tested'.²²

By the end of 1970, EMS was confident enough about its new design to produce a document announcing the new 'Digitana Professional Electronic Music System', self-described as 'the most advanced and complete electronic music complex in the world'. This document, written for other potential customers, mentioned Radio Belgrade along with the BBC and the University of Cardiff as recipients of the synthesizer's original run – even though the machines were yet to be actually finished. Zinovieff sent a copy of this new document to Žugic and Pignon, pointing out the developments that had taken place since their original discussions, not least the fact that the sequencer had now become a central feature of the synthesizer. With Žugic having visited EMS in November, it seemed that the new system was almost ready to be delivered, and Zinovieff began to make arrangements for it to be shipped to Belgrade in 1971. In July, an EMS engineer called David Evans was sent over from the UK to install the

²⁰ *Third Program*, p. 12.

²¹ RB EMS Archive, 15 August 1970.

²² RB EMS Archive, 15 April 1970.

studio, instead of the Synthi 100's designer David Cockerell, rather to Pignon's disappointment.²³

Pignon's role at the Radio Belgrade Electronic Studio was initially that of a consultant in planning the technical specifications of the Studio and sourcing equipment; this later developed into a studio manager role in which he also took responsibility for running the educational programme at the Studio, while Radovanović took on the role of director. However, as Pignon wrote to Zinovieff during 1970, during the early stages of the Studio's development he still worked as a freelance translator and editor, and, despite his input into the Synthi 100 at the beginning of the commissioning process, he was also not involved at every step of the development and testing of the Synthi 100. When the Synthi 100 was installed in August 1971, he was for the first time able to test it out in detail, and immediately found some discrepancies between the instrument and its specifications, some of which he describes as having been 'wildly optimistic'.²⁴ Drafts of letters from Pignon to Peter Zinovieff and David Evans dated August and September 1971 paint a picture of the new studio's staff, including engineer Zorana Hrašovec – who was to carry out important maintenance and modification work on the Synthi 100²⁵ – trying quickly to get to grips with their new acquisition. Problems ranged from small issues that could be easily fixed with replacement parts or cleaning and refitting components, to more serious problems with drifting pitch and velocity voltages on the keyboard, filters that lacked the capacity to carry out 'narrow band', in other words highly selective, filtering, and most seriously, in Pignon's view, a fault with the logic of the sequencer which meant that it could not reverse a sequence correctly. Pignon wrote to Evans,

...In general none of the 'reverse modes' has any practical (musical) application. It was always emphasized as a major feature of the sequencer that it could be run forwards or backwards. I suspect that until recently nobody was really clear about what happened when it was reversed. No doubt you will develop a new, reversible logic, but we are left lumbered with a non-reversible sequencer!²⁶

²³ RB EMS Archive, 13 August 1971.

²⁴ Ibid.

²⁵ Paul Pignon, interview with author, 2017.

²⁶ RB EMS Archive, September 1971.

Another issue that Pignon raised was a more basic one of communication between the two studios, writing that, ‘Zorana is finding it hard to follow the circuit diagrams and drawings because of the many unexplained abbreviations. In most cases I cannot help her either’.²⁷ He enclosed a list of these abbreviations for EMS’s engineers to elucidate. In the meantime, he and Hrašovec continued their testing, fixing and modifications, in some cases solving a problem between beginning a letter and sending it, including the news that they had fixed a particular issue as a ‘P.S.’. Once the rest of the studio was set up, Pignon was able to increase the efficiency of the sequencer by syncing it up with a tape recorder, so that the sequencer could control the tape recorder. This interface, which Pignon and Hrašovec devised, meant in theory that ‘absolute synchronization’ of the two machines was possible.²⁸ Pignon recalls,

The sequencer was actually driven by the tape recorder, and then you could make sections, take them in sync, and make another section that would be synced automatically onto the tape. So you had to do it bit by bit, and the sequencer was relatively, from today’s perspective, very limited, but hugely powerful for those days.²⁹

The surviving correspondence between Pignon and EMS reminds us that, although he was involved in the design and commissioning of the Synthi 100, his other important role in its creation was in processes of installing, problem-solving, ordering supplementary and replacement parts, and making operational both the Synthi 100 and the rest of the equipment in the studio. Pignon’s role as a co-creator of the Synthi 100 included translating information, not only linguistically and in terms of interpreting the sometimes confusing technical information from EMS, but also between modes of institutional and technical communication, for example warning Zinovieff about the ‘very slow’ bureaucratic process by which RTB ordered new equipment,³⁰ and, it is probable, explaining to colleagues at RTB the idiosyncrasies of EMS. Pignon also

²⁷ Ibid.

²⁸ Paul Pignon, ‘The Radio Belgrade Electronic Studio’, p.181.

⁴⁵⁰ Paul Pignon, interview with author, 2017.

⁴⁵¹ RB EMS Archive, 26 November 1972.

acted as an intermediary between Zorana Hrašovec and EMS, relaying the engineer's concerns about problems with the synthesizer and describing to EMS the modifications and fixes she had developed. In the period immediately following Radio Belgrade's acquisition of the Synthi 100, Pignon, Evans and Hrašovec appear to have worked effectively together, despite some frustrations. During this time, Pignon also began to put together a manual for the Synthi 100 – like the BBC's 'Delaware', it had arrived without one. In fact, at this time an official manual did not exist, so, like Brian Hodgson in the BBC Radiophonic Workshop, Pignon wrote his 'from scratch'.³¹

Here, Paul Théberge's idea, from his study of early synthesizers, of the musician 'making over' the instrument is relevant,³² but still more so is his later writing that develops this concept into a more detailed schema in which the co-creative relationship is not only between the musician and the instrument but between the many components – physical, social, institutional – of what he calls the 'assemblage' of the instrument. In Théberge's reading, this idea is particularly suited to electronic instruments, because they are not 'singular technologies' but are themselves dependent on 'technical assemblages' of other devices such as amplifiers, microphones and so on.³³ As the assemblages of electronic music become more complex, such as in the case of an electronic music studio that contains within it an instrument which is itself an assemblage of parts – a synthesizer – networks of different 'musical-discursive' and 'technical-discursive' assemblages come into play, all of which require careful negotiations in order to 'co-function'.³⁴

Extending Théberge's framework to include the people who operate or work within such assemblages, I propose that it is not only that figures such as musicians, composers, engineers, and so on, who find themselves negotiating across this 'complex nesting of assemblages',³⁵ but that it is the emergence of individuals with a particular combination of skills and background that makes the multiple assemblages of the electronic music studio possible in the first place. In histories of electronic music we repeatedly encounter figures such as Pignon who are able to move between numerous activities including composing, engineering, administrative work, design,

³¹ Paul Pignon, interview with author, 2017.

³² Théberge, *Any Sound You Can Imagine*, pp. 50, 160.

³³ Théberge, 'Musical Instruments as Assemblage', in *Musical Instruments in the 21st Century: Identities, Configurations, Practices*, ed. by T. Bovermann, A. de Campo, H. Egermann, S-I Hardjowirogo and S Weinzierl (Basel: Springer Link ebook, 2017), loc.163–180.

³⁴ Ibid.

³⁵ Ibid.

programming, teaching, production and performance: as I have noted in previous chapters, it is possible to see similar characteristics in Alan Sutcliffe, Tristram Cary, Brian Hodgson and, in many instances, Peter Zinovieff. Such figures display flexibility in their chosen roles; they also have characteristics described by Bowker and Star as ‘marginal’.³⁶ This does not mean they are marginalised or from marginal groups in the political sense that we might mean it in everyday speech or in discussions about identity, but refers instead to people who are members of more than one community of practice and who are thus able to ‘naturalize the same object differently’³⁷, in this case, a new technological object which is imperative that a number of different users are able to form a relationship with or at least gain enough understanding of to support its use, even if they do not use it themselves. Communicating between and within the different creative and technical communities of practice associated with electronic music, marginal figures populate and extend the ‘map of mediations’ that John Tresch and Emily Dolan plot from the starting point of the instrument in their formulation of a new organology (see Chapter Four).³⁸ In the following sections I consider some of the other connections across institutional, educational and artistic networks that Pignon and the Studio’s director Vladan Radovanović cultivated in the development of Electronic Studio.

6.3 The public presence of the Electronic Studio

In 1972, as the numerous technical issues accompanying the new Synthi 100 continued to be addressed, the Electronic Studio was officially opened. The following year a programme of composition and education began. Like many other postwar electronic music studios, the Electronic Studio at Radio Belgrade was housed in a national broadcasting facility, but from the outset it was primarily intended to be a centre for the composition of electronic concert music, with very few requirements to compose cues, jingles and sound effects for radio programmes. Some of these tasks did fall under the Electronic Studio’s remit but, as Pignon recalls, the demands for such jobs were low.³⁹ As the notes to a record of music from the Electronic Studio

³⁶ Bowker and Star, p. 303

³⁷ Ibid.

³⁸ John Tresch and Emily Dolan, ‘Toward a New Organology: Instruments of Music and Science’, *Osiris*, 28 (2013), 278–298 (p. 292).

³⁹ Paul Pignon, interview with author, 2017.

released in 1977 stated, ‘The Studio’s primary purpose is to enable the composition of autonomous electronic and synthetic music and of “sound drama” based on words’.⁴⁰

Another important role that the Electronic Studio’s founders had committed to undertake was that of providing courses and residencies for music students and for more established composers, some of whom were local to Belgrade, others visiting from other Yugoslavian republics and elsewhere in Europe. An introductory course was offered free of charge to students in the Faculty of Music at Belgrade University, and gave a grounding in electronic music theory and practice, covering ‘electricity and electronics, acoustics and electroacoustics, familiarization with the hardware, and basic practices and procedure’.⁴¹ Pignon noted in 1974 that a fortnightly seminar series had also been started, in which students could present their work. These meetings, he wrote, ‘will fulfil an important function in gathering together all those connected with the Studio and in molding a general physiognomy of the Studio’.⁴²

Visiting composers could come to the studio for a short residency, rather than undertaking the course. Working alongside these composers, some of whom had little to no experience of electronic music, and none of whom would have used a Synthi 100 before, Pignon and Radovanović helped them realise their ideas, often being credited as ‘co-authors’ on recordings and concert programmes as a result. Pignon recalls,

In those cases, either I or Vladan would be their assistant because they couldn’t come there for a month and learn the Synthi 100 and do a piece, they had to have someone to help them do it. But the teaching courses would go on for quite a long time, and then once the students had done the course they could get studio time and work on their own pieces.⁴³

Early visitors included the Polish composers Bogusław Schaeffer and Andrzej Dobrowolski, whose compositions from the Electronic Studio were

⁴⁰ Sleeve notes, *Elektronski Studio Radio Beograda* (PGP RTB, 1977). We can understand this to mean ‘radiophonic’ works as in the definition supplied by Leigh Landy as ‘the use of radio as a medium of art’ in which, despite interesting and inventive use of sound, ‘conceptual originality’ is the primary consideration. Landy, *Understanding the Art of Sound Organisation* (Cambridge, Mass: MIT Press, 2007), p. 11.

⁴¹ *Third Program*, p. 9.

⁴² Paul Pignon, ‘The Radio Belgrade Electronic Studio’, p. 186.

⁴³ Paul Pignon, interview with author, 2017.

performed at the Belgrade Music Festival (BEMUS) in 1974.⁴⁴ This festival, which had started in 1969, began in 1974 to include a programme specifically dedicated to music from the Electronic Studio. The first of these programmes included, as well as Schaeffer and Dobrowolski's works, Pignon's *Hendrix*, one of the earliest pieces to be made at the Electronic Studio, along with works by two well-known older figures, Slovenian composer Josip Kalčić and Croatian composer Natko Devčić (both co-authored by Vladan Radovanović); and *14 Days After* by Dutch composer Frits Weiland.⁴⁵ From this programme it is possible to detect: the interest in the Electronic Studio shown by composers from across Yugoslavia who had no similar local facilities; the growing interest in electronic and other avant-garde musics in Yugoslavia among an older as well as younger generation of composers; the central roles taken by Pignon and Radovanović as co-creators of electronic works; and the international contacts that had been established by Radovanović, who had visited both the Institute of Sonology in Utrecht, where Weiland was based, and the Polish Radio Experimental Studio, of which Schaeffer was an early user. In the following section I elaborate on some of these topics, providing a brief account of the development of avant-garde musical styles in postwar Yugoslavia and the importance of events such as BEMUS and the Zagreb Music Biennial. I also consider how the music, artworks and philosophies of Vladan Radovanović developed within this context.

6.4 'Indirectly forbidden': electronic music in Yugoslavia

The development of electronic music in Yugoslavia was impeded to some extent by a short period of cultural isolation and instability immediately after the Second World War. Steps that were being taken towards modernist ideas in music were retracted or slowed as composers were briefly encouraged to write in a 'national' style influenced by the music of the Soviet Union.⁴⁶ As Melita Milin writes, this initial period was

⁴⁴ Schaeffer and Dobrowolski's works composed in the Studio were also played at the Warsaw Autumn Festival in 1974, as a record released by the Warsaw Festival shows (*XVIII Warszawska Jesień*, Polskie Nagrania Muza).

⁴⁵ BEMUS Archive. The location for the Electronic Studio concerts was the Student Cultural Centre of Belgrade University, known as SKC (Studentski Kulturni Centar), established in 1971, which became an increasingly important location for art in the 1970s, hosting exhibitions, performances and screenings in its gallery, Galerija SC. The SKC had a regular concert programme divided into performances of classical, traditional and what was termed 'modern' music, and in the later 70s and early 1980s would be an important location for minimalist composers in Serbia.

⁴⁶ Jim Samson, *Music in the Balkans*. (Leiden: Brill, 2013), p. 474-5.

short lived, due to Yugoslavia's 'unaligned' status after Tito's split with Stalin in 1948, and the barrier between Yugoslavia and Western European countries 'was not as strict and impermeable as was that in most communist countries at the time'.⁴⁷ However, although the Yugoslavian government in practice imposed very few restrictions on what music was composed and performed, it was still the case that, for those such as Vladan Radovanović, who was born in 1932, musical developments taking place elsewhere in Europe were less accessible than they had been to Serbia's pre- and interwar generation of composers, who had had more opportunities to work and study in other cultural centres in Europe, in particular Prague and Paris.⁴⁸ But for those wishing to pursue electronic music beyond a very basic level, going abroad remained the only option until the Radio Belgrade Electronic Studio opened in 1972. A concert of 'Electronic music of Yugoslavian authors' at the 1969 Zagreb Music Biennale illustrates this lack of local resources, as it features three electronic works by Yugoslavian composers that had been created at INA-GRM in Paris (Janez Matičič); at the Columbia-Princeton studio in the US (Natko Devčić); and at the Experimental Music Studio Of Czechoslovak Radio in Pilzen, in the Czech Republic (Ludmila Frajt).⁴⁹ Radovanović, who since the 1950s had wanted to work with electronic sound, had been able only to conduct fairly rudimentary experiments, such as *Invencije* (1960), which was composed at home with a portable tape recorder.⁵⁰ Otherwise, like the composers mentioned above, he had travelled abroad, visiting the Polish Radio Experimental Studio in Warsaw in 1966 and returning with a composition called *Elektronska Studija [Electronic Study]*.⁵¹ In his *International Electronic Music Catalog* Hugh Davies includes this work in a short list of electronic compositions from Yugoslavia that he categorises as having being made at, or for, Radio Belgrade; the list also includes a piece for symphony orchestra and tape by Aleksandar Obradović, and an 'improvisation for organ' by Josip Kalčić, indicating that the radio

⁴⁷ Melita Milin, 'Cultural Isolation of Yugoslavia 1944–1960 and its Impact on the Sphere of Music: The Case of Serbia', *Musicological Annual*, 51: 2, 149–161 (p. 150).

⁴⁸ Milin, p. 192; Samson, p. 475

⁴⁹ Erika Krpan, *Muzički biennale Zagreb, 1961–2001/The Zagreb Music Biennale, 1961–2001* (Zagreb: Croatian Composers' Society), p. 129.

⁵⁰ Radovanović's 1960 work *Invencije* is thought to be 'the earliest attempt at editing recorded sound material in Serbian music' (Biljana Srećković, 'Vladan Radovanović: *Phonoverse – Electroacoustic Music*, p. 110); and it is one of the earliest known examples of musique concrete in Yugoslavia, with Croatian composer Branimir Sakač's *Tri Sintetkse Poeme [Three Synthetic Poems]* having been composed in 1959.

⁵¹ The score of *Elektronska Studija* can be seen at http://www.vladanradovanovic.rs/07_elektronska_studija.html

station was at least somewhat receptive to experimental techniques and works that used electronic elements.⁵²

In 1959 the Serbian musicologist and composer Dragutin Gostuški wrote that electronic music ‘is indirectly forbidden because practically there are no conditions for its creating.’ Gostuški commented, with ironic fatalism,

If dodecaphony is one step towards the contemporary, electronic music is at least two steps, and it seems [that] it has bigger perspectives and more useful applications. If music has to be mechanised, it is really better than that it becomes mechanical at once.⁵³

Gostuški’s attitude towards modernist developments in music such as serialism and the use of electronic technologies was not unusual, particularly among older composers and critics; neither was his linking together of twelve-tone and electronic music as steps towards the automation of music. As the musicologist Zija Kučukalić noted in 1971, the prevalent tendencies in Serbian music were still the neo-classicism of Gostuški among others; and socially engaged music for film and theatre.⁵⁴ What Jim Samson in his study of music in the Balkans terms a ‘moderate modernism’ prevailed through the late 1950s and 1960s in Serbia, as it did in the other Yugoslavian republics, exemplified by composers such as Ljubica Maric, who combined some modernist techniques with motifs from traditional and medieval music.⁵⁵

While this status quo began to change during the 1960s, as Davies’s *Catalog* entries for Belgrade and Zagreb show, Radovanović’s preoccupations with unusual timbres, intermediality, flexible or open scoring and electronic treatments were certainly not typical and he was, according to some writers, regarded as somewhat unusual. Milin writes that his music early on was sometimes dismissed as ‘bizarre’ and Ivana Medić likewise paints him as an outlier, referring to a composer whose output was often ‘overlooked and sidelined’ as his compositions belonged to the

⁵² Hugh Davies, *Répertoire international des musiques électroacoustiques / International electronic music catalog*. (Paris & Trumansburg, NY: Groupe de Recherches Musicales de l’ORTF & Independent Electronic Music Center, Inc., 1968), p. 113.

⁵³ Gostuški quoted in Milin, p. 156.

⁵⁴ Zija Kučukalić, ‘Contemporary Trends in Yugoslav Music’, *International Review of the Aesthetics and Sociology of Music*, 2 : 2 (1971), 271-273.

⁵⁵ Samson, p. 477.

‘undestined avant-garde’⁵⁶. This assessment seems exaggerated when applied to a composer who, as well as directing the Electronic Studio from 1972 to 1999, held a staff position at the prestigious Stankovic Music School in Belgrade, exhibited his art in Belgrade and Zagreb, had his compositions broadcast on the radio and performed at important national and international festivals, and won prizes for his music, art and writing. However, it is Radovanović’s tendency to combine various disciplines in one body of work – what Medić has also called his ‘synthesic art’ – that she regards as not having been given enough recognition, both in Yugoslavia and internationally.⁵⁷

There was a more receptive attitude to developments in contemporary music among Croatian composers in the 1950s and 60s. Two of Croatia’s best known postwar composers, Ivo Malec and Milko Kelemen, studied in Paris and formed strong connections to cities and studios outside of Yugoslavia, making contacts which Kelemen drew upon when establishing the International Biennial of Contemporary Music which took place for the first time in Zagreb in 1961. Milin affords great significance to this festival, which was set up with the aim of creating an event similar to the Warsaw Autumn Festival in Poland, writing that it accelerated the development of contemporary music in Yugoslavia, inspiring composers to move towards a post-serial avant-garde that included improvisation and electronic music.⁵⁸ Meanwhile Mirjana Veselinović-Hofman claims that the Biennial helped to increase the ‘media multivalence’ of Yugoslav music, creating possibilities for composers such as Radovanović who were interested in expanded ideas of composition that also included text, electronic sound, performance and visual elements.⁵⁹

The Biennial’s programmes from the 1960s and 70s bear out these claims for its importance, as well as demonstrating a commitment to forging links with international institutions and ensembles of new music from locations including the UK, Sweden, Argentina, France, Germany and The Netherlands. Jazz and improvised music became part of the programme throughout the 1970s, with concerts by artists such as Cecil

⁵⁶ Ivana Medić (née Janković, ‘The Impossible Avant-Garde of Vladan Radovanović’, *Musicological Annual* 55: 1 (2018), 157–176 (p. 157). A coining from philosopher Milorad Belančić, the term ‘undestined’ is a literal translation of the Serbian ‘nesuđena’.

⁵⁷ Ivana Janković, ‘Vladan Radovanović’s Synthesic Art’, *Muzikologija* 3 (2003), 141–186.

⁵⁸ Milin, ‘Serbian Music’, p. 79

⁵⁹ Mirjana Veselinović-Hofman, ‘Problems and Paradoxes of Yugoslav Avant-garde Music: Outlines for a Reinterpretation’ in *Impossible Histories: Historic Avant-Gardes, Neo-Avant-Gardes, and Post-Avant-Gardes in Yugoslavia, 1918–1991*, ed. by Dubravka Djurić and Miško Šuvaković (Cambridge, Mass: MIT Press, 2003), p. 426.

Taylor and Art Ensemble of Chicago appearing on the bill. Opera and dance productions were regularly staged, as well as performances by experimental ensembles such as the Zagreb-based group Acezantez. From the late 1960s, electronic music was featured regularly, and each edition of the Biennial between 1973 and 1981 included a concert presenting works that had been created at the Radio Belgrade Electronic Studio. Radovanović also took part in panels and symposia about electronic music and even managed to stage a retrospective exhibition of his mixed-media – described in the programme as ‘Audio-video-verbo-voco’ – artworks from 1950–79 as part of the 1979 Biennial.⁶⁰

Radovanović was keen from the start that the Electronic Studio would have a relationship to the wider culture in Belgrade and beyond, writing that such a space should ‘become[s] a centre of radical influence in the context of musical culture and creativity’;⁶¹ it also helped him extend his own activities and influence considerably. In the following section I give a brief account of how Radovanović’s varied interests and concerns – combining both visual art and music – influenced the philosophy and aims of the Electronic Studio.

6.5 Thinking in the studio: theory and practice

A member of the art collective Mediala in the late 1950s, Vladan Radovanović was a significant figure during what Miško Šuvaković defines as the ‘neo-avant-garde’, referring to the period from 1950 to the late 1960s in which intermedia art practices began to develop in Yugoslavia, preceding the growth of conceptual art in the 1970s. Defining the neo-avant-garde as a ‘second wave’ of the postwar avant-garde that was characterised in various ways in the different countries and cultural centres of Yugoslavia, Šuvaković describes the Belgrade neo-avant-garde as encompassing art, literature, music and film, and influenced by Fluxus and structuralist literature, writing that, ‘The common ground for various gestures lay in creating a multimedia work of art or a work where the media eluded definition, joining the visual, discursive, acoustic, and existential’.⁶² Radovanović participated in this new milieu not only as a composer interested in ideas such as flexible or open scores and electronic sound, but

⁶⁰ Krpan, p. 168

⁶¹ Vladan Radovanović, ‘The Radio Belgrade Electronic Studio: Philosophy and Aesthetic Orientation’, *Interface* 3: 2 (1974), 169–176 (p. 169).

⁶² Šuvaković, pp. 27–8.

also through a preoccupation with the relationships between language, sound and image, aligning him with the concrete and sound poetry being created elsewhere in Europe at this time. This, of course, also overlapped in some cases with centres of electronic music production, such as in Sweden's Elektronmusikstudion.⁶³

Radovanović produced a number of artworks using texts, including graphic scores, sound poems and two books, all of which advanced his notion of the 'vocovisual', an invented term meaning 'a synthesis of the poetic and the visual' which he explored at length in a book titled *Vocovizuel*.⁶⁴ This interest would continue throughout his career, developing alongside his electronic music and radiophonic compositions, which also frequently used text, speech and the voice. One of Radovanović's best known works in this vein is *The Voice of the Loudspeaker*, made in 1975 and released as a record by the Student Cultural Centre,⁶⁵ which interrogates the role of the recording device in constructing what the listener hears as a human voice.⁶⁶ His electronic compositions as well as his works for acoustic instruments often explored dream states and metaphysical themes, showing an engagement with what he has called the 'cosmic-sacral',⁶⁷ which continued into 1990s works such as *Constellations* (1997). As Samson notes, this direction, which he perceptively likens to that of Stockhausen in terms of esoteric subject matter as well as multimedia presentation, was rare in South East Europe.⁶⁸ Like Stockhausen, too, who wrote and lectured on sonic, theoretical and esoteric aspects of music, Radovanović has for many years been an extremely prolific writer, producing numerous articles outlining his approach to music and art.

Radovanović brought these various concerns and influences to the Electronic Studio, and discussed his aims for the new organisation in various articles in the early 1970s. In one of these, he claims that electronic music has little or nothing to offer the development of conceptual art and vice versa. However, he felt it important to subject

⁶³ see Sanne Krogh Groth, *Politics and Aesthetics in Electronic Music: a study of EMS – Elektronmusikstudion Stockholm, 1964-79* (Heidelberg: Kehrer, 2014); also *Sound Poetry: A Catalogue*, ed. by S. McCaffery and b.p. Nichol (Toronto: Underwich Editions, 1978), pp. 12–13.

⁶⁴ Vladan Radovanović, *Vocovizuel* (Belgrade: Nolit, 1987).

⁶⁵ The composition was performed at the Student Cultural Centre's Festival of Expanded Media in 1975, according to the sleeve notes of the record (Student Cultural Centre/PGPRTB, 1975).

⁶⁶ Daid Crowley, 'Sounding the Body Electric', in *Sounding the Body Electric: Experiments in Art and Music in Eastern Europe, 1957–1984*, ed. by D. Crowley and D. Muzyczuk (Łódź: Muzeum Sztuki, 2012), pp. 87, 91.

⁶⁷ Medić, p. 164.

⁶⁸ Samson, p. 488.

music to some of the same self-examination that conceptualists were bringing to visual art, given that the movements were contemporaneous.⁶⁹ To read Radovanović, writing in 1974, on the ‘Philosophy and Esthetic Orientation’ of the Electronic Studio, is to observe someone thinking through a number of approaches to the aesthetics and practice of electronic music drawn from his knowledge of not only visual arts practice, but also loosely Schaefferian notions of ‘sound objects’⁷⁰ and, relatedly, their ‘sonological’ analysis; and electronic music’s affective, even spiritual dimensions. There are also convergences with some of the ideas and concerns raised by Peter Zinovieff and the various composers and technologists at the 1970 UNESCO conference described in Chapter Three about the automating of musical operations and the authored status of artworks generated by technological processes: what Radovanović calls ‘ownness’.⁷¹

My intention is not to analyse in detail these various strands of thought about what the purpose and direction of electronic music should be, but rather to observe that an atmosphere of musical-philosophical inquiry was being fostered alongside the more technical aspects of composing and producing music at the Radio Belgrade Electronic Studio. I propose that this kind of activity – taking the form of conversations, lectures, essays and so on – not only informs the music that is produced in an electronic music studio but is more generally an important aspect of its operation. These theoretical activities create yet another network, which could be called intellectual-discursive, within Théberge’s ‘assemblage’ model of electronic music.⁷² In this reading, the Electronic Studio is not only a physical place but also a symbolic space in which fundamental questions of aesthetics, authorship, media and technology can be raised.

The clearest aims expressed in the early days of the Electronic Studio can be defined as falling into two main areas, both of which connect with a notion of an aesthetics of electronic music that could encompass various theoretical and practical approaches. The first was to do with plurality. Radovanović claimed,

⁶⁹ Radovanović, p. 170.

⁷⁰ see Schaeffer, P. (1952) *In Search of a Concrete Music*. Translated from French by J. Dack and C. North (2012). Berkeley: University of California Press; also Joanna Demers, *Listening Through the Noise*, p. 82.

⁷¹ Radovanović, p. 170.

⁷² Théberge, ‘Musical Instruments as Assemblage’, loc.163–180.

The philosophy is one of openness to all phenomena, from minimalism to audio-visual-kinaesthetic-tactile projects, a scope which goes beyond the institutional purpose of the studio in that it also involves the problems of non-audio media.⁷³

However, the idea of openness, which was frequently reiterated in written materials produced by and about the Electronic Studio, began at a more fundamental level, before the inclusion of ‘non-audio media’ (which, while of stated importance to Radovanović, appears to have remained fairly low in the Electronic Studio’s actual activities). A description of the Studio’s ‘Esthetic and Theoretical Orientation’ in the *Third Programme* journal – uncredited, but likely to have been co-written by Radovanović and Pignon – made it clear that this ‘declaredly open policy’ was not only an ideological aim but was also contained within the workings of the studio itself. In other words, its technological set-up encouraged a plurality of approaches,

‘...thereby eliminating any gap between electronic music in the strict sense and concrete music. At the level of macro-organization, there are no limits – it can range from extreme simplicity to the maximum possible complexity. The degree of the composer’s control over the organization of material can range from very precise determination of as many parameters as can be controlled to totally stochastic structures. The range of possible approaches to work in the Studio, and hence also of the esthetic and creative results of these approaches, is thus very wide.’⁷⁴

Earlier in this chapter I referred to Bowker and Star’s notion of the marginal figure’s ability to ‘naturalize the same object differently’. Within this model, the Electronic Studio itself becomes such an object that can be perceived and naturalized in different ways, becoming a potential resource for connecting divergent composers, musicians and artists.⁷⁵ Previously I described the way in which Pignon’s different bodies of knowledge allowed him to communicate across different technological and institutional settings, constituting a kind of marginal activity; here we see how a similar pattern emerges in the musical and artistic communities that Radovanović was

⁷³ Radovanović, p. 171.

⁷⁴ *Third Programme*, p. 10-11.

⁷⁵ Bowker and Star, p. 223.

involved in. Both, too, were aware of the importance of the wider international community of electronic musicians of which they were a part and with which the Electronic Studio could play a vital communicative role.

The other main aim of the Electronic Studio concerned sound as a material. Whether this sound material was generated by a synthesizer or taken from a recording, or played by an acoustic instrument and processed, was not the most important factor. The point was to be able to access and work with sound as directly as possible, ‘not ruling out the score but treating it as strictly functional [...] Obviation of the score and parts does not mean that the mediator (performer) disappears – the composer becomes the performer.’⁷⁶ In order to achieve this, the ideal was that the composer should be skilled and confident enough to self-engineer their own compositions. Setting out the aim of the ‘Practical Orientation of the Studio’, Radovanović and Pignon stated a desire that,

Composers should be able to work *independently* (alone) in the studio. The composer who works by himself can achieve a continuity between idea and actualization, as well as direct feedback from sound to idea, such as can never be achieved when he has to work through some kind of objective notation and a realizer.⁷⁷

Reflective of Pignon’s background in physics and knowledge of electronics, and Radovanović’s interest in process-based and media arts, this aim encouraged composers to form a direct, experimental relationship with the studio in which it would become more than just a useful tool for realizing pre-existing ideas. Whether this meant that the technology ‘disappeared’ or became even more present in the work produced is an interesting point that would bear future consideration, particularly when compared to works made through more traditional composer-realiser relationships of the sort I outlined in Chapter Three, such as Zinovieff’s collaborations with Harrison Birtwistle and Justin Connolly – and, indeed, the numerous works

⁷⁶ Radovanović, p. 174.

⁷⁷ *Third Programme*, p. 10-11.

realised at the Electronic Studio that listed Radovanović and Pignon as co-authors.⁷⁸

Having examined the Electronic Studio's ethos of openness and independent working, it is important not to overstate the actual accessibility of Electronic Studio, nor the diversity of its output. The aim of self-engineering was certainly not always achieved, as few of the visiting composers were able to operate the Synthi 100 independently. Rather than attracting interdisciplinary artists, most of the students on the Studio's course came from the Music Faculty at Belgrade University, and were therefore in possession of Western classical music training, while visiting composers from Yugoslavia and elsewhere were also highly educated in classical music. They were often important figures in their field, which was generally not electronic music. Commercially released recordings of music made at the Electronic Studio in the 1970s and 1980s showcased well-established composers such as Ludmila Fraijt, Natko Devčić and Lojze Lebič, introducing only a few younger, less prominent composers.⁷⁹ However, an acknowledgement on the 1983 release that the field had developed and expanded beyond the exercises in 'purely electronic music' created in the Studio's earlier days into experiments in voice synthesis, transformation of acoustic material, and 'multi-medial' productions, among other areas, indicates that the Studio's founders were aware of the important contributions of emerging artists and composers to the increasingly diverse landscape of electronic music practice.⁸⁰

One key way in which the Electronic Studio fulfilled its aim of contributing to the wider musical and artistic culture was through its influence on a group of composers born in the early 1950s. In the later 1970s and early 1980s, Milimir Drašković, Miroslav Miša Savić, Miloš Petrović and Miodrag Lazarov (also known as Leon Miodrag Lazarov Pashu), members of a self-styled, rebellious 'New Generation' who became known for establishing minimalist music in Serbia,⁸¹ all took the electronic music course at the studio while studying at the University. Notably, they also became

⁷⁸ In fact, as Luca Cossettini suggests, with his multi-faceted art practice, Radovanović was particularly well suited to collaborating with other composers and acting as a kind of producer, taking on a 'dual role, which combines the reflective composition moment with the practical-performing moment'. Cossettini, 'Radio as an Art Form in Former Yugoslavia: *Malo Večno Jezero* by Vladan Radovanović at Radio Belgrade Electronic Studio', *Musica & Figura* 5. (2018), 179–198 (p. 186).

⁷⁹ Two albums were released with the name *Elektronski Studio Radio Beograda* (PGP RTB, 1977 and 1983).

⁸⁰ Sleeve notes, *Elektronski Studio Radio Beograda*, 1983.

⁸¹ Veselinović-Hofman, p. 416.

interested in the possibilities of media and conceptual art, with Drašković creating films such as *TV Opera* (1982), and Savić working with durational techniques and performance art. Dragana Stojanović-Novičić notes that these composers would consult with Radovanović, whose ‘concept of new relations and new hierarchies between musical elements’ impacted upon their own work.⁸² For such composers the Electronic Studio would have provided a welcome alternative to what Stojanović-Novičić describes as the traditional learning environment of the University’s Faculty of Music.

With the establishment of the Electronic Studio, Radovanović was able to actualize his own distinctive ideas about sound, music and technology, and establish a base for electronic music in Yugoslavia. In the following section, I will provide brief accounts of some compositions created at Radio Belgrade, considering how both the technological makeup of the studio – centred around the Synthi 100 – and the philosophies of its founders influenced the work that was created there.

6.6 Composing with the Synthi 100

How did the Synthi 100 help to facilitate Radovanović’s aims for the Studio to become a place where composers could work ‘directly in sound’? And how did it help composers address the issues of what Radovanović calls ‘ownness’ – the composer’s capacity to make musical decisions – and control, that is to say, the relationship between a composer’s musical idea and its realisation by a machine? It was clear that, with its capacity to generate and store complex musical patterns, the new synthesizer promised to be more than just, as Radovanović puts it, a ‘vast instrument’ containing a large library of sounds: it also could be a kind of environment in which sonic material ‘organises itself’.⁸³ Works produced at the Electronic Studio in Belgrade demonstrate a number of ways in which the Synthi 100’s possibilities were explored, for example in investigating the variety and variability of sound; using the synthesizer to emulate acoustic instruments or natural sounds; creating complex layered compositions using the sequencer; playing with ideas of automated, self-perpetuating processes – what we might now call ‘generative’ music – and conducting experiments involving live

⁸² Dragana Stojanović-Novičić, ‘Musical Minimalism in Serbia: Emergence, Beginnings and its Creative Endeavours’, in *The Ashgate Research Companion to Minimalist and Postminimalist Music*, ed. by K. Potter, K. Gann and P. ap Siôn (Farnham: Ashgate, 2013), p. 360.

⁸³ Radovanović, p. 172.

performance and processing of the voice and other instruments. These varied uses challenge the notion put forward in the previous chapter that the introduction of synthesizers into electronic music resulted in homogenous, less inventive music compared with previous tape-based methods. While this might have been the case to some extent at the BBC Radiophonic Workshop, the Radio Belgrade Electronic Studio demonstrates that within a more experimental and inquiring environment, the same device could be used to explore complex sonic and musical paradigms.

6.6.1 Dialogues between sound worlds

As we have seen in Chapters Four and Five, the imitative capabilities of synthesizers were promoted widely when they first became commercially available. Their capacity to make sounds ‘like’ acoustic instruments or natural phenomena were clearly useful for manufacturers who wanted to put forward the idea of the synthesizer as a substitute for live instruments, Foley sound or library recordings of, say, wind or sea. As Chapter Five describes, this notion of the synthesizer as a one-stop solution for musical and sound effects needs was also useful in persuading the BBC Radiophonic Workshop’s Technical Committee to invest in EMS’s VCS3s and Synthi 100.

The composers working with the new Synthi 100 at the Radio Belgrade Electronic Studio were also interested in the way in which sounds that were similar to acoustic instruments, including the voice, were able to be generated by the Synthi 100, but the thinking behind the imitative aspects of compositions such as Radovanović’s *Elektra* (1973) and, later, *Audiospacial*, a work for choir and electronics, was analytical and discursive, trying to generate dialogues between acoustic and electronic sound rather viewing the Synthi 100 as a sonic replacement for acoustic instruments or pre-voltage control electronic processes.

Elektra was one of the earliest pieces composed by Radovanović in the Electronic Studio. Structurally it juxtaposes passages of contrasting sound material: for example, clusters of pitched notes with timbres not dissimilar to organs or wind instruments, long tones treated with vibrato that imitate a solo voice, and clearly synthetic-sounding staccato patterns that are likely to have been created using the Synthi 100’s random voltage generator, which are repeated, modulated, sped up and slowed down. As the piece progresses, the more naturalistic sounds are altered in various ways, including extensive use of envelope filters, demonstrating the way in which electronic

techniques can analyse, manipulate and draw attention to certain properties of the sound spectrum that are hard to perceive by other means. The overall impression of the piece is that it sets out situations in which the synthesizer evokes instrumental or vocal music and then disrupts this impression, to create a state of disorientation in which the listener questions their perception of what they have heard. Radovanović developed this idea to greater effect in a later work titled *Audiospacial* (1975–1978), for choir and electronics, in which the qualities of the human voice and the synthesizer are explored for their convergences. In this piece, singers were encouraged to explore the ‘electronic’ qualities of their voices, as well as the electronic elements simulating voices, and so there feels to be a more dynamic communication and synthesis between the different sound worlds. In *Elektra*, however, Radovanović mainly explores the Synthi 100 as a set of instruments or sound types, testing their properties and limits and their effects upon the listener.

Josip Kalčić’s *Duboki Do [Deep Valley]*, which was also composed in the early 1970s, makes use of imitation far less conceptually and more as a means of evoking a specific place and time. Kalčić – a Slovenian composer who was born in 1912, and known more for symphonic orchestral works and cantatas – uses the Synthi 100 to generate ‘birdsong’ and other natural sounds that, according to the composer, are intended to bring to mind the countryside around the Danube.⁸⁴ This premise for a composition is rooted in Impressionist or even Romantic traditions of music inspired by nature; it is also, in its dramatic structure, not dissimilar to a radiophonic production, as many of the electronic sounds are clearly meant to represent ‘real’ sounds, and the composition follows a fairly clear narrative whereby nature is encroached upon by urbanization and industry – sonically represented in machine-like sounds and use of distortion, ring modulation and noise. Ludmila Frajt’s *Nokturno* (1976) likewise explores the capacity of the Synthi 100 to imitate natural sounds, creating a kind of ‘soundscape’ of a night. These rather cinematic compositions are in some ways far less experimental or conceptually interesting than those of composers such as Radovanović, yet they have an appealing, somewhat poignant quality that has to do with a tension between the simplicity of what they are trying to achieve – evoking the feeling and atmosphere of a place and time – and the complex, painstaking and unfamiliar means by which the composers have chosen to realize this

⁸⁴ Sleeve notes, *Elektronski Studio Radio Beograda* (PGP RTB, 1977) and *30 Godina Elektronskog Studija Radio Beograda* (PGP RTS, 2002).

aim, which results in an uncanny, ‘posthuman’ effect.⁸⁵ As the synthesizer’s capacity to imitate natural sound or bring to life a personal memory is being tested and exploited by Kalčić and Frajt, the ‘middle between the new and the old timbre’ that Radovanović searches for in his composition, as he wrote in an accompanying note to *Elektra*,⁸⁶ often emerges, perhaps by accident rather than design.

6.6.2 Testing the hardware

As the Studio’s founders wanted to display and make the most of their new Synthi 100, so too did visiting composers want to see what it could do, meaning that a number of the early compositions made on it function also as experiments that test out the different functions and capabilities of the Synthi, focusing on the materiality of the instrument rather than a theme or concept. Two such pieces were made by visiting Polish composers: *S va S* (1973) by Andrzej Dobrowolski and *Synthistory* (1973) by Bogusław Schaeffer. The title of Dobrowolski’s composition stands for ‘Studije va Sinti’ (‘Study for Synthi’), and demonstrated the composer’s intention to adapt his working processes, formed in the tape-based Polish Radio Experimental Studio, to the new technology of the Belgrade Studio.⁸⁷ The ‘study’, which allows the player to practice and demonstrate a specific musical technique or techniques on their instrument, is a staple of classical music repertoire. However, there were some immediate differences in what it meant to compose a study for a complicated synthesizer, compared with an acoustic instrument. Firstly, there was no historical repertoire for the Synthi 100, or any synthesizer, to draw on, making the idea of a study, which depends on there being a set of instrumental skills a player needs to master, somewhat ironic: the title alludes to musical tradition in which the synthesizer had no place. Secondly, while Dobrowolski worked with Radovanović to realize his piece, it required him to at least partially become a composer-performer, as well as a temporary student, learning how to use the Synthi as he composed. Finally, there was the fact that learning to use the Synthi did not mean accessing a history of performance techniques and styles for an instrument, but learning to construct and adapt the instrument itself. This principle of constructing the instrument seems to have

⁸⁵ cf. N. Katherine Hayles, in her writing on the interactions of bodies, information and machines, *How We Became Posthuman: Virtual Bodies in Cybernetics, Literature and Informatics* (Chicago: University of Chicago Press, 1999).

⁸⁶ Radovanović, *Fonoverzum* (GOD Records, 2010, 2016).

⁸⁷ Released on the CD *30 Godina Elektronskog Studija Radio Beograda* (PGP RTS, 2002).

been fundamental to Paul Pignon's understanding of the Synthi and therefore would have been transmitted in his teaching and support of visiting composers. He uses the following analogy:

Of course [the Synthi 100] doesn't do anything until you build something, so to speak, so nothing there is ready made. You build your musical instrument, your composing tool for your particular piece you want to work on ... You don't just write for the orchestra, you build the orchestra first.⁸⁸

In practice, numerous settings and patches for certain kinds of frequently required sounds and operations would have been recorded and written down for new users to follow. As more compositions were made in the Electronic Studio, a library of existing instruments – in other words a library of patch diagrams and control settings – began to build up: Pignon noted that 'composers are required to make such diagrams and leave a copy in the Studio'⁸⁹. However, these were used mostly as starting points for the construction of new patches, rather like altering and re-saving a preset on a digital instrument. This process, too, was one of construction and engagement with the make-up of an instrument that brought considerations of hardware to the fore.

The title of Pignon's *Hardware Performance*, one of the very first compositions to be made at the Electronic Studio, both positions the performer as someone who uses 'hardware', and positions the hardware as a performer in its own right. It thus reframes the word 'performance' as something other than musical, reminding us that many electronic and mechanical devices are spoken of as 'performing', whether that is a computer performing a function or when talking about how a car performs on a test drive. The piece grew from the months of testing, debugging and fixing the Synthi 100 that Pignon carried out after it was installed and so, like the others in this section, it presents a kind of demonstration of the instrument, exploring different functions and properties, as well as prefiguring his later, 'organic' works, which I will talk about in the next section.

⁸⁸ Paul Pignon, interview with author, 2017.

⁸⁹ Pignon, 'The Radio Belgrade Electronic Studio', p. 183. At the time of writing, I have not been able to locate the 'patch library' mentioned in 1974. Pignon himself had kept very few of his own patches, but at the time of our interview was trying to locate as many as possible in order to assist with the research and education work going on at the Electronic Studio.

Hardware Performance is in three parts, with each movement purporting to ‘inhabit[s] a different subspace of the available sound universe’.⁹⁰ In practice, although it is possible to hear certain groups of sounds more prominently in some sections than in others, and there is a timbral logic around which each movement is structured, how these ‘subspaces’ are characterized sonically is not the most important aspect of the work. What is more interesting is the way in which different functions of the Synthi 100 are used in each movement and the potential of different kinds of relationships between sounds and structures to be established across the instrument. In contrast to the rather taxonomic approach of the compositions in the previous sections, in which the aim seems to be to carefully create and arrive at certain sounds, which then become the focal point of the work, Pignon’s composition emphasizes relationality, transformation and movement.

The term ‘performance’ and Pignon’s other activities as an improvising musician lead us to expect an improvisatory quality to the composition, which is heard in the Third Movement with what sound like improvised manipulations of noise generators and filters; however, much of the piece is heavily layered and overdubbed, using the sequencer’s three layers plus the tape recorder which Pignon had synced to the Synthi 100. While the Synthi 100 made it possible for ‘all parameters [of pitch, duration, tempo and so on] to be manipulated in *real* time’, to borrow Karlheinz Stockhausen’s enthusiastic description,⁹¹ it also made possible the extensive manipulation of pre-recorded, programmed material. This is not to say that improvisation cannot incorporate those elements, more that in works such as *Hardware Performance*, and indeed Stockhausen’s *Sirius* (1973), notions of liveness, improvisation and performance itself are challenged, adding further complexities to definitions of electronic music as a performance medium and the studio as a space in which performance as well as recording, editing and mixing take place. While *Sirius* uses the transformation of melody rather than timbre as a structuring principle,⁹² it is likely that the realization of the two pieces took place under similar circumstances, using live

⁹⁰ Sleeve notes, *30 Godina Elektronskog Studija Radio Beograda* (PGP RTS, 2002).

⁹¹ Karlheinz Stockhausen, *Stockhausen on Music: Lectures and Interviews Compiled by Robin Maconie* (London: Marion Boyars, 1989), p. 131; emphases in original.

⁹² Robin Maconie, *Other Planets: The Complete Works of Karlheinz Stockhausen*. 2nd edn. (Lanham: Rowman & Littlefield, 2016), p. 324.

manipulation of the Synthi's crossfaders and joystick to morph between sequences and then editing the studio performance to tape.⁹³

Hardware Performance was made using only the sounds of the Synthi 100; however, Pignon was, in his estimation, one of the few users of the Studio who also used it in conjunction with acoustic instruments, feeding sounds from a clarinet or saxophone into the Synthi and using the frequency to voltage converter to control patches, so that the machine would respond in real time to his playing.⁹⁴ This was another way in which the hardware could become a performer, controlled by but also entering into dialogue with the instrumentalist.

The pursuit of 'real time' electronic composition motivated many composers and engineers at this time, including the founders of the Electronic Studio. The framing of the Studio as a place of performance, in which improvisatory gestures and live processing of sound, including the increasingly precise parameter-based processing afforded by the sequencer and tape recorder, all worked towards this ideal, in which it would be possible, as Stockhausen writes, 'to *realize*, and *hear* and *experience* and *influence* the composition of multiple time-layers during the act of composition'.⁹⁵ The notion that the human musician was not the only performer in this process is explored further in the following section.

6.6.3 Automated processes and organic machines

In his 1974 paper on the 'equipment and procedures' of the Electronic Studio, Pignon attests to the Synthi 100's potential to expand the possibilities of electronic composition, which he attributes to the patching system and the integrated sequencer. He writes that, due to these features,

The composer can *begin* [original emphasis] to explore new domains of compositional strategy not generally associated with the synthesizer concept, which has so far...been oriented to facilitating the implementation of a 'classical electronic instrument' type of philosophy. For this reason I would class the Synthi 100 (especially when interfaced with

⁹³ I am indebted to Sean Williams for his insight into Stockhausen's studio performance processes. Conversation with author, 2018.

⁹⁴ Paul Pignon, interview with author, 2017.

⁹⁵ Stockhausen, p. 131. Emphases in original.

the 4-track T/R [tape recorder]) as a more advanced device than a synthesizer as this term is generally understood.⁹⁶

One of these ‘new domains’ was Pignon’s development of what he calls, variously, ‘musical automata’, ‘organic machines’ or ‘zoetic’ compositions, that is to say generative music made possible by the complexity of the patching options on the Synthi 100, in which a process can be set up and continues to develop without repeating, using random generators and timers as triggers and, if desired, controlling some aspects of the performance in real time. Referring both to the Belgian composer and instrument builder Leo Küpper and the computer generated compositions being created at EMS by Peter Zinovieff as points of reference, Pignon wrote, ‘one has the opportunity to explore the manifold of system trajectories resulting from a given control’.⁹⁷

As the decade progressed, Pignon completed a number of pieces composed using this principle, including *Microhabitat* (1976), and in c.1980 a playful composition called *Mechanical Cartoons*, in which four electronic ‘voices’, which are vaguely anthropomorphic, appear to converse and interact with one another without at any point forming a coherent rhythm or melody yet hinting at a shared underlying structure. Each of these voices is the sound of one ‘machine’, each constructed so that it can play for a certain length of time without intervention from the composer, although in this case, Pignon told me, ‘I’m putting some input with the joystick just to guide a bit. They’re [the machines] kind of living their own lives but I’m pulling the reins a bit, so to speak’.⁹⁸

These compositions exploit the Synthi 100’s capacity to generate a seemingly infinite number of sonic and structural possibilities and highlight its extreme versatility as an analogue synthesizer that could be configured in multiple and complex ways. They are clearly important to Pignon as a composer, representing some of his most enjoyable and complex experiments with the Synthi 100; however, their conception and execution are also of interest for the way they prefigure digital interfaces, programs and performance environments that are used for live electronic music in the present day, as I will describe in the following chapter on the restoration

⁹⁶ Pignon, ‘The Radio Belgrade Electronic Studio’, p. 182.

⁹⁷ Ibid.

⁹⁸ Paul Pignon, interview with author, 2017.

of the Synthi 100 and its use as a ‘live’ instrument. In response to my question about the similarities between the Synthi 100’s patch matrices and modern digital interfaces, Pignon makes this point:

You could say that the patching you can do in Pure Data and Max is like – now you can do it on your computer screen, but you could do something very similar on the Synthi 100, physically, much more than you could do with the cord-patched synthesizer. You’d just run out of cords and holes – but on the Synthi 100 you don’t really, and nor do you with Max or PD. You can connect any number of things forever.⁹⁹

In a recent article, however, he has written, ‘The latter-day patching techniques I started to develop in the 80s [...] involve unorthodox, “impermissible” connections, giving rise to unstable feedback configurations which just don’t work in the digital domain.’¹⁰⁰

6.7 Conclusion

In this chapter I have told the story of the founding of the Electronic Studio at Radio Belgrade, noting how the working group at the broadcasting station worked with the EMS to design, manufacture and install the Synthi 100. Through combined technical expertise and shared ideas concerning the future of electronic music technologies, the two organizations can be said to have collaborated on the invention of the Synthi 100, and its creative and sustained use at Radio Belgrade bears out some of the claims EMS initially made for the Synthi 100, when they presented it as an instrument offering ‘limitless’ possibilities.

I have also shown how, through a commitment to experimentation, plurality of approach and education in studio techniques, plus an awareness of current discussions in electronic music and other art forms, the Electronic Studio at Radio Belgrade developed a profile as one of the important centres for electronic music in Eastern Europe. The readiness of Vladan Radovanović to set out aesthetic as well as practical aims for the Studio is explored as an example of how ideas interact with technologies to activate spaces of electronic music and sound and how this discursive realm can be

⁹⁹ Ibid.

¹⁰⁰ Paul Pignon, ‘Why I still Want to Make Music on the Synthi 100’, in *INSAM Journal of Contemporary Music, Art and Technology*, 3, 2 (December 2019), 15–18.

considered alongside other networks – music, technical and so on – when thinking about a studio through Théberge’s framework of the ‘assemblage’.¹⁰¹

Giving an account of a small number of compositions from the Studio I consider how the nature of the Synthi 100 and the Studio as a whole made it possible for those compositions to be realized; in this way, I propose the Synthi 100 did not only benefit electronic musicians in Yugoslavia but it actually made the formation of a body of electronic music possible. Using a methodology of descriptive, sonically focused writing (see Chapter One), I have tried to understand the thinking behind these compositions and the circumstances in which they were produced, and to show how composers – most notably Paul Pignon – worked with, rather than against, the Synthi 100’s limitations *and* its complexity, building a lasting relationship with the instrument that continued for many years.

In my concluding chapter I describe the decline and closure of the Electronic Studio in the 2000s, as a preface to the main body of the chapter, which analyses a recent project to restore the Synthi 100 and relaunch the studio. I describe how a space can be reactivated and its history investigated through the restoration and reuse of a historical instrument, drawing together a number of themes running through this study concerning the construction of electronic music histories through media, technologies, practices and relationships between people, machines, institutions and environments.

¹⁰¹ Théberge, ‘Musical Instruments as Assemblage’.



VLADAN RADOVANOVIC, POL PIGNON
ZORANA HRASOVEC I MILAN ORLIC



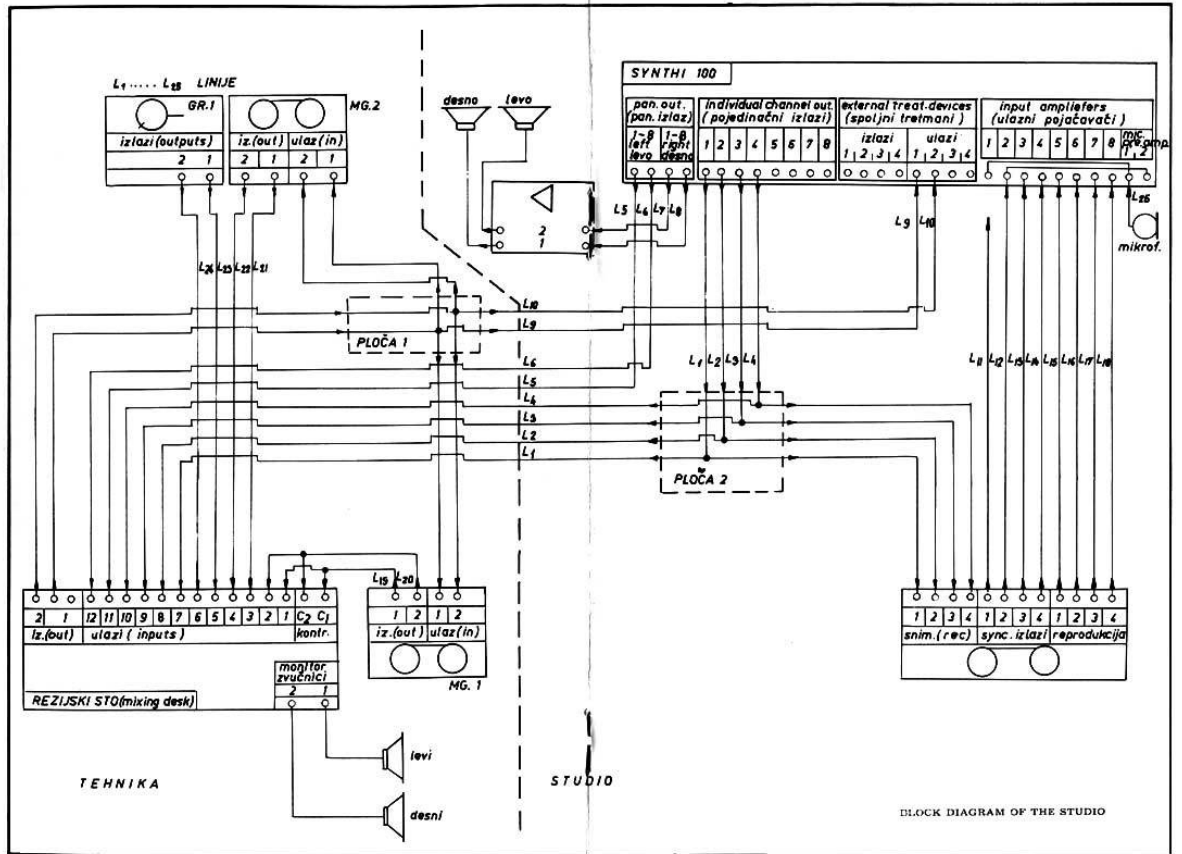

BLOCK DIAGRAM OF THE STUDIO

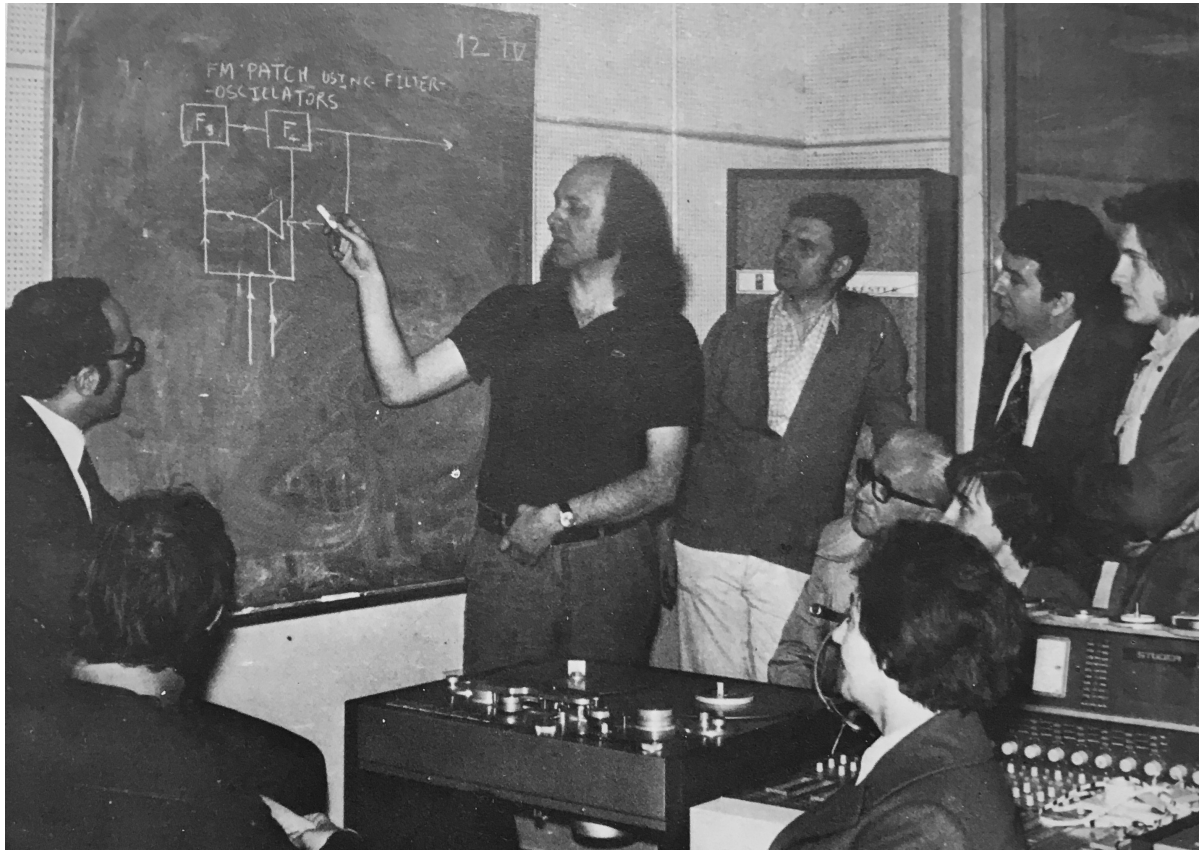

elektronski studio radio beograda

radovanović pignon devčić kalčić



Chapter 7

From studio relic to performance instrument: new presentations of the EMS Synthi 100

7.1 Introduction

In this chapter I propose that aspects of histories of electronic music can be constructed and viewed through the restoration and re-presentation of electronic musical instruments, via an account of restoration projects concerning the Synthi 100 at Radio Belgrade and CMRC-KYSME in Athens. As in Chapter Six, much of the research in this chapter took place remotely; it is hoped that in a future study a more embedded period of fieldwork could be carried out at either Radio Belgrade or another institution engaged in a synthesizer restoration project.

This particular project was initiated in 2016 by the Radio Belgrade 3 producers Ksenija Stevanović and Irena Neimarević, both of whom are also musicologists. The aim was to restore Radio Belgrade's Synthi 100 to working order as part of a wider initiative to relaunch the Electronic Studio, at the same time as researching and publicising its history, through activities such as digitizing audio and paper archives, broadcasting programmes about important figures in the Studio's history, and concerts such as the one written about in this chapter.

As mentioned in Chapter Six, artist and composer Svetlana Maraš was invited to run the restoration project, on which she collaborated with two engineers, Jari Suominen and Daniel Araya, as well as with Paul Pignon. In Chapter Six and elsewhere in this study, I have reflected on the various creative and professional roles that have historically been assumed within electronic music studios; here, I bring a similar consideration to the present day, exploring the roles of restorers, composers, artists and engineers within the sometimes interconnected 'networks of reoperationalisation' that have formed around the restoration of Synthi 100s. With reference to computing historian Doron Swade's definitions of various kinds of scientific restoration practice, such as reconstruction, replication and simulation, I propose a similarly taxonomic approach to electronic musical instrument restoration, using oral and written accounts from restorers themselves to demonstrate how the

restoration and maintenance of historic music technologies give researchers important insights into the ‘operational environment’ of an instrument.¹

Through an account of some of the public activities of the Belgrade restoration project, I show how the restored Synthi 100 has become emblematic of the Studio and its history, and has also been presented as part of a narrative of current electronic music practice, situating it as an object through which a dialogue between electronic music’s past and present can be conducted. With reference to the TV programme *Concerts From Studio 6*,² on which the Synthi 100 was featured, I describe how the Synthi 100 has been repositioned as a performance instrument with which new compositions can be played ‘live’, thus expanding the definition of the Electronic Studio so that it becomes a place for public performance. I explain how this expanded definition is made possible partly through technical strategies from current visual cultures of electronic music. These new presentations of the Synthi 100 suggest a possible response to the key question asked by Austrian musician and artist Elisabeth Schimana of her ongoing work with the Max Brand synthesizer, an early synthesizer invented by Robert Moog and composer Max Brand in 1957-8: ‘What is in such a machine that has not yet been experienced?’³

I discuss this and other aspects of the restoration project through readings in media archaeology, a discipline with which Schimana is associated,⁴ but also returning briefly to James R. Griesemer and Susan Leigh Star’s concept of the boundary object, which I introduced in Chapters Five and Six, by considering what kinds of new boundary characteristics, ‘translations’ and ‘residual categories’ are created in the restoration of an historical instrument,⁵ particularly when, as in the case of the Belgrade Synthi 100, it takes on the status of a protected heritage object within institutions of national media and museums of science and technology, while at the same time being used to create new music in combination with new digital technologies.

¹ Doron Swade, ‘Collecting Software: Preserving Information in an Object-Centred Culture’, in *History of Computing: Software Issues*, ed. by U. Hashagen, K-S. Reinhard, and A. Norberg (Berlin & Heidelberg: Springer 2002), 237-244 (p. 231).

² *Concerts from Studio 6*, dir. Nevena Popović, Radio-Television Serbia, March 2018.

³ Elisabeth Schimana cited in Wolfgang Ernst, *Chronopoetics: The Temporal Being and Operativity of Technological Media*, translated from German by A. Enns (London: Rowman & Littlefield, 2016), p. 118.

⁴ Schimana is the founder of the Institut für Medienarchäologie (IMA) (<https://ima.or.at>)

⁵ Susan Leigh Star, ‘This is not a Boundary Object: Reflections on the Origin of a Concept’, *Science, Technology, & Human Values*, 35: 5 (2010), 601–617.

I conclude by considering these various activities that can be defined as restoration, reconstruction, renovation and so on as examples of the *reoperationalisation* of electronic music histories, situating this term within a discussion of the centrality of the term ‘operative’ to media archaeology.

As media theorist Knut Ebeling remarks, processes of archaeology tell us not only about the past but also about the ‘present that demands the search’.⁶ I conclude by considering what it is in electronic music’s present that produces this attraction towards instruments from its past and the drive to restore them – and, finally, asking what we can learn about historic electronic music studios and instrument manufacturers such as EMS from the way in which this process of restoration is envisaged, carried out and publicly presented?

7.2 The demise and revival of the Radio Belgrade Electronic Studio

In 1986 Paul Pignon left Belgrade for Stockholm, where he currently lives and works. One of his reasons for leaving Belgrade was that an opportunity arose to pursue computer music at Stockholm’s Elektronmusikstudion.⁷ Despite its well-funded beginnings, financial support for the Electronic Studio had declined throughout the 1980s and as a result there were few resources to update the equipment there. As Luca Cossettini notes, ‘The Studio was equipped with computers as late as 1987, and even then the equipment was already obsolete: the computer was an Atari Mega ST2, initially without the appropriate software’; a PC running Logic software was eventually added in the mid-1990s, by which time fewer composers were opting to use the Studio.⁸ Despite Pignon and Radovanović’s hopes that the Studio would be equipped with a computer by the mid-1970s, in order to compose ‘the first Yugoslav computer music’ in 1976 and other digital works in the 1980s Radovanović had had to

⁶ Knut Ebeling, ‘The Art of Searching: On “Wild Archaeologies” from Kant to Kittler’, *The Nordic Journal of Aesthetics*, 51, 7–18 (p. 17).

⁷ Paul Pignon, interview with author, 2017; Paul Pignon, ‘Why I still Want to Make Music on the Synthi 100’, in *INSAM Journal of Contemporary Music, Art and Technology*, 3, 2 (December 2019), 15–18.

⁸ Luca Cossettini, ‘Radio as an Art Form in Former Yugoslavia: *Malo Večno Jezero* by Vladan Radovanović at Radio Belgrade Electronic Studio’, *Musica & Figura* 5 (2018), 179–198.

go to the Institute of Sonology in Utrecht and the Electronic Music Studio of Radio Hungary, in Budapest.⁹

This stasis followed by decline was not unusual in electronic music studios of this period that had invested heavily in new technologies in the 1970s: as I recounted in Chapter Five, the BBC Radiophonic Workshop faced similar problems, before making radical changes in the early 1980s and re-equipping the studios with new digital equipment. In turn, this affected smaller electronic musical instrument companies such as EMS and ARP, both of which struggled to survive into the 1980s. However, in Belgrade this situation was compounded by a severe recession in Yugoslavia in the 1980s, which affected many cultural institutions and activities,¹⁰ and political unrest leading to war in the early 1990s.

In 1999, Vladan Radovanović retired as the Studio's director. In 2002 the composer Vladimir Jovanović took over the position, after the Studio, which had been closed during the Kosovo War, reopened. By the early 2000s, as Milan Milojković writes, it was not an appealing location for composers: for some years it had had 'no investment whatsoever'; the equipment there was out of date and the Synthi 100 was not working.¹¹ Yet this unpromising environment proved inspiring for Jovanović, who used the Studio's minimal computer equipment to produce a number of compositions during his tenure there. Born in 1956, Jovanović was, like the minimalist composers mentioned in Chapter Six, one of a generation of Yugoslavian composers whose understanding of electronic music had been shaped by the Radio Belgrade Electronic Studio: as a student, he had taken the Studio's introductory course, and used the Studio to produce his first major electronic work, *Supermarket Sinfonija*, in 1988. In returning to where he had first worked with electronic music, Jovanović produced compositions that drew on some of the approaches of the Electronic Studio's past, demonstrating, Milojković suggests, the legacy of the Electronic Studio's founders, 'who viewed the electro-acoustic medium primarily in terms of enabling the realization of works featuring unique, peculiar sonorities and structures'.¹² It was as if the space of the Studio, reduced as it was, still held within it some of the concerns of

⁹ Biljana Srećković, 'Vladan Radovanović: Phonoverse – Electroacoustic Music, Sokoj, 2010' (review), translated from Serbian by G. Kapetanović, *New Sound* 38: 11, (2011), 109–112.

¹⁰ Writing for the British magazine *Contact*, Keith Potter noted that the Zagreb Biennale of 1987 had struggled to gain public funding for its programme that year, and the future of the festival was uncertain. 'Zagreb Music Biennale 1987', *Contact* 32, p. 60.

¹¹ Milan Milojković, 'Pilgrimage Through a Sound Horizon: A Guide Through the Electroacoustic Works by Vladimir Jovanović (1956–2016)', *New Sound* 49: 1 (2017), 79–96. (p. 84).

¹² Milojković, p. 86.

its originators. In this sense, the depleted technical resources of the studio mattered less than accumulated knowledge and philosophical considerations of electronic music and sound that had been developed and taught there. The Synthi 100, although it was no longer working, still exerted a fascination for composers, as the device around which the Studio had been constructed and on which important compositions had been made.

When Svetlana Maraš began her residency at the Electronic Studio as part of Radio Belgrade 3's initiative to relaunch the Studio and explore its heritage, it appears that she shared this fascination with the Synthi 100, although she herself – born in 1984 – had never used it or seen it working. But it was imperative for Maraš that the initial aim of the project should be to make the Synthi 100 operational again, as she regarded it as, 'the focus, the central part of the studio'.¹³ Maraš, a Serbian composer based in Belgrade, knew about the Synthi through networks of artists and musicians, and was cognisant of myths that had built up around it:

The story about the studio and the Synthi is well known to all the local artists [in Belgrade], and there have also been some legends, stories, related to the Synthi that were circling around for many years, getting many layers and shapes, such as the famous story that when the original group of composers went from the studio together with an engineer who was taking care of the Synthi, it was said that, being unsatisfied with the conditions they had at that time at the radio, they took one of the cards [circuit boards] from it so that it couldn't work any more! Of course, this turned out to be completely inaccurate, but there were stories like this circling around, so we were all familiar with different stories, true and untrue, related to the Synthi and the Electronic Studio.¹⁴

In an article for *Unearthing The Music* (an EU-funded project researching histories of experimental music in European countries that have been subjected to repressive political regimes), she explains, too, how stories had circulated about the instability of the Synthi 100's oscillators, which would drift out of tune when a window was opened. While this rumour was based on fact – early analogue synthesizers are indeed often sensitive to changes in temperature – it had become highly exaggerated. As a

¹³ Svetlana Maraš, interview with author, 2018.

¹⁴ Ibid.

result of these stories, some of the technical staff of the radio station did not think it was possible for the Synthi to be fixed. Maraš writes,

The Synthi caused a great deal of admiration and fear at the same time – once it stopped working, it was treated like a relic and although Radio technicians were perfectly capable and competent enough to fix it, nobody dared. That’s why I got so many suspicious looks during the first few months at the studio while I was calmly repeating it was now the time to fix the Synthi, that it would happen for sure, we would finally be able to work with it again – well, you should have seen those skeptical faces turning (after one year) into big smiles after they heard the Synthi working again.¹⁵

While aware of the legends surrounding the Synthi 100, here Maraš also participates in the creation of new ones, such as the story of the ‘relic’ brought back to life through her enthusiasm and confidence. These stories and legends play an important role in projects of restoration of technologies, helping to generate support for and wider interest in the work. In other words, the stories we tell about an instrument’s restoration are, too, part of the process of restoration.

In the following sections, I describe how the project initiated by Maraš and Radio Belgrade 3 took place through and across an international, intergenerational, interdisciplinary and cross-institutional network of individuals and organizations. Through this process, the project has encompassed not only the material restoration of the Synthi 100 but also the construction and reconstruction of a body of knowledge around the instrument and the Studio.

7.3 Networks of reoperationalisation

7.3.1 Restoring the Synthi 100 in Belgrade, Athens and Ghent

The restoration of the Synthi 100 in Belgrade was made possible through a network of connections and bodies of knowledge that I will describe briefly here. Svetlana Maraš, who was the recipient of Radio Belgrade’s Vitomir Bogić prize for best young radiophonic composer in 2013, has composed radiophonic works that have been

¹⁵ Svetlana Maraš, ‘How Radio Belgrade’s EMS Synthi 100 was repaired’, *Unearthing The Music* (2019) <https://unearthingthemusic.eu/posts/how-radio-belgrades-ems-synthi-100-was-repaired-svetlana-maras/>

broadcast both in Serbia and internationally; she therefore came to Radio Belgrade 3 with knowledge of the broadcasting company's structure, practices and history – as indicated above in her description of the legends that circulated around the Synthi 100 – and experience in how to work with such an organisation. When the Radio Belgrade 3 producers Ksenija Stevanović and Irena Neimarević contacted Paul Pignon to ask his advice on beginning the restoration, he suggested working with two engineers, Jari Suominen and Daniel Araya; by coincidence, Suominen and Maraš knew one another from the Media Lab at Aalto University, Helsinki, where both had studied. As Pignon says of the project's main actors, 'it's a somehow strangely close-knit circle'.¹⁶

Daniel Araya is the studio engineer at Stockholm's Elektronmusikstudion (known as EMS: as in previous chapters, I will refer to it as EMS Stockholm to avoid confusion with EMS in London), an institution with which Pignon has worked periodically since his move to Sweden in the 1980s. A proportion of Araya's work involves the maintenance and mending of synthesizers from the 1970s, such as EMS Stockholm's Buchla and Serge systems; he is also a builder of his own musical devices and a producer of electronic dance music.¹⁷ Jari Suominen, an artist and researcher based in Helsinki, is also experienced in working with historical electronic instruments, having been part of an extensive project to research and rebuild the instruments of Erkki Kurenniemi, the Finnish composer and inventor whose research into digital control of sound in the 1960s and 70s parallels some of the projects being developed at EMS at the same time. Interestingly, Kurenniemi had visited EMS in London in 1970, hoping to interest Zinovieff and his colleagues in his DIMI-A synthesizer, a small programmable synthesizer that he envisaged as a possible commercial product.¹⁸ The two companies, EMS and Kurenniemi's Digelius Electronics, aimed towards similar goals, both technological – in building synthesizers that incorporated digital control – and commercially.¹⁹ Suominen's extensive research

¹⁶ Paul Pignon, interview with author, 2017.

¹⁷ Frances Morgan, 'Experimental Laboratory', *The Wire* 365 (July 2014), pp. 32–39 (p. 38).

¹⁸ M. Ojanen, J. Suominen, T. Kallio, and K. Lassfolk 'Design Principles and User Interfaces of Erkki Kurenniemi's Electronic Musical Instruments of the 1960s and 1970s', *Proceedings of the 2007 Conference on New Interfaces for Musical Expression (NIME07)* (New York: NIME, 2007), 83–93 (p. 91); Suominen, correspondence with author, 2017.

¹⁹ Suominen notes that when Kurenniemi contacted music institutions trying to sell the DIMI-A, he found that many of them had just bought a VCS3, and soon Kurenniemi followed suit, purchasing a VCS3 himself. Suominen, 'Erkki Kurenniemi's Electronic Musical Instruments of the 1960s and 1970s', in *Erkki Kurenniemi: A Man from the Future*, ed. by M. Mellais (Helsinki: Finnish National Gallery, Central Art Archives: 2013), p. 146.

into Kurenniemi and his interest in early digital electronics therefore provided knowledge that was easily transferrable to the Synthi 100, whose sequencer used a similar transistor–transistor logic to that of the DIMI-A. Suominen’s DIMI Is Reborn project saw him take his research further in building a replica – what synthesizer builders usually call a ‘clone’ – of the DIMI-A, and as part of that project he undertook a residency at EMS Stockholm, connecting him with Araya and Pignon.²⁰

Suominen and Araya, born between the late 1970s and early 1980s, come from a generation of artists and engineers in which it is not unusual to combine research into historical electronic music with producing new digital artworks, making electronic dance music, playing in experimental rock bands and numerous other activities as well as instrument-building and repair work. While both are or have been affiliated with public arts and academic institutions such as EMS Stockholm and, in Suominen’s case, the Finnish National Gallery and others, they are also involved in subcultures of electronic music and media arts as well as what we might call subcultures of making, such as ‘hackspace’ culture and online networks around instrument building and cloning.

While I have separated out these different kinds of activities by listing them in this way, they are not necessarily experienced as so very different by the people involved in them. On an individual level, we are always, of course, aware of the material differences between our professional lives and what we do away from the workplace, and of the differences in scale – as well as the different requirements and restrictions in place – when a project is funded by an institution or company and when it is self-supported, but in terms of the actual activities being carried out, the distinctions of ‘professional’, ‘amateur’, ‘academic’, and so on, are less relevant than the naming of what is being done in more active, practical, terms – making, researching, fixing, performing, composing, and myriad other activities that can be gathered under a general heading of electronic ‘musicking’.²¹ Through these activities, various communities of practice form, overlap and communicate with one another around the central idea of electronic music technology. Such activities engage with electronic music’s past as an ‘arising, originating past, the active and effective past’, to borrow Ebeling’s description of archaeological methodologies used in the study of

²⁰ See <http://elektronmusikstudion.se/composers/2016/628-jari-suominen-ems-dimi-is-reborn>

²¹ cf. Christopher Small; see also Chapter One and Chapter Eight.

knowledge.²² As I noted in Chapter One with reference to the material cultures-focused approach to electronic music histories exemplified by researcher-makers such as Sean Williams, and Tom Richards, who has recently constructed Daphne Oram's previously unrealised Mini-Oramics machine,²³ practitioners such as these develop their skills not only through academic and professional training but also through DIY experimentation and, to varying degrees, via networks of independent commercial engineers who run small building and repair businesses or produce kits for making your own devices. A closer look into how such practitioners develop their skills would reveal further, intricate connections consisting of friendships and formal and informal working relationships with numerous enthusiasts and amateur musicians, composers, artists and makers, as well as academically unaffiliated archival researchers.

We can draw a comparison here with the 'marginal' figure²⁴ whom I identified in Chapter Six as particularly important to the development of the postwar electronic music studio: figures such as Paul Pignon, Peter Zinovieff, Tristram Cary and Brian Hodgson, whose ability to move between different social, cultural, institutional and scientific-technological registers contributed to the formation of an electronic music studio culture. In this culture, the presence of what Laura Zattra identifies as 'individuals with diverse but intertwined competencies' made it possible to form the connections with engineers, musicians and organisations necessary for establishing such structures as an electronic music studio or an instrument building company, and for working efficiently within those structures.²⁵ The marginal person of the present day similarly moves between various registers, establishing their membership of electronic music communities of practice through what Bowker and Star describe as 'the experience of encountering objects and increasingly being in a naturalized relationship with them',²⁶ which is then shared with and reinforced by other members of the community. Like their forbears, this marginal person also responds to and co-constitutes a culture of electronic music, which has now expanded its range of

²² Ebeling, p. 11.

²³ Tom Richards, *Oramics: Precedents, Technology and Influence: Daphne Oram (1925-2003)* (unpublished PhD thesis, Goldsmiths, University of London, 2018).

²⁴ As defined by Goffrey C. Bowker and Susan Leigh Star in *Sorting Things Out: Classification and Its Consequences*. (Cambridge, Mass; London: MIT Press, 1999), p. 303.

²⁵ Laura Zattra, 'Collaborating on composition: The role of the musical assistant at IRCAM, CCRMA and CSC', in *Live Electronic Music. Composition, Performance and Study*, by F. Sallis, V. Bertolani, J. Burle and L Zattra, eds. (Routledge ebook, 2017), loc201.8.

²⁶ Bowker and Star, p. 295.

locations to include not only studios and workshops but numerous online environments, as well as, to a greater extent than in the past, live music spaces, art institutions and museums. As I proposed in Chapter Six, in the 1970s the Synthi 100 became an object around which a community of practice formed at Radio Belgrade; in the present day, the same instrument takes on a similar role in new networks and communities that likewise draw knowledge and expertise from institutional, technological and artistic milieus. We might also say that an international community of practice has formed that is focused specifically on the restoration and re-presentation of various models of this one particular device.

For example, Pignon recommended Araya and Suominen to Radio Belgrade not only because he knew them through EMS Stockholm but also because, around the time that Radio Belgrade contacted him about their Synthi 100, Araya and Suominen had just completed another Synthi 100 restoration – this time in Athens, at the Contemporary Music Research Centre (known as CMRC-KSYME, and usually referred to as KSYME). In a similar manner to Belgrade, this restoration project was instigated by a prolific local musician, the composer and sound artist Marinos Koutsomichalis. The project was supported institutionally by both CMRC-KSYME and Documenta, the international contemporary art festival. Collaborating with EMS in Stockholm, Documenta14 commissioned new works for Synthi 100 by Swedish and Greek composers, including Koutsomichalis, to be performed at an event in April 2017 at which the histories of CMRC-KSYME and the Swedish arts organisation Fylkingen were compared and discussed; as well as this, the restored Synthi 100 and framed scores and schematics relating to its use were displayed at CMRC-KSYME.²⁷

The history of the Synthi 100 in Athens differs from that of the Belgrade Electronic Studio in some ways, both in its early life and in its recent reconstruction. In Athens, the Synthi 100 appears to have been used far less widely than in Belgrade. It was bought in 1975 by the Hellenic Contemporary Music Association, an organisation that hosted festivals and concerts and also ran an open studio at which the Synthi 100 was housed: in 1977, Simon Emmerson noted that, ‘for a very small fee, any composer may work with the Synthi 100 and associated equipment’.²⁸ Yet according to Koutsomichalis it was used only sporadically by local composers, who

²⁷ For a summary of Synthi 100-related events at Documenta14, including my own involvement, see <https://www.documenta14.de/en/artists/16209/ksyme-cmrc>

²⁸ Simon Emmerson, ‘Three Days of Contemporary Music, Athens, June 7–9, 1977’, *Contact* 17: 38 (1977), p. 40.

would mainly utilise it as a source of unusual sounds rather than a tool for making entire compositions. Eventually it was put in storage and left to fall into disrepair. Therefore rather than illuminating the history of Greek electronic music, its restoration – in Koutsomichalis’s view – brings to light the disconnect between generations of composers, and the gaps, as well as the achievements, in any narrative that could be constructed about electronic music communities in Athens. He states,

This instrument is around since the 70s in Greece, but you never encounter anyone from the old composers who actually had worked with it. They’ll say, “Oh yeah, I remember it was working, and I found a few tapes with recordings from it”, but they mostly used it as a sound generator ... If you think about it, for fifteen years or more, the instrument was installed in Greece in an era where many things were happening to Greece, cultural-wise anyway, and still I’m not aware of a single composition for Synthi 100, just composers using sounds every now and then. And then we fix it and we do this concert and you have two new works by Greek composers [Koutsomichalis and Panos Alexiadis], with an instrument that’s in the country for fifty years.²⁹

Koutsomichalis, similar in age to Araya, Suominen and Maraš, is, like them, interested in early electronic musical instruments from both a musical and technical perspective, which could more accurately be called a combined musical-technical perspective, as the two are tightly linked; as a composer and sound artist, like Svetlana Maraš, his interest lies primarily in how the distinctive qualities and functions of the Synthi 100 can be explored through current electronic music practice, rather than seeking to perform historically faithful versions of older compositions. Koutsomichalis’s view of the present day impact of the project provokes important media-theoretical questions about the operational lives of restored instruments, and notions of the value and status of ‘live’ performance, which I will address later in this chapter. It is also interesting to note that while the institutional connection with CMRC-KSYME is important to the restoration of the Athens Synthi 100, it is the support from an international arts organisation, Documenta, that has been the most significant for the project’s public profile.

²⁹ Marinos Koutsomichalis, interview with author, 2018.

The knowledge networks of other restoration projects have been more contained within their host institutions, such as the restoration of the Melbourne University Synthi 100 in 2015 by Leslie Craythorn, the chief technical officer of the university's music school, who, like Pignon in Belgrade, had worked with the instrument from when it first arrived in Melbourne in 1973. In 2016 Craythorn was given a prestigious Engineering Heritage Marker award for his restoration work and has worked with younger composers and current Melbourne University students wanting to make new music on the Synthi.³⁰

Through looking at these social networks of restoration we begin to see how the older engineer or studio technician emerges as a primary, highly active participant in these new, materially focused studies of electronic music instruments and studios, if not, like Craythorn, their actual instigator: far more so, in some cases, than composers.³¹ To give another example, the Synthi 100 at the Institute for Psychoacoustic and Electronic Music (IPEM) in Ghent is now working and being used in public-facing projects due mainly to the efforts of Ivan Scheppers, a technician who had worked there since 1979, when the Synthi 100 – the last to be built by EMS – was bought. At various points Scheppers had fought to prevent it from being sold by the University, either to a museum or a private collector; his wish was to see it working again and used by students and composers.³² For this to happen, there had to be support from a wider network of younger musicians, researchers and composers, as well as independent enthusiasts and engineers. From 2012, a slow process of fixing and restoring the Synthi 100 was underway, carried out by a Brussels-based engineer, Constantin Papageorgiadis, who, according to Scheppers, had done much of the work for free as there was no institutional funding for it. However, because of an interest in analogue synthesizers and electronic music history among younger electronic musicians, support for the Synthi restoration began to grow. Its cause was further taken up by local musicians, synthesizer enthusiasts for whom Papageorgiadis had

³⁰ Simon Leo Brown, 'Melbourne's 'Doctor Who' synthesiser EMS Synthi 100 Given Engineering Heritage Award', *ABC News Australia*, 8 September 2016. www.abc.net.au/news/2016-09-08/melbourne-doctor-who-synth-given-engineering-heritage-award/7820012

³¹ EMS's engineer, Robin Wood, has been a point of contact for many of these restoration projects, providing manuals, historical information and in some cases replacement parts, such as pins for the Synthi's pin matrices (Stephen and David Dewaele, interview with author, 2016; Tom Carpenter, interview with author, 2016; Robin Wood, interview with author, 2018).

³² Ivan Scheppers, interview with author, 2016.

done various repair jobs. These were the dance music producers David and Stephen Dewaele, known as Soulwax, who convinced Scheppers to let them borrow the Synthi 100 for a short time and use it in their studio.³³

In 2017, the now working Synthi 100 was displayed at De Krook, a new science and art centre at the University of Ghent, in the context of IPEM's research into music cognition and embodiment under its current director Marc Leman. It was used with new interfaces developed at IPEM, which controlled the playing of a new piece by Soulwax. Thus, the instrument became enfolded into the institution's current research concerns, as well as being used in a popular music context; it also demonstrated the University's investment in technological innovation as well as history and heritage.³⁴

As we can see from these examples, there are certain factors that contribute to restoration projects being perceived as successful, such as: the highly visible participation of well-regarded younger composers and artists; engineers with specialised experience in electronic musical instrument maintenance as well as an interest in electronic music histories; the sharing of tacit and written knowledge between generations, which requires the survival of documents – such as manuals and synthesizer patching diagrams – as well as embodied skills; the production of new work at prestigious events such as Documenta, or through a national broadcaster or academic institution; an historical connection with an electronic music studio; and some kind of institutional support for the new networks that have come together to realise this project. Such projects represent the kind of 'multivocal' ideal of interdisciplinary collaboration that Andrew Nelson extols in his book on Stanford University's CCRMA.³⁵ However – as when reading about the smooth, productive and profitable models of collaboration at CCRMA presented by Nelson – it is important to remember that one is likely to hear only positive accounts of these restoration projects from artists and organisers, who are speaking on the record to a researcher or journalist and are often doing so very soon after the execution of the work. This is not to say that the projects are not successful, or that they do not have positive outcomes,

³³ Ivan Scheppers, interview with author, 2016.

³⁴ P-J Maes, V. Lorenzoni, B. Moens, J. Six, and F Bressan, 'Embodied, Participatory Sense-Making in Digitally-Augmented Music Practices: Theoretical Principles and the Artistic case "SoundBikes"', *Critical Arts*, 32 : 3 (2018), 77–94 ; see also Frances Morgan, 'The EMS Synthi 100 : Dialogues Between Invention, Preservation and Restoration', *Fylkingen Tongues* (2017), https://fylkingen.se/tongues/index.php/may-tongues_/the-ems-synthi-100-dialogues-between-invention-preservation-and-restoration/

³⁵ Andrew Nelson, *The Sound of Innovation: Stanford and the Computer Music Revolution*. (Cambridge, MA: MIT Press, 2015) p. 8; see also Chapter One.

but that, for example, conducting interviews some years later, or indeed interviewing participants other than the most visible ones, would yield a wider range of opinions and reflections.

It is also important to recognise that equally valuable yet less publicly prestigious restoration projects happen outside of institutions. In some cases they inform or complement the more visible ones, as in the case of Constantin Papageorgiadis's involvement with the IPEM Synthi 100; in others they remind us of the many possible aims and priorities of restoration work, not all of which fulfill the criteria of the kinds of public-facing research projects that I have described in this section and will elaborate on in the following one. As Susan Leigh Star notes, keeping in mind the tensions and relationships between 'formal representations and unreported "backstage" work'³⁶ is not only imperative for reminding us who is not included in networks, who is anomalous or excluded or otherwise divergent from the 'successful' project, but also prompts us to think about how the 'backstage' work of constructing electronic music histories co-exists with its more visible manifestations in concerts, exhibitions and conferences.

7.3.2 Restoration, renovation, reconstruction: reoperationalisation

In his writing on the conservation of historical computers, Doron Swade outlines the various terms that, while often interchangeable in everyday speech, indicate differences in the extents, aims and outcomes of projects that re-make, in various ways, an historical technological device, a process that he describes more generally as one of 'experimental history'.³⁷ In doing so he provides a useful set of coordinates from which to think about what it means to restore a synthesizer like the Synthi 100. In Swade's assessment, a *restoration* – which is the word I have generally been using – returns an existing object to its original state, possibly but not always in working order. A *replication* or *replica* is the act of making a copy with an existing object for reference (Swade writes that a replica can be, for example, scaled up or down). A *reproduction* is also, in many senses, a copy. The difference here seems generally to

³⁶ Star, 'This is not a Boundary Object', p. 607.

³⁷ Doron Swade, 'Reconstruction as Experimental History: Historic Computing Machines', *Reconstructions: Recreating Science and Technology of the Past*, ed. by K. Staubermann (Edinburgh: National Museums Scotland, 2011).

be one of purpose and context: a reproduction, with its connotations of artworks and antique furniture, is primarily for display, whereas a replica's purpose is more functional. For example, a replica could give an insight into the working processes of an historical object to a researcher who cannot work with the original device because it is too fragile. A *reconstruction* can have a similar research objective, but in this case, unlike the replica, an object is recreated without an 'intact surviving example',³⁸ such as a musical instrument reconstructed from a few surviving elements. Finally, Swade lists simulation – the virtual or 'logical' replication of an object.³⁹ This is of particular relevance to researchers into electronic music histories: for example, as part of his research into Karlheinz Stockhausen's programming of the Synthi 100's sequencer on his composition *Sirius* (1977), Sean Williams has built a virtual version of the sequencer using Max/MSP in order to try and further understand Stockhausen's innovative use of the device;⁴⁰ and, as I describe later in this chapter, a digital project aimed at increasing musicians' access to the Synthi 100's sounds is being developed in Radio Belgrade's relaunched Electronic Studio. Meanwhile many analogue synthesizers are now produced in virtual versions as 'soft synths' – including the EMS VCS3, which has been produced as a soft synth and as an app for iPads and iPhones.⁴¹ While these latter simulations are intended for creative and commercial rather than research use, they are not dissimilar to the software simulations Swade describes – and could, of course, very easily be used in a research context.

None of Swade's definitions is intended to be proscriptive or fixed – many projects are likely to fall into more than one category, if not at the same time, at different stages of the work. Within those categories, too, are variations and nuances that depend on the priorities of a project – for example, a reconstructed device might look quite different if it is aiming for 'operational rather than visual realism'.⁴² However, the fluidity and interconnectedness of these categories is precisely what makes trying to think with them interesting, as in doing so we are prompted to consider a number of important questions, the overriding of which are to do with the aim and purpose of a project: what is it trying to demonstrate, and what answers are

³⁸ Ibid, p. 107.

³⁹ Ibid.

⁴⁰ Sean Williams, conversation with author, 2018.

⁴¹ The XILS3, a VCS3 emulator, was first launched by Xils-Lab in 2010 (<https://www.xils-lab.com>). The iVCS3 for iOS was developed by ApeSoft (<https://www.apesoft.it>) and commissioned by Jonny Trunk of Trunk Records, a UK-based record label and publisher that reissues archival film and television soundtracks and electronic music.

⁴² Swade, p. 108.

being sought? With these questions in mind we can think about the finer details of a restoration; for example, whether it is essential that all parts of a machine be original, or whether some can be newer equivalents – an example might be the type of wiring or the potentiometers in a synthesizer. Restorers may choose to create a new, updated version of a no longer working part in order to make it easier to use, or owing to the rarity, cost or unavailability of the original parts.

For example, Jari Suominen describes how, when working on the Athens Synthi 100, he replaced the no longer working sequencer with a replica, as there was not the funding to restore it exactly to its original state. He explains,

I studied all the documentation I had in my possession, and built a single board substitute based in AVR technology⁴³ to replace 13 missing PCBs. The interface parts of the new board are the same, so there is no difference in the workings of the sequencer to the original. And it includes MIDI.⁴⁴

As we know that the original sequencer had worked – and, had it been well maintained, as it was in the Belgrade Synthi 100, would have been updated and fixed over the years – it was less important for Suominen to rebuild it with original parts than it was for him to restore it to a state in which a musician’s experience of playing the instrument interface would be similar to what it would have been like at any point between 1973 and whenever the Synthi 100 stopped working; additionally, in adding MIDI, Suominen was making his own update to the instrument that would make it easier for a contemporary musician to use. However, had the aim of the project been to replicate the conditions of the Synthi 100’s original assembly, the sourcing of original parts, or replicas of parts that would have been available in 1969–71, would have been imperative.

Certain terms that Suominen uses to describe his work in our interview suggests another two categories that could be added to Swade’s list of types of restoration processes: ‘renovation’ and ‘maintenance’. Renovation can be regarded as a synonym for restoration, but its usage in everyday speech reveals some interesting details. In UK English it is used mainly to refer to buildings, rather than objects, and tends to

⁴³ AVR refers to a type of microcontroller that is often used in Arduino projects.

⁴⁴ Jari Suominen, interview with author, 2017.

imply that the new version is not exactly the same as the original: a renovated building is often an improved, extended or modernised version of the original, to varying degrees. Whether intentionally or not, Suominen's use of this word when asked about the Synthi 100 accommodates aspects such as the replica sequencer with added MIDI that he built for the Synthi 100 in Athens, as well as the pragmatic financial decision-making that he and Daniel Araya made while carrying out both projects. In an interview with Svetlana Maraš about the Belgrade Synthi, Araya states,

We service instruments that are going to be used and not just sit in a collection and we do it for institutions that have limited budgets. We try to stay true to the original nature of the instrument, but some of the parts used were terrible, really, and did not stand either the test of time or the test of musicians! So we try to keep a middle ground, we are not scouring the Internet for identical potentiometers, we get better quality ones instead and we change out bad types of switches for modern models even if they look slightly different from the originals. To do a museum-quality restoration would take enormous amounts of time and money and it would probably not hold up for day to day use.⁴⁵

Araya and Suominen's focus on maintenance and operational performance also challenges the idea that there is an ideal original state to which a Synthi 100 should, or even can be returned. It can be viewed instead as an instrument with an ongoing life-span that, while it has not been used for some time, has already undergone various repairs, modifications and alterations, and can therefore accommodate more. While this is a practical view, it is also a philosophically intriguing one, resonating with writings in media archaeology that prioritise operability through the idea that media is in itself uniquely and constantly operational (see Ebeling, who insists that 'media is always effective and operative';⁴⁶ and Wolfgang Ernst's notion that, although we might access the 'thinking and working time of the past' in an historic 'chronopoetic' device such as a synthesizer, it becomes 'ahistorically operative' when restored and used again in the present day⁴⁷). If we are to take the view that electronic musical

⁴⁵ Araya cited in Svetlana Maraš, 'How Radio Belgrade's EMS Synthi 100 was repaired'.

⁴⁶ Ebeling, p. 12.

⁴⁷ Ernst, *Chronopoetics*, p. 212.

instruments are media technologies, operating in Georgina Born's 'medium time',⁴⁸ Suominen and Araya's conceptualisation of them as devices to be maintained throughout a long operational life-span rather than 'dead' technologies to be revived is a useful materialisation of such theories.

As in Swade's description of the reconstruction of historic computing devices, we also find that instrument restoration projects have multiple purposes and outcomes, serving researchers, musicians, audiences and funders in different ways. For example, while the aim of the Belgrade and Athens Synthi projects was primarily to make the synthesizers work again and fit to be used by musicians, these projects also produced valuable research. Suominen gives this account of what restoration offers the researcher, based on his experiences:

From the research point of view, doing low-level hands-on work is fundamental for making observations about the design process and inner workings of the instrument. In huge instrument development projects like DIMI or Synthi 100, I'm often asking myself if the designers really knew what they were doing or if they were really working at the limits of their skills. From the component timestamps you can figure out dates for mods and fixes in the original instruments. All in all, there are many details that you will only notice by working on an instrument.⁴⁹

These observations that Suominen describes as a by-product of maintenance work are part of a process of *reoperationalisation* that includes not only the restoration work itself, but also the gathering and consideration of new information about a device through working on it, as described above; the composition of new works; performances such as the televised one I describe in section 7.4; the challenges to accepted narratives about the Synthi that I described earlier in the chapter; the cataloguing of archival material; and the formation of new narratives through writing and speaking about a project. While we can practically separate these different actions

⁴⁸ Georgina Born, 'Making Time: Temporality, History and the Cultural Object', in *New Literary History*, 46: 3 (2015), pp. 361–386. Here, Born considers various ways in which temporality is articulated in cultural objects, noting that these objects themselves produce time, 'in not one but several dimensions of temporality'. She defines one of these dimensions as 'medium time', a 'nonhuman' time that is produced by technologies of media.

⁴⁹ Jari Suominen, interview with author, 2017.

and events out into categories and stages of projects, conceptually we can consider them different facets of reoperationalising electronic music's past.

The restoration of the Belgrade Synthi 100 can be viewed as an overarching process of reoperationalisation that encompasses many different areas of scientific, technological and cultural work, from the engineering and craft skills of the restoration itself to engagement with the media, public presentation and educational projects, and, of course, the composition of new music that does not seek to imitate that of the past. This last factor is particularly important, as it sets projects such as this apart from other endeavours in musical instrument restoration, which aim often for authenticity and the ability to play certain repertoire in an 'historically informed' way.⁵⁰ It also reminds us of a fundamental difference between the restoration of an historic synthesizer and that of, say, a steam train, a radio or even an early computer, the aim of which is generally not to write completely new programmes on the restored machine, although of course this could be an exciting thing to do. In this case, the positioning of the Synthi 100 as part of Radio Belgrade's history and the history of electronic music in Yugoslavia works in tandem with a drive to present it as a maintained instrument, rather than an antique one, on which, after a period of inactivity, new music can be made in conjunction with new music technologies and across different generations of musicians. In other words, to use a term from DM Withers's study of feminist music archives in the digital era, it becomes a facilitator of 'transmission' between electronic music's past, present and future.⁵¹ The production of entirely new compositions, which are then recorded and broadcast on the restored instrument, as I describe below, emphasise the multidirectional aspect of transmission and the complexity of electronic music technology in the ecology of what Bernard Stiegler calls the 'memory industries'.⁵² To include electronic music, with its focus on recording, storing and reproducing sound, as part of, or intimately connected to, these industries reminds us of the value of considering the history of electronic music technology as a history of media. In the following section I bring some of these concerns together by describe the Synthi 100's reoperationalisation within a media network of television and radio.

⁵⁰ See Christopher Small, *Musicking*, pp. 90–91 and 116–7 for an examination and critique of the perceived authenticity of 'historically informed performance'.

⁵¹ D.M. Withers, *Feminism, Digital Culture and the Politics of Transmission* (Lanham, MD: Rowman Littlefield International, 2015).

⁵² Bernard Stiegler, *Technics and Time, 2: Disorientation*. 1998. Translated from French by S. Barker, 2009 (Stanford: Stanford University Press, 2009), p. 127.

7.4 Live from Studio 6

7.4.1 *Radio Concerto No 1* and mediatized visual cultures of live electronic music

In March 2018, a performance celebrating the re-opening of the electronic music studio at Radio Belgrade was filmed for the *Concerts in Studio 6* series, a live music programme in which concerts are watched by a studio audience and simultaneously broadcast on Radio Belgrade 3 and the digital TV channel RTS3. At this concert, new works by Svetlana Maraš, Paul Pignon and the Italian musician Nicola Ratti were performed in two spaces within the Radio Television Serbia (RTS) building: Studio 6, a space set up for live concerts with an audience, and the Electronic Studio – on a different floor of the building – where Maraš performed a piece called *Radio Concerto I*. Her performance was filmed and screened live for the audience in Studio 6. The objective of the concert was to celebrate the reopening of the Electronic Studio and thus also commemorate its history; however, while a short film from 1972, which uses one of Pignon's early tape pieces as its soundtrack, was shown as part of the programme,⁵³ the main focus was on new music, rather than the playing of recorded works from its early, and most active, period. Vladan Radovanović attended the concert as a guest and was briefly interviewed, but none of his music was featured; according to Maraš, while future programmes may focus more on his compositions, she and her colleagues wanted this one to be a presentation of 'live electronic music', rather than recorded works.⁵⁴

What performance theorist Philip Auslander has called 'liveness'⁵⁵ is a tricky concept that surfaces in studies of electronic music in various ways, from some of the philosophical writing on the ontological status of the performed musical work mentioned in Chapter One and considerations of acousmatic performance as 'live' to studies of how, for example, laptops and other digital devices are used in performance, often written from a practitioner's perspective.⁵⁶ As Angela Ida de Benedictis notes,

⁵³ The untitled film, directed by Srđan Barić, is soundtracked by Pignon's tape composition *Yeah* and shows Pignon in the Electronic Studio.

⁵⁴ Svetlana Maraš, interview with author, 2018.

⁵⁵ Philip Auslander, *Liveness: Performance In a Mediatized Culture*, 2nd edn. (Abingdon/New York: Routledge, 2008).

⁵⁶ See Sarah-Indriyati Hardjowirogo, 'Instrumentality. On the Construction of Instrumental Identity', in *Musical Instruments in the 21st Century: Identities, Configurations, Practices*,

ever since electronic compositions have been performed in concert, they have challenged traditional ideas of the relationship between composer, work and performance and raised the important question of whether ‘an authorial performance tradition’ such as that which underpins Western classical music can actually be established at all in this field.⁵⁷

Various instances of electronic music in concert have been described in this study, going back to Unit Delta Plus’s Concert Of Electronic Music in 1966, through Peter Zinovieff’s presentation of a computer at the Queen Elizabeth Hall in 1967 (see Chapter Two); the television portrayal of mixed electronic-acoustic music in the late 1960s (Chapter Three), the BBC Radiophonic Workshop’s displaying – but not actually playing – the Synthi 100 at the Royal Festival Hall as a demonstration of British electronic engineering; and the adoption of EMS VCS3s by live electronic music ensembles such as Intermodulation (see Chapter Four), to name some examples. How electronic music, which depends upon a range of different sound reproduction technologies for its performance, is understood as ‘live’ music is a concern that is present in all these historical examples; it is also an issue that has become increasingly complex as new interfaces develop along with the growth of music software designed specifically for use in live performance, some of which, as I describe below, were used in Maraš’s performance in *Concerts In Studio 6*. Concurrently, developments in multimedia and virtual presentations of music and other media challenge what it means to experience as well as make live music.⁵⁸ It is beyond the scope of this thesis to offer much more than a brief reflection on changing notions of liveness in electronic music; however, the performance I write about here demonstrates that there continues to be – however we define it – a desire for liveness among musicians, promoters/broadcasters and, presumably, audiences similar to that which we can locate in those 1960s and 70s presentations of electronic music described in previous

ed. by T. Bovermann, A. de Campo, H. Egermann, S-I Hardjowirogo and S Weinzierl (Basel: Springer Link ebook, 2017), 9–24, for a useful survey of current literature on this topic.

⁵⁷ Angela de Benedictis, ‘Authorship and performance tradition in the age of technology: (with examples from the performance history of works by Luigi Nono, Luciano Berio and Karlheinz Stockhausen)’ in *Live Electronic Music. Composition, Performance and Study*, by F. Sallis, V. Bertolani, J. Burle and L Zattra, eds. (Routledge ebook, 2017), loc501.0.

⁵⁸ See Nicholas Cook and Justin Gagen, among others, in *The Oxford Handbook of Music and Virtuality*, ed. by S. Whiteley and S. Rambarran (Oxford: Oxford University Press, 2016).

chapters. In this chapter's example, there is a specific desire for liveness to be present and legible in a performance that uses historical music technology.

In the case of the Studio 6 concert, liveness manifests in a number of ways. Pignon plays an amplified bass clarinet, triggering patches on the Synthi 100 via its frequency to voltage convertor; the Synthi then re-processes the clarinet's sounds, with which Pignon then interacts. Ratti plays a small modular synthesizer, incorporating some pre-recorded sounds from the Synthi 100 into his performance via a laptop. Both of these performances use techniques that are highly legible as 'live' (the processing of acoustic sound made by a wind instrument, and the playing of a small electronic instrument); although, in Ratti's case, some pre-recorded material is used, it is triggered by him and thus likely to be experienced as 'live sound' by the listener.

Maraš's performance, which takes place in the Electronic Studio itself (while Pignon and Ratti perform in the regular concert space of Studio 6), presents the Synthi 100 as a live instrument similar to Ratti's synthesizer and Pignon's clarinet, but it takes place under noticeably different conditions that do not adhere to concert performance conventions. To give one obvious example, the Electronic Studio is brightly lit from overhead lights, in contrast to the atmospheric stage lighting used for the other two performances; and, perhaps most importantly, Maraš is in a different room than her audience, who can see her only via a screen. Therefore, while it is readable as a dramatic, active and visually interesting live performance in ways that I will elaborate below, the setting also references the Synthi 100's history as a studio-based device, by situating the performance in the Electronic Studio itself, filming it and presenting it to the audience in the live studio in a way that is unarguably and deliberately 'mediatized', to use Auslander's term.

Auslander's useful conceptualization of 'liveness' as a word that 'is not used to define intrinsic, ontological properties of performance', but is instead 'a historically contingent term' informs my reading of the ways in which this televised performance can be understood as live, or containing liveness.⁵⁹ Increasingly, Auslander writes, 'mediatization, the technology of reproduction, is embedded within the language of live performance itself'.⁶⁰ Although he is referring here to performance art that uses audiovisual elements such as video, similar technologies of reproduction are also

⁵⁹ Auslander, p. 60.

⁶⁰ Ibid, p. 45.

found in many performances of electronic music, and are used in particular ways in performances using historical music technologies.

In Maraš's own words, her *Radio Concerto No 1*, in which she uses the Synthi 100 and a tablet running PureData and Ableton Live and the TouchOSC interface, creates 'improvisational dialogues' between the Synthi and the computer. It is possible to see and hear how Maraš explores the gestural possibilities of the synthesizer and the tablet, manipulating the synthesizer's joystick, dials, sliders, trapezoids, and their digital equivalents on the touchpad, creating 'a dynamic interactive interface on the tablet and tweaking the Synthi sounds live and playing with their parameters' (interview with author, 2018). As in early works created in the Radio Belgrade Electronic Studio, such as Paul Pignon's *Hardware Performance*, the emphasis is on timbre as a means of structuring the piece, as the composer quite systematically explores the different functions of the Synthi that display its timbral range. An aim of Maraš's *Radio Concerto* was to explore some of the similarities between her own, primarily digital working methods and that made possible by the Synthi 100, formulating a relationship between technologies and practices that she explains in this way:

I hadn't been working with modular synths a lot before this – I'm more into, I would say, computer music. But somehow the Synthi 100 is completely different from other modular synths and the essential difference is these two patch boards, it provides certain combinatorics that for me were quite similar to the tools that I work with when I make music on a computer, kind of like this PureData way of thinking. So was pretty intuitive for me to learn how to use [the Synthi 100], but what I felt was a challenge was to use it in a live performance as an instrument with a kind of certain range of possibilities that I can access at any time, and to use it kind of as a versatile instrument where I can change and move through different sounds and particularities of sound very fast.⁶¹

The portrayal of the Synthi 100 as a 'versatile instrument' is achieved in the film through the wide variety of sounds used in the piece and by Maraš's highly active, gestural movements around the instrument, which demonstrate to any viewer,

⁶¹ Svetlana Maraš, interview with author, 2018.

whatever their knowledge of synthesizers, that this is a device that can be manipulated to produce those sounds. The sense of the instrument's versatility is also conveyed through the way in which the performance is filmed. A handheld camera moves with Maraš, focusing closely on her hands as she manipulates the touchpad of the tablet and the controls of the Synthi, and then moving upwards to her face, which is seen in close-up and in profile. This is edited with shots from above and behind, in which the Synthi's size appears particularly striking, Maraš seeming small in comparison to it; these shots emphasise a kind of athleticism to the performance in which the performer has to move quickly between controls, stretch up to turn the dials on the highest rows on the control panels or lean down to turn the lower ones. Much of the musical material consists of busy, fast-moving rhythmic patterns, which are indexed to these fast camera movements.

The performance as a whole responds to those demands for televisual 'proximity and intimacy' that Auslander, drawing on Walter Benjamin, isolates as having influenced mediatized live performance from the mid- to late-twentieth century onwards,⁶² and also recalls Thomas Cohen's study of televised classical music performance in which he identifies the importance of the audience being able to see the instrumentalist's face in a performance.⁶³ However, I propose that, alongside filmed performance for broadcast television, there is now an online visual culture of electronic music making that, while influenced by televisual conventions, demands an even greater proximity and intimacy by mediatizing not only the performance but also the composition of music, often in a musician's private space rather than a concert venue. This culture, dependent as it is on easy access to making and streaming videos, post-dates Auslander's original 1999 study and to some extent its second 2008 edition, as well as Cohen's 2009 book; it is the culture of YouTube synthesizer demonstrations and the 'Against The Clock' videos produced by *Fact* magazine, in which musicians, usually filmed in their home studios, are given ten minutes to create a track.⁶⁴ The physical and virtual workspaces used by the musicians – that is, both their studios and

⁶² Auslander, p. 184. See Benjamin, 'The Work of Art in the Age of Mechanical Reproduction'. Translated from German by H. Zohn. In *Illuminations* (London: Fontana, 1973 [1935]).

⁶³ Thomas Cohen, *Playing to the Camera – Musicians and Musical Performance in Documentary Cinema* (New York: Wallflower Press/Columbia University Press, 2009), p. 81.

⁶⁴ See <https://www.factmag.com/tag/against-the-clock/> for examples of these videos.

the visual displays of their digital audio workstations, if that is what they using – are reconfigured by the process of mediatization into performance spaces, so that composition becomes inseparable from performance. However, this is not quite the same as filming an improvised performance, although in that situation we can also say that music is being composed and performed at the same time; the musicians in ‘Against The Clock’ are not necessarily improvising, or, more accurately, they do not necessarily see themselves as improvisers, although some may do. Rather, they are often constructing sounds and music – building up layers of rhythms in Ableton or samples from a record – and what emerges at the end is a finished, if rough, *repeatable* piece of music, which contains both spontaneous and programmed elements.

The filming of Maraš’s performance highlights the studio’s status as a workspace and her role as a composer-performer, so that, even though the piece itself only contains some elements of what could strictly be called improvisation, we feel that we are watching someone ‘make’ music in a step by step way. In contrast, the performances of Pignon and Ratti, while recognisably mediatized to some extent through the two musicians’ interactions with technology, uses of recorded material and so on, are still more easily recognisable as concert performances and are in keeping with certain conventions of filmed live music, whether electronic or not; this, despite the fact that both are composer-performers too, and Pignon’s performance appears to be highly improvisatory. For example, Pignon is filmed in close-up and medium close-up, his more recognizable acoustic instrument – the clarinet – the main object of visual focus; although the interest of his performance lies just as much in how the clarinet triggers complex operations on a synthesizer, the liveness of this performance is represented visually by a more conventional demonstration of instrumental skill.

In conclusion, the three performances of live electronic music in this episode of *Concerts in Studio 6* all contain, or present, slightly different ideas of mediatized liveness. Here, Paul Sanden’s development of Auslander’s theory of liveness from one mostly concerned with the makers of mediatized performance into a consideration of the increasingly complex ways in which audiences perceive musical performance to be ‘live’, is useful, as I explore how liveness is understood in new cultures of electronic music and also how it can be instrumentalised by institutions working with history and heritage.

7.4.2 Uses of liveness

Paul Sanden contends that, in its current form, musical performance can rarely be defined using the simple binary of ‘live’ and ‘recorded’, because there are so many instances that are ‘seemingly between these poles, in which liveness plays an important defining role’.⁶⁵

The value of Sanden’s continuation of Auslander’s project for my study lies not only in his specific focus on music (whereas Auslander primarily addresses theatre and performance art) but also in the way in which he asks why an audience might want to think of a performance as live, ‘despite [the term’s] apparent ontological inappropriateness’.⁶⁶ Liveness in this reading is a concept that helps to create music’s meaning, and it is understood in various ways and according to various, dynamic and interacting criteria including temporality, spatiality, fidelity to an original recording (as is often the case in pop music performance), spontaneity, corporeality and interactivity.⁶⁷ Sanden’s concept of liveness makes space for new mediatized spaces where live performance can be viewed and interacted with, such as YouTube and other online platforms. Sanden’s analyses remind us that liveness is a flexible and powerful concept among many musical communities and cultures; it follows, then, that the emerging culture around historical electronic music, or histories of electronic music, that my study engages with, has its own relationship with liveness.

Firstly, it is important to note that, in the specific case of the Radio Belgrade Electronic Studio, the focus on what we might call ‘visibly’ live electronic music on *Concerts in Studio 6* was not just due a consideration of what might be more appealing to watch – although this was clearly important – but a decision that alludes to an aspect of the Synthi 100’s historical use. Although, in his estimation, he was one of the few musicians (at Radio Belgrade) to work with the Synthi 100 in this way, Paul Pignon frequently used the Synthi 100 as a processor of acoustic instruments such as the clarinet and saxophone; additionally, his experiments with the Synthi 100 as a generative, ‘automotive’ device can be seen as congruent with an idea of live electronic music in which the electronic device is a responsive, possibly unpredictable

⁶⁵ Paul Sanden, *Liveness in Modern Music: Musicians, Technology, and the Perception of Performance* (London: Routledge 2013), p. 19.

⁶⁶ *Ibid.*, p. 20.

⁶⁷ *Ibid.*, p. 28.

co-performer. The fact that, practically speaking, it was generally not possible to conduct these experiments in front of audiences in a concert hall in the 1970s does not stop them from containing elements of liveness; we might say, then, that electronic music that demonstrably explores the interaction of human and machine – itself a long established convention within electronic music – has always had a presence in the Radio Belgrade Electronic Studio, and therefore this televised concert redresses an historical imbalance by making this strand of the Studio's work visible, while also bringing it into dialogue with new ways of performing live electronic music.

The technologies that make these new performances possible – programmes such as Ableton Live, Max MSP and PureData, as well as interfaces like Touch OSC, and the laptops and tablets that run these programmes – also make it possible to augment older technologies with new ones so that a composer-performer can produce a performance that, however we might ontologically consider its use of recorded or sampled sound, *looks* live, in which the performer is clearly triggering, processing, *playing* their device, whether that is a synthesizer or an iPad or laptop. This responds to one of the challenges that makers of television programmes have historically faced when presenting electronic music to audiences: we might recall, for example, the TV programme about electronic music mentioned in Chapter Three, *The Same Trade as Mozart*, in which Peter Zinovieff and Justin Connolly's *M-Piriform* is performed by a singer and two instrumentalists. An unattended tape recorder playing the electronic elements of the piece is placed in the performance space and the filmmaker chooses to anthropomorphize it, filming it as if it is a human performer. In other televised performances of mixed electronic music, such as Robert Cahen's *Boulez-Répons* or indeed Vladan Radovanović's *Variations For TV*,⁶⁸ the technics of television itself are used to respond to and the sounds of electronic music, with video processing and effects corresponding to their musical analogues.

While audiovisual presentations of this kind are certainly still popular in some contexts, dynamic human/technological interaction is now more easily shown in filmed performance, making a live performance of electronic music more achievable for the player as well as more exciting for the viewer to watch. However, it would be reductive to ascribe the appeal of liveness in electronic performance only to the technologies that make live performance possible. A prevalent interest in the material

⁶⁸ *Boulez-Répons* (dir. Robert Cahen, 1985); *Variations For TV* (dir. Vladan Radovanović, 1984).

qualities of sound in composition and sound-based art, which Joanna Demers relates to visual art discourses of materialism,⁶⁹ has meant that an instrument or device, rather than merely being the means to realise a musical idea, itself forms the aesthetic basis of a work. In practice this means that the material make-up, including the problems and limitations, of an unusual historical instrument such as a Synthi 100 can become opportunities for creativity. This approach is articulated clearly by Marinos Koutsomichalis, whose composition for Synthi 100, *Metaichmiako*, was also created to be performed live, without any other supporting technology such as laptops. Koutsomichalis explains, ‘What I do is about exploring materials, exploring processes. So I don’t seek perfection of any kind, actually I seek the imperfections of the instrument’, going on to elaborate on how he exploited the instability of the Synthi 100’s mistake-prone sequencer in his composition.⁷⁰

Koutsomichalis’s performance on the Synthi 100 at Documenta14 fits into a culture of electronic music that can be traced from Cagean ideas of aleatoric processes and chance operations and Pierre Schaeffer’s notion of the sound object, through genres such as noise, microsound and ‘glitch’, which amplify and use the malfunctions or unwanted sonic artefacts of musical and other electronic devices,⁷¹ and also shows the influence of sound art practice. Within this culture, a live performance using an historical electronic instrument is of interest precisely *because* the instrument has sonic and material properties that are unusual and unpredictable.

As I noted in the previous section, the filmed live performance of avant-garde electronic music for ‘official’ broadcast cannot be separated from trends in other online cultures of electronic music. Audience expectations in electronic music subcultures, particularly around modular synthesizers, have shaped what live electronic music looks like, quite literally, encouraging us to look closely at the technology while listening to music, which feeds an enthusiasm for watching unusual, rare instruments being played. Although a large part of this culture is semi-commercial, centred around newly built instruments that viewers can then buy, historical electronic instruments and the music associated with them are, as I described in Chapter One and reiterate in this chapter, of great interest to various networks of

⁶⁹ Joanna Demers, *Listening Through the Noise: The Aesthetics of Experimental Electronic Music* (Oxford: Oxford University Press, 2010), p. 84 and elsewhere.

⁷⁰ Marinos Koutsomichalis, interview with author, 2018.

⁷¹ Demers, p. 72–78; see also Marie Thompson, *Beyond Unwanted Sound* (London: Bloomsbury, 2016), p. 63.

electronic musicians, scholars, engineers and enthusiasts; and platforms such as Youtube, Instagram Stories, and so on provide a way of seeing and hearing rare instruments that many will never encounter in any other way.

To align Maraš's performance with these videos is not to reduce it to the status of a synthesizer demonstration, but to observe that the way in which her performance is filmed and transmitted acknowledges the appeal and effectiveness of these new, mediatized online electronic music performances whose aim is to demonstrate the capabilities of music technology as well as the performer's musicianship. This allows such a performance, also, to reach out to new audiences and practitioners who take part in new digital cultures of electronic music; and this appears to be an imperative of the new Electronic Studio.⁷² Here, we can detect an institutional rationale for the emphasis on liveness in the new Studio's first public event. As Maraš describes, since the opening in 2018, the Studio has hosted residencies for international and local artists, workshops with Paul Pignon and other practitioners, and begun work on a new project with the working title of 'Synthi on the Web', the idea of which is to create an online database of Synthi sounds and a kind of virtual patching interface so that people can experiment with it online even if they cannot access the instrument itself.⁷³ Additionally, Radio Belgrade 3 is one of the five organisations participating in Unearthing The Music, mentioned earlier in this chapter. The organisations participating in this project are engaged in collecting testimonies, oral histories, sound recordings, videos and other media to compile an online archive and database. Currently in its very early stages, it remains to be seen how Radio Belgrade 3 will go on to contribute to this record of experimental music practice in Serbia, but one of its first contributions was an essay by Maraš about the Synthi 100 restoration project, in which the composer expresses her aim to 're-activate the Electronic Studio as a space for gathering fresh ideas'.⁷⁴ Presenting a restored synthesizer as usable and accessible, and as a resource for live performance, achieves this aim in a highly visible way. It also responds to the remit of the European Broadcasting Union's Innovation Fund, which has been one of the restoration project's funders.

We might think here about how liveness can be instrumentalised in historical and heritage projects to do with electronic music, by looking at similar projects concerning

⁷³ Svetlana Maraš, interview with author, 2018.

⁷⁴ Maraš, 'How Radio Belgrade's EMS Synthi 100 Was Repaired'.

other technologies. Penelope Harvey points out that projects of scientific restoration are often presented by museums of science and technology in a way that creates dynamic narratives. To do this requires, ‘a disruption of rationalising abstraction, and a communicative process that restores some sense of visceral engagement’, she writes of a project at the Museum of Science and Industry in Manchester (MSIM) to reconstruct the ‘Baby’ computer, built at Manchester University in 1948. In other words, visitors need to be drawn into relationships with objects in order to be ‘enchant[ed]’ by them.⁷⁵ In this instance, the idea of local and national heritage also came into play, as Harvey notes that the chief restorer, Chris Burton, of the Computer Conservation Society, expressed a desire for the project to show that computing, which is often perceived as having developed in the US, has a rich history in the UK, too; and in Manchester in particular.⁷⁶

It is not hard to draw parallels with Harvey’s account of Baby’s reconstruction and the presentation of the Synthi 100 by Radio Belgrade 3 as part of the ongoing rehabilitation by Unearthing The Music of Eastern European avant-garde cultures; we can also connect the engaging, dynamic and celebratory narratives created by MSIM about their computer reconstruction with those created by Maraš around the restoration of the Synthi 100. To return to my earlier formulation of reoperationalisation as an umbrella term for all of these different aspects of restoration projects, the use of live musical performance and more generally of liveness as a powerful concept, show further ways in which electronic music’s past can be reoperationalised. In the case of the televised Studio 6 concert, the use of techniques of mediatization enables performances to reach and impact upon a large audience made up of members of various cultures of electronic music, while retaining the dynamic, desirable qualities of liveness. In conclusion, while the Synthi 100 is now recognized as a heritage object of importance and is protected by Belgrade’s Museum of Science and Technology, it is important for those who have initiated its restoration for it also to be seen as an operational, functional and accessible device that can be used within a modern composition, performance or sound art practice, and that is also

⁷⁵ Penelope Harvey, ‘Memorialising the Future – the Museum of Science and Industry in Manchester’, in *Science, Magic and Religion: the Ritual Process of Museum Magic*, ed. by Mary Bouquet and N. Porto (Oxford: Berghahn Books, 2005), 29-50 (p. 31).

⁷⁶ *Ibid.* 40.

symbolic of a continuum of experimental musical-technological practice and ‘sound and creative experimentation’ in Serbia.⁷⁷

7.5 Conclusion

Through the restoration of the Synthi 100 at Radio Belgrade, a studio composition tool which was for many years seen as obsolete has been re-presented as a live performance instrument, while the studio it was built for has been reopened and played host to new compositions and projects. In this chapter I have outlined the key events and personnel who were involved in this project, noting some key aspects of the restoration process and describing the restored Synthi 100’s appearance on the television programme *Concerts in Studio 6*.

This chapter continues the story that I began in the previous one, by showing, through this case study, another part of the Radio Belgrade Synthi 100’s trajectory from new invention to obsolete, non-functioning device to its current status as both a heritage object and a versatile, working instrument. However, the aim of this chapter has also been to explore various historical and theoretical considerations thrown up by restoration projects such as this one, which illustrates a number of ideas about how electronic music histories can be constructed and disseminated through practices of making, building and restoring; and through complementary practices of composition, performance and mediatization. Returning to Star’s formulation of the boundary object, and regarding the Synthi 100 as such, we might detect some of the ways in which ‘new alliances and cooperative work emerge[s]’ as a boundary object moves through time.⁷⁸

The project to restore the Synthi 100 and relaunch the Electronic Studio at Radio Belgrade can tell us about how historical electronic instruments figure in current practices and dialogues of electronic music, and how current discourses of electronic music affect how historical electronic musical instruments are treated and viewed now, confirming that, as John Tresch and Emily Dolan note, ‘tracing the different projects within which an instrument is deployed over time may illuminate large-scale structural transformations in the aims of musical composition and performance.’⁷⁹ To

⁷⁷ unearthingthemusic.eu

⁷⁸ Star, ‘This is not a Boundary Object’, p. 615.

⁷⁹ John Tresch and Emily Dolan, ‘Toward a New Organology: Instruments of Music and Science’, *Osiris*, 28 (2013), 278–298 (p. 295).

this I would add that we can also trace transformations in the aims and experiences of audiences and cultures of electronic music.

In this chapter I have situated the restoration project at Radio Belgrade within what I have called a network of reoperationalisation. This network consists in the first instance of the various actors involved in instigating, carrying out and publicizing the project, but also expands to include a larger, international network of practitioners and researchers engaged in similar projects. Again, the Synthi 100 provides a focal point for this network, which consists, in my reading, of institutions in Belgrade, Athens, Melbourne and Ghent, but also includes private restorers, enthusiasts, pop musicians and others, including myself as researcher and writer, as a contributor to the ongoing historical narrative of EMS and its instruments.









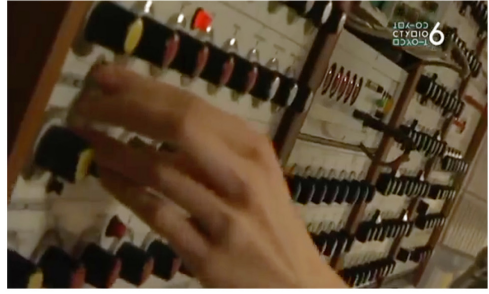

Chapter 8

Conclusion: Possible futures

8.1 Constructing histories of electronic musicking

The story of EMS, while highly specific to the small, London-based studio and company, also has much to tell us about the ways in which technology informed music-making, and vice versa, in the 1960s and 1970s. In recounting just a small part of this story, I have taken an approach that explores the interactions between people, institutions, spaces, texts and technologies, with an underlying concern about how electronic music practices and bodies of knowledge have been constituted, established and performed in different environments and through different objects through time.

Rather than following a strict chronological route through EMS's history from inception to closure, I have created something of an 'unauthorised biography', following themes generated by EMS's activities and inventions into other locations and concluding in the present day with a study of how the material conditions, design philosophies, performance practices and sonic signatures of electronic music's past can be accessed by what I have called a process of 'reoperationalisation' of an electronic musical instrument, in this case the EMS Synthi 100. Reoperationalisation involves not only the physical restoration of a device but also encompasses its capacity to create new compositions and performances; the generating of new historical narratives around it; and the formation of new musical-technical communities who research, rebuild, play, promote and otherwise activate the instrument. In examining this process, I ask how an object itself can be said to participate in constructing electronic music histories and an idea of electronic music's past.

I conclude not only that projects of reconstruction and restoration helps us access important facts about an instrument's design, manufacture, maintenance and so on, as we might expect; but also that these processes can be thought of as musical in themselves, through the activation of the sounds, concepts and temporalities contained within musical-technical objects, and the conceptualisation of these objects as having 'durable, external memories that makes human culture possible', as Jonathan de Souza

writes in his study of the relationship between the musical instrument and the performing body.¹ Throughout this study I have proposed a bringing together of ‘making’ and ‘making music’. This is an assertion that takes on a particular resonance in the case of histories of electronic music, in which instrument designers, composers and musicians have often had to work together to counter concerns that electronic musical instruments and devices such as computers are, if not antithetical to traditional ideas of musicality, at least an awkward fit with them.

In making this claim, I draw on Christopher Small’s notion of ‘musicking’, which refers to a conception of music as ‘an activity, something people do’.² Small coined this term as a counter to the ‘works tradition’ – the abstraction and reification of the great musical work in academic studies of Western art music which meant that, prior to the ‘new musicology’ formulated by Susan McClary, Lawrence Kramer and others in the 1980s and 1990s, ethnographic methods and social and political approaches to studying music were generally applied only to folk and popular musics; that is to say, music that is made by or understood as being dependent upon or constituent of social groups of people. In *Musicking*, however, Small examines the infrastructure of a concert performance of a classical symphony, from the design of the building to the hierarchy of staff working there, inviting the reader to understand the concert hall and, by extension, the symphony as a social construction that exists ‘wherever the Western scientific-industrial culture has gone and wherever a middle-class has grown prosperous from its activities’.³ Here, ‘musicking’ refers to the activities and gestures of the audience, the orchestral players, the conductor and the composer and the relationships between them all.

In my accounts of EMS’s formation within different milieus of new music, media art and science and technology in London in the 1960s, and in my account of media and institutional perceptions of computer music in the late 1960s and early 1970s, I examine the relationships not only between the main actors in this historical narrative and the technologies they use but also those between and within the institutional and professional structures in which they were situated. In my accounts of the different studio cultures of the BBC Radiophonic Workshop and the Electronic Studio at Radio

¹ Jonathan de Souza, *Music at Hand: Instruments, Bodies and Cognition* (Oxford: Oxford University Press, 2017), p. 26.

² Christopher Small, *Musicking: The Meanings of Performing and Listening* (Hanover, NH: Wesleyan University Press, 1998), p. 3; see also Chapter One.

³ *Ibid.*, p. 18.

Belgrade, I have taken a similar approach, regarding the construction, development and acquisition of new studio technologies as important activities alongside those of composing and performing.

Electronic musicking has historically required multiple diverse skills and a willingness and ability to work across creative and professional boundaries. As I reiterate throughout this study, EMS, and many other electronic music enterprises of the 1960s and 1970s, would not have developed without the actions of multi-skilled people such as Peter Zinovieff, Tristram Cary, Alan Sutcliffe and others, whose enthusiasm for new practices and readiness to participate in numerous aspects of electronic music's creation enabled the founding and running of electronic music studios. Within EMS and other studios, new creative and professional roles – such as the 'realisateur' of electronic music, the designer of musical-technological devices and so on – could be established. However, while electronic music studios made music-making accessible to people with different skills, and made possible otherwise inconceivable methods of composition and production, at the same time the spatial, technological, financial and institutional restrictions and, often, sheer impracticability of making music in an electronic studio of the 1960s and 70s created a tension that this thesis exposes and must be considered in any assessment of EMS's success or failure as a venture. This dialectic of conceptual openness and practically imposed exclusivity was played out in many electronic music studios and is, I would argue, an important part of understanding studio cultures of the 1960s and 70s.

8.2 Back to the studio

As I stated in my introduction, I began this project by placing EMS in the context of other studies of electronic music studios; yet it has also been clear from the outset that a more 'dispersed' model, looking at a wider context of studio cultures, would be productive, providing an opportunity to examine EMS's bid for a national electronic music studio in an international context and to highlight the company's role in establishing studios elsewhere, as well as acknowledging the non-institutional, commercial and multi-locational nature of EMS, with its factory, shop, overseas distribution networks and the changing addresses of the studio itself.

This is not to say that an in-depth historical-musicological study of the personnel, inventions, compositions, business model and studio culture of EMS, along the lines

of Niebur, Born and others,⁴ would not be productive. It is expected that James Gardner's forthcoming extensive study of EMS will fulfil this aim, giving an account of the studio and company's trajectory from foundation to closure and incorporating extensive oral history accounts. However, my study suggests a different approach, attempting to link together the EMS studio, the products made by the company and studios and institutions elsewhere, and explore, more generally, the idea of the electronic music studio, what it means and the attraction it exerts upon researchers. Within this framework I have also addressed the idea of the synthesizer as studio in itself, a proposition that would develop into digital audio workstations and the rise of the home studio, which correlated with a decline, from the 1980s to the 2000s, of public/institutional studios. My suggestion in Chapter Seven, however, is that younger musicians, composers and restorers such as those involved in the Radio Belgrade Electronic Music Studio restoration project demonstrate a fascination with studio cultures of the past and the advantages they perceive in them – while also being members of, and benefiting from present-day studio cultures, which are highly communicative, digitally networked, often geographically mobile and potentially more accessible to musicians from different genres and milieus, skills and backgrounds. Thus, I show how ideas of what the electronic music studio has been and what it could be, as well as material factors, inform how studios are historicised, remembered and, in some cases, rehabilitated; as well as how they disappear or fail to come to fruition.

I have described a number of studio cultures in this study, but focused in-depth on the BBC Radiophonic Workshop and the Radio Belgrade Electronic Studio, with this latter studio also providing an example of a restoration project. It is important to note that these are just two of a number of studios that housed EMS Synthesizers, and equally valuable studies could be undertaken on most of the others. For example, as I note in Chapter Seven, IPEM in Ghent provides rich material for a case study, as does the Studio for Electronic Music at Westdeutscher Rundfunk (WDR) used by Stockhausen, and the studio at Melbourne University where Tristram Cary worked after moving to Australia in the early 1970s, and which has recently been a focus of

⁴ Louis Niebur, *Special Sound: The Creation and Legacy of the BBC Radiophonic Workshop*. (Oxford: Oxford University Press, 2010); Georgina Born, *Rationalizing Culture: IRCAM, Boulez, and the Institutionalization of the Musical Avant-garde*. (Berkeley: University of California Press, 1995).

attention due to a high-profile Synthi 100 restoration project.⁵ There are also less well known, but equally interesting examples such as the short-lived electronic music studio at Indiana University South Bend, where Barton and Priscilla McLean created some of the few North American Synthi 100 compositions in the mid-1970s, as well as giving an extremely rare live, public performance on the instrument.⁶

8.3 The Synthi 100 and new, curious organologies of electronic music

Throughout this study, my interest in the ‘synthesizer as studio’ has led me to combine organological approaches from John Tresch and Emily Dolan, Paul Théberge and others with the historical studies of studios mentioned previously.⁷ As in Zabet Patterson’s study of the S-C 4020 plotter and its use at Bell Labs for computer art, focusing on a single device has provided a useful starting point for accounts of institutions and practices, as well as individual artists.⁸ However, in bringing together the device and its locations in this way, I have also attempted to illustrate one of the key concepts of the synthesizer: that it constitutes a working environment in itself, as well as being situated within one.

Unlike the S-C 4020 plotter, which was developed for scientific and industrial use and was reappropriated by artists, the Synthi 100 is a highly specialist, distinctly *un*-adaptable device that depended on a particular set of circumstances for its invention and production. As I state in Chapter Five, the Synthi 100 is notable for its immobility. Once it is set up, it rarely moves; its monumentality therefore demonstrates the dialectic I highlighted earlier in this chapter, that of the fixedness and inflexibility of

⁵ Simon Leo Brown, ‘Melbourne's 'Doctor Who' Synthesiser EMS Synthi 100 Given Engineering Heritage Award’, in *ABC News Australia*, 8 September 2016. www.abc.net.au/news/2016-09-08/melbourne-doctor-who-synth-given-engineering-heritage-award/7820012

⁶ Priscilla McLean, *Hanging off the edge: Revelations of a Modern Troubadour* (Lincoln, NE: iUniverse, 2006). Barton McLean, interview with author, 2018.

⁷ John Tresch and Emily Dolan, ‘Toward a New Organology: Instruments of Music and Science’, *Osiris*, 28 (2013), pp. 278–298; Paul Théberge, *Any Sound You Can Imagine: Making Music, Consuming Technology* (Hanover: Wesleyan University Press, 1997); Paul Théberge, ‘Musical Instruments as Assemblage’, in *Musical Instruments in the 21st Century: Identities, Configurations, Practices*, ed. by T. Bovermann, A. de Campo, H. Egermann, S-I Hardjowirogo and S Weinzierl (Basel: Springer Link ebook, 2017), pp. 59–66.

⁸ Zabet Patterson, *Peripheral Vision: Bell Labs, the S-C 4020, and the Origins of Computer Art* (Cambridge, Mass: MIT Press, 2015).

studios. Yet, at the same time, it was, and is, an instrument that promised infinite combinations of sound and structure, with which composers formed meaningful relationships based exactly upon this impression of infinite possibilities.⁹ The varied fortunes of the Synthi 100 models that were constructed from 1971 to 1979 tell us much about how local use affects instrumental identities, as well as how ideas about what constitutes an electronic music studio change over time.

The Synthi 100's dramatic trajectory from major institutional investment to obsolescence followed by rehabilitation in the present day cannot help but draw the researcher towards this instrument if they are interested in how objects are constituted socially and how their values and meaning shift over time, and how an object can take on the 'boundary' characteristics described by James Griesemer and Susan Leigh Star, which I introduced in Chapters Five and Six as a framework for thinking about how different communities of interest use and understand similar objects in different ways.¹⁰ Given its relative obscurity and the far greater cultural impact made of other EMS synthesizers the VCS3 and Synthi A and AKS models, the excitement and interest with which the restored Synthi 100s I describe in Chapter Seven have been met by institutions, musicians, journalists and enthusiasts is itself of interest to those seeking to map the shifting economic, social and cultural values of historic music technologies. There is also room here for a more critical perspective on these shifting values than this study has incorporated, such as an investigation into how the inflation in value of rare, 'vintage' synthesizers has correlated with a growing market for new, increasingly specialised, and often very expensive electronic musical instruments – while, at the same time, the music technology company Behringer has started to produce a number of low-cost 'clones' (i.e. unofficial recreations) of older synthesizers.¹¹

A critical study of the role of electronic music histories in producing the music hardware markets – and consumers – of the present day would be an important

⁹ Paul Pignon 'Why I still want to make music on the Synthi 100', *INSAM Journal of Contemporary Music, Art and Technology*, 3, II (2019), pp. 15–18; Priscilla McLean, *Hanging off the edge: Revelations of a Modern Troubadour* (Lincoln, NE: iUniverse, 2006).

¹⁰ Susan Leigh Star and James R. Griesemer, 'Institutional Ecology, "Translations", and Boundary Objects: Amateurs and Professionals in Berkeley's Museum of Vertebrate Zoology, 1907–1939', *Social Studies of Science*, 19 (1989), pp. 387–420.

¹¹ Behringer has in 2019 produced clones of the Sequential Circuits Pro-One, ARP Odyssey, Korg MS-20 and Roland TR-808.

addition to current synthesizer historiographies and ‘new organology’-based studies of electronic musical instruments.¹²

Researchers, too, must take some responsibility for our role in creating or influencing these value systems around historic instruments. Our own excitement about rare objects should not be made invisible or unimportant in our work; and our privileged encounters with those objects are significant. While my research was still at its early stages, I was given access to two Synthi 100s, one of which was in the process of being reconstructed by instrument builder Tom Carpenter, of Analogue Solutions. As he explained to me the long process of rebuilding the Synthi 100, my ideas about exploring the identity of the reconstructed, remade instrument began to take shape. I had already thought and written about how one might consider the work of electronic music and the material of its construction and the means of its execution not as separate entities but as inextricably connected and in constant dialogue with one another. But the presence of the half-built synthesizer in Carpenter’s workshop, with its brand-new, powdered metal control panels and a web of wires still to be connected behind them, consolidated these ideas around a physical object that, while ostensibly ‘not working’, was alive with operational potential. Every unusual connection revealed something about the time and conditions of its construction; other decisions – a pin matrix board that had been cut to the wrong size, an unexpected modification – remained mysterious. The theories of media archaeology that I had found interesting but overly speculative and abstract began to seem more useful, as if it might be possible to write about the synthesizer in a way that conveyed ‘the expressions of the machines themselves [and] functions of their very mediatic logic’.¹³

However, this aim had to co-exist with an understanding of my own limitations of knowledge – and, of course, the limitations of writing itself, as opposed to the practice-based research carried out by the many of the composers and engineers mentioned in this study. A month after visiting Tom Carpenter’s workshop, I went to IPEM at the University of Ghent, where I knew that a Synthi 100 had recently been restored and was now working again. At the time of my visit it was currently not at

¹² See Tresch and Dolan; also Maria Sonevytsky, ‘The accordion and ethnic whiteness: toward a new critical organology’, *The World of Music*, 50, 3 (2008), pp. 101-118; Tim Boon and Frode Weium (eds.), *Material Culture and Electronic Sound* (Washington: Smithsonian Institution Scholarly Press, 2013).

¹³ Wolfgang Ernst, ‘Media archaeography: method and machine versus history and narrative of media’. In *Media Archaeology: Approaches, Applications, and Implications* by J. Parikka and E. Huhtamo, (eds.) (Berkeley: University of California Press, 2011), p. 242.

IPEM, but being borrowed by the dance music producers Soulwax, who have a studio nearby. After a long interview with Ivan Scheppers, IPEM's technician and instigator of the Synthi's restoration, I left the University and walked to Soulwax's studio, expecting to have a look at the instrument and talk about it, maybe to hear one of the musicians play it. In fact, after a short chat, David Dawaele left me alone with the Synthi 100, which had been set up in the corner of a studio crowded with other equipment. I methodically dismantled the patch left on it by the previous musician and began, not quite so methodically, trying to build a new one. The synthesizer was connected to speakers, so everything I did was audible to anyone who came into the room, but I soon became unselfconscious about the noises I was making, and quickly forgot that I was playing a rare, painstakingly restored instrument of which there are very few working models in the world. Despite its size and complexity, the Synthi invited touch and interaction. After a few hours had passed, I realised I hadn't looked at the manual at all. This was not because I knew what I was doing; in fact, quite the opposite.

In her memoir, *Hanging Off The Edge: Reflections of a Modern Troubadour*, the composer Priscilla McLean describes how she first encountered the Synthi 100 at the studio she and her husband Barton McLean set up at Indiana University South Bend:

I stared unbelievably – here was a huge synthesizer, along a whole wall, with hundreds of “push-pins” ... and twenty-two oscillators. Bart handed me a long sheet he had written, an abbreviated “manual” to get me started, and I was supposed to begin with the first instructions and methodically proceed down the list, learning the techniques of sound-alteration through analog synthesis. So I began with #1. After ten minutes, I grew so fascinated with the sounds I was creating that I abandoned the sheet, and immediately launched into a new piece, using all twenty-two oscillators in a mass-sound event ... I ran around the matrix board, gleefully pushing and pulling the pins, altering the sounds and connections in wonderfully mysterious ways until it built to a huge climax.¹⁴

McLean goes on to describe, with wry humour, how Barton is appalled at her non-systematic approach, and insists that she learns at least some of the theory behind the instrument, otherwise she will always ‘lag behind every composer in the field’. As a

¹⁴ McLean, *Hanging Off The Edge*, p. 151.

researcher, I was aware that, in using this rare chance to handle a Synthi 100 as a chance to merely play around on it and enjoy the experience, without motive or analysis, I, too, was lagging behind.

‘Only those who could disappear “modestly” could really witness with authority rather than gawk curiously’, Donna Haraway writes in her account of the emergence of the ‘modest witness’ in experimental scientific environments in the eighteenth century.¹⁵ The modest witness, who is presumed to be male, is able to make himself invisible within the experiment, reporting his findings with an objectivity that demonstrates and helps to create ‘epistemological and social power’.¹⁶ Haraway is clear that this modesty is an illusion – a sort of magical trick that is paradoxically regarded as illustrative of rationality; and that is only made possible by the exclusion of others from the ‘scientific space’. If we agree with Haraway that the modest witness’s knowledge is not the only kind of knowledge that is valuable, however, what value does the curious gawker such as myself bring to the scientific space – or to the electronic music studio? It was obvious to me that my approach to the synthesizer, informed by having played in improvising groups and rock bands, often borrowing a synth for a short period of time or sharing it with bandmates, playing modified, homemade and faulty instruments as well as well-maintained, ‘classic’ synthesizers, had always been more curious than modest, even when trying to perform the role of researcher. There was nothing objective or even consciously inquiring about this approach, but rather an excitement about certain sounds and a gradually accumulated set of tacit ‘rules’ and instructions about how to achieve those sounds that I would struggle to verbalise or transmit to anyone else. Likewise, my knowledge of electronics, when exploring the inside of the Synthi 100 with Tom Carpenter in his garage, soon reached its limits. But these gaps in objective knowledge, this eschewal of – or an inability to inhabit – a ‘modest witness’ role, could also be seen as spaces made for empathetic, embodied knowledge; for an understanding of the place the synthesizer occupied and occupies in its owners’ and players’ imaginations.

These curious encounters with the Synthi 100 can be valuable if we consider them to be part of the ‘map of mediations’ that Tresch and Dolan propose as a means of

¹⁵ Donna Haraway, *Modest_Witness@Second_Millennium.FemaleMan-
© Meets_OncoMouse™: feminism and technoscience* (London: Routledge, 1997), p. 25.

¹⁶ *Ibid.*, p. 24

studying electronic musical instruments.¹⁷ In this context, the curious and partially informed observer, the enthusiast, fan, tinkerer and ‘musiquant’¹⁸ can help us to understand the various historical and contemporary ways – some of which are outlined throughout this study – in which musicians and makers have sought to communicate their enthusiasm about and belief in electronic music, and how listeners and audiences have responded to these attempts. These can include concerts in which vast computers are put on a concert stage, TV broadcasts showing electronic music within networks of other instrumental practice, museum exhibits, YouTube demonstrations, articles in specialist magazines arguing for electronic music’s national importance, and many things in between. The responses to them can range from contempt and confusion to the spark of interest that prompts a listener of electronic music to become a maker. The understanding of attraction and curiosity as a basis for Haraway’s ‘situated knowledges’,¹⁹ and the importance of affective experiences of music and sound, are now part of a sound arts discourse rooted in phenomenology;²⁰ however, I propose in this study that they can also be considered more deeply in histories of music and sound. A curious approach to organology makes use of affective, playful, instinctual or differently informed uses of instruments, as Fiorenzo Palermo also suggests in his recent reading of Hugh Davies’s homemade instruments through a queer studies framework, which, he writes, has the potential for ‘radical rethinking of instrumental identities’.²¹ As a researcher who is also sometimes a curious gawker, acknowledging my own fleeting impressions and affective impressionability through these encounters with instruments points to ways in which the subcultures and ‘undergrounds’ of electronic music history mentioned in my opening chapter might be approached for future study.

¹⁷ Tresch and Dolan, p. 292.

¹⁸ A term used by Bernard Stiegler to describe the person whose active, but not necessarily professional, involvement in music means that ‘he *opens*, and is, in this way, opened: his eyes, his ears and his senses are wide open to sense’. In Stiegler’s formulation the musiquant working with new digital musics possesses a new kind of musical imagination that encompasses ‘literally unheard of (synthetically produced) sounds, analysis by signal processing and algorithmic calculation’; this use of a ‘machinic sensibility’ has the potential to bring together the acts of listening to and creating music. In Bernard Stiegler, *Symbolic Misery 2: The Katastrophe of the Sensible* (Cambridge: Polity Press), pp. 10–15.

¹⁹ Donna Haraway, ‘Situated Knowledges: The Science Question in Feminism and the Privilege of Partial Perspective’, *Feminist Studies*, 14, 3 (1988), pp. 575–599.

²⁰ In texts such as Salome Voeglin, *Listening to Noise and Silence: Towards a Philosophy of Sound Art* (London: Bloomsbury, 2010).

²¹ Fiorenzo Palermo, ‘Instrumental Trouble: a Queer Organology of Hugh Davies’s Found Instruments’, *Inter Alia: A Journal of Queer Studies* (2019).

http://interalia.org.pl/en/artykuly/on_a_rolling_basis.htm

8.4 Possible futures

In Bruno Latour's *Aramis, or the Love of Technology*, the work of 'scientifiction' about a new transport system in Paris, the narrator, Norbert H., says that the student researching a technological project must attempt to locate 'the peak of enthusiasm, at the apex, the point when the thing is irresistible'.²² The suggestion to position oneself at the point at which a project is at its most potentially exciting, the point where it is about what *might be*, is attractive because it is at this point from which compelling texts about a project are often generated, whether that writing is supportive of the enterprise, critical or even fearful of it. It is in part for this reason that my study of EMS is concentrated around the organization's origins and early history. While I recognize this is a biographical limitation, in that it does not provide a full narrative of EMS's trajectory, there are theoretical aspects to situating my account at this speculative, future-facing point that reflect a wider interest in the relations between time and the technologies of media, sound and music.

Understanding contemporary accounts of EMS as being inflected with enthusiasm for future developments hints at the multiple timeframes contained within the studio and its devices, akin to the 'perpetual transformations and structural instability' of technical systems as described by Stiegler in *Technics and Time*.²³ In writing and interviews in the 1969, EMS's Peter Zinovieff looked ahead to a future in which an idealised computer music system had evolved to the point at which 'inspiration' could be automated and the distance between a complex musical idea and its realization was reduced.²⁴ In the early 1970s, Jasia Reichardt's and Jonathan Benthall's writing on the new computer arts by necessity looked to the future of the medium in order to assess its present, as I have described in Chapter Two. For composer and cyberneticist Herbert Brün, writing in 1970, the development of art as well as technology was driven by a desire to reach higher 'levels of communicativity' and to improve the media through which communication is possible; an acknowledgement of these as-yet

²² Bruno Latour, *Aramis, or the Love of Technology*, translated from French by C. Porter (Cambridge, Mass: Harvard University Press, 1993), p. 37.

²³ Bernard Stiegler, *Technics and Time, 1: The Fault of Epimetheus*, translated from French by S. Barker (2000) (Stanford: Stanford University Press, 1994), p. 43.

²⁴ Peter Zinovieff, 'The Special Case of Inspirational Computer Music Scores', *The London Magazine*, 4, 9 (1969), pp. 165–176 (166–7).

unattainable achievements is thus inscribed in the art and technology of the present.²⁵ At a deeper level, Stiegler suggests that the anticipation of a technical object's potential is embedded in the object's technicity, and that this quality of anticipation is central to the human relationship with the technical system.²⁶

In this study, I have begun to explore musical-technical temporalities. A future study might examine in more depth how such temporalities are articulated by instruments, practices and musical compositions, expanding on, for example, the presentation in Chapter Four of the Synthi 100 as a machine that creates time; the temporal aspects of creating music for TV and film, as described in Chapter Five; or the process-oriented works composed in the Radio Belgrade Electronic Studio described in Chapter Six. In electronic music, and particularly in the early era of computer music, time is both a musical and technical parameter that is put under similar pressure as it comes to refer to both the unfolding of music in time, and to the manifestations and relationships of what Georgina Born calls 'nonhuman time', which is to say time that is produced by electronic instruments, computers and recording technology. This temporality of the medium, Born writes, 'interferes technically, conceptually, and aesthetically with the musical temporalities at issue'.²⁷ Processes such as the input and output of musical information into a computerised studio and the use of sequencing, recording and effects such as reverberation, reveal the hybrid synthesis systems of the 1960s and 70s such the one created at EMS to contain and produce a number of complex temporalities, some of which are 'non-human'. It is perhaps not surprising that accounts of electronic music in its early stages also have a complicated relationship with time, looking ahead to a future where 'medium time' exerts less obvious a pressure upon music, rather than acknowledging that the temporalities produced by the media that facilitate electronic music are inseparable from the music itself.

When we apply this kind of complex temporal thinking to histories of electronic music there is the possibility of understanding more clearly how time – musical, technological and historical – has been conceived in relation to music, and the effect that these conceptualizations and articulations of time have had on music itself. An

²⁵ Herbert Brün, 'Technology and the Composer', in *When Music Resists Meaning: The Major Writings of Herbert Brün*, (Middletown: Wesleyan University Press., 2004), p. 171.

²⁶ Stiegler, *Technics and Time*, 1, pp. 81–83.

²⁷ Georgina Born, 'Making Time: Temporality, History and the Cultural Object', *New Literary History*, 46, 3 (2015), pp. 361–386 (p. 380); see also Chapter 7.

inquiry into electronic music histories that focuses in detail on the issue of time, using texts from philosophy of technology and, given its preoccupation with calculational processes, media archaeology, in particular Wolfgang Ernst's notion of the 'chronopoetic' (time-creating) device,²⁸ would be a productive development of some of the ideas and readings introduced in this study.

8.5 Reconstruction and writing

As I suggest in Chapter Seven, practices of reconstruction and restoration, and their various sub-categories, provide a useful and theoretically rich route into a media-archaeologically informed understanding of electronic music histories that can include multi-disciplinary perspectives, bringing together artists, engineers, composers and others in a way that reflects the collaborative practices, flexible roles and dynamic spaces of electronic music's past as well as its present. As well as producing valuable artistic and institutional outcomes, these projects of reoperationalisation can provide important information about the often under-documented and elusive, tacit working practices of electronic music studios, increase our understanding of the vital roles of engineers, studio assistants, programmers and so on, and give deep insights into individual compositions and their creation. For composers, designers and makers, there is great potential for developing their own practice through this hands-on engagement with historic music technologies.

However, the role of the writer in such projects is less clear, particularly when, as Ernst and other media archaeologists assert, sonic and other media technologies encourage, even demand, 'moving beyond the limitations posed by the historiographical reliance on alphabetic writing and below the threshold of narrative contextualization', working towards an understanding of how sonic devices actively hear, produce, calculate and articulate their histories.²⁹ Working with, rather than against this resistance, the writer can instead explore and critique how narrative is used in accounts of music technologies and studios, and analyse the texts that are produced from these environments, with a view to understanding the part that

²⁸ See Wolfgang Ernst, *Chronopoetics: The Temporal Being and Operativity of Technological Media*, translated from German by A. Enns (London: Rowman & Littlefield, 2016).

²⁹ Wolfgang Ernst, *Sonic Time Machines: Explicit Sound, Sirenic Voices, and Implicit Sonicity* (Amsterdam: Amsterdam University Press, 2016), p. 87.

‘narrative contextualisation’ plays in wider perceptions of technology – for example, as I describe in Chapter Seven, exploring and critiquing the myths that circulate around historical instruments or the ways in which museums and other institutions frame technological reconstruction projects for public consumption. We might then ask how a media-archaeological approach to historical music technologies could enhance, disrupt or reconfigure the stories we tell about them. We can also challenge the resistance to writing within this field of enquiry by exploring, instead, new methods of critical-sonic writing that can inform, generate and interact with sonic and audio-technical practices, as I suggest in Chapter One.

Underpinning this study is an interest in the work of those whose relationship with electronic music has, historically, been seen as subsidiary to the more important role of the composer and the nominal inventors of famous instruments, such as Robert Moog. Recent research by Sean Williams, Laura Zattra and others, following the early example of Born’s *Rationalizing Culture*, examines the less well-known figures of electronic music, such as performance technicians and studio assistants.³⁰ I propose that further study of electronic music technology restoration practices and projects will add another perspective to this field. I demonstrate this in Chapter Seven by examining the relationships between present-day composers and engineers and their counterparts in the past; noting how new visual cultures of electronic music influence and perpetuate how we ‘see’ electronic music histories as well as current practice; and outlining different cultures of electronic music restoration, including institutional projects and private enterprises, and the overlap between the two.

Firstly, I propose a more extensive application of philosophies of technology and media to the reconstruction of music and sound-making technologies that also interrogates how composers and musicians in the present day work creatively with older electronic instruments. Secondly, an ethnographic study of the people, groups and institutions concerned with the restoration and preservation of electronic music technologies, in which a writer works closely with those engaged in the practices above, would be valuable not only to historians of electronic music but also to the fields of museum studies, archive studies and ethnomusicology. A specific example of

³⁰ Sean Williams, ‘Interpretation and Performance Practice in Realising Stockhausen’s *Studie II*’, *Journal of the Royal Musical Association* 141, 2 (2016), pp. 445–481; Laura Zattra, ‘Collaborating on Composition: The Role of the Musical Assistant at IRCAM, CCRMA and CSC’, in *Live Electronic Music. Composition, Performance and Study*, by F. Sallis, V. Bertolani, J. Burle and L. Zattra, eds. (Routledge ebook, 2017), pp. 59-80.

this in the near future will be a project concerning the EMS VCS4, a one-off prototype instrument that was built in 1969–70 for use in concerts, and that has been acquired by and is currently being restored by the Electronic Music Studio at Goldsmiths University, London (Fig 8.2).

I have presented an examination of some of the activities and achievements of EMS, an organisation whose ambition, originality and inventiveness are increasingly being recognised through projects that activate its instruments and philosophies, and through the ongoing acknowledgement, in academia and more widely, of the important creative and technological contributions of its founder Peter Zinovieff. Many further aspects of EMS's activities remain to be explored; it is hoped that this study helps build upon what is already a considerable momentum to carry out this work. However, the frameworks for research proposed by this study are also intended to be applicable to other examples of electronic music studios, instruments and environments. In conclusion, this study opens up an enquiry into how musical time of the past is articulated by processes of reoperationalisation as part of a wider enquiry into how histories of electronic music are constructed through technologies, spaces and working practices.

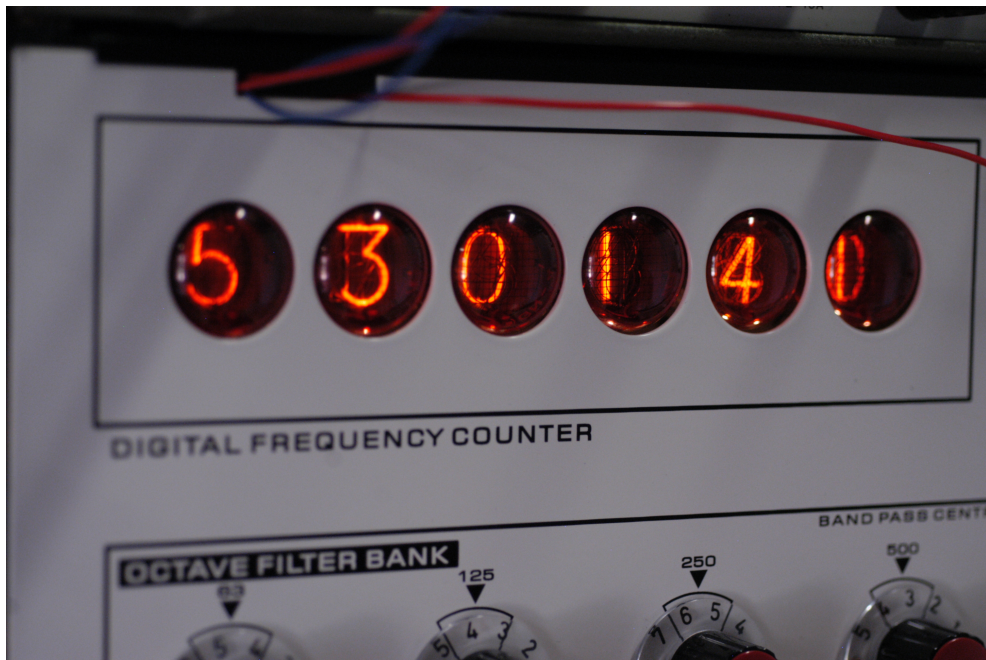

References and Bibliography

Bibliography

Adlington, R. (2006). *The Music of Harrison Birtwistle*. Cambridge: Cambridge University Press.

Adorno, T. (1956). 'Music and New Music'. In *Quasi una Fantasia: Essays on Modern Music*. 3rd edn (2012). Trans. Rodney Livingstone. London and New York: Verso, pp. 249–268.

Aikin, J. (1982). 'The Horizons of Instrument Design: A Conversation with Don Buchla', *Keyboard*, December 1982.

Alt, C. (2011). 'Objects of our affection: how object orientation made computers a medium', in Parikka J, and Huhtamo, E. (eds.), *Media Archaeology: Approaches, Applications, and Implications*. Berkeley: University of California Press, pp. 278–301.

Appadurai, A (ed.) (1984). *The Social life of Things: Commodities in Cultural Perspective*. Cambridge: Cambridge University Press.

Appleton, J. H. and Perera, R. C. (1975). *The Development and Practice of Electronic Music*. Englewood Cliffs, NJ: Prentice-Hall.

Stephen A. (1978). 'Electronic Music Studios in Britain – 9: University of Glasgow' in *Contact*, 19 (Summer 1978), p. 20.

Arts Council of Great Britain (1971). *Twenty-sixth Annual Report and Accounts (1970-1971)*. London: Arts Council of Great Britain.

Ascott, R. (1990). 'Is There Love in the Telematic Embrace?', in *Art Journal* 49 (3), pp. 241-247. New York: College Art Association.

Auslander, P. (2008). *Liveness: Performance in a Mediatized Culture*. 2nd edn. Abingdon/New York: Routledge.

Beard, D. (2012). *Harrison Birtwistle's Operas and Music Theatre*. Cambridge: Cambridge University Press.

Beecroft, N. (2016). *Conversations with Post-World War II Pioneers of Electronic Music*. Toronto: Canadian Music Centre.

- Benjamin, W. (1935). 'The Work of Art in the Age of Mechanical Reproduction'. Translated from German by H. Zohn. In *Illuminations* (1973). London: Fontana.
- Benthall, J. (1972). *Science and Technology in Art Today*. London: Thames & Hudson.
- Bernstein, D. (ed). 2008. *The San Francisco Tape Music Center: 1960s Counterculture and the Avant-garde*. Berkeley: University of California Press.
- Billboard* (1970). no author. 'Putney Bows \$1G "Synth"'. 7 February, p. 78.
- Blake, A. (2009). 'Recording Practices and the Role of the Producer'. In Cook, N, Clarke, E., Leech-Wilkinson, D., and Rink, J. (eds.) *The Cambridge Companion to Recorded Music*. Cambridge: Cambridge University Press, pp. 36-53.
- Born, G. (1995). *Rationalizing Culture: IRCAM, Boulez, and the Institutionalization of the Musical Avant-garde*. Berkeley: University of California Press.
- Born, G. (2010). 'For a Relational Musicology: Music and Interdisciplinarity, Beyond the Practice Turn: the 2007 Dent Medal Address', in *Journal of the Royal Musical Association*, 135 (2), pp. 205–243.
- Born, G. (2015). 'Making Time: Temporality, History and the Cultural Object', in *New Literary History*, 46 (3), pp. 361–386.
- Bowen, M. (1971). 'Variation Forms', in *Music and Musicians*, February 1971, pp. 34–36.
- Bowker, G. C. and Star, S.L. (1999). *Sorting Things Out: Classification and Its Consequences*. Cambridge, Mass; London: MIT Press.
- Brend, M. (2012). *The Sound of Tomorrow: How Electronic Music was Smuggled into the Mainstream*. London: Continuum.
- Brett, G. (1995). *Exploding Galaxies: the Art of David Medalla*. London: Kala Press.
- Brindle, R. S. (1987) *The New Music: The Avant-garde since 1945*. 2nd edn. Oxford: Oxford University Press.
- Briscoe, D., and Curtis-Bramwell, R. (1983) *The BBC Radiophonic Workshop: the First 25 Years*. London : British Broadcasting Corporation.
- Brown, E. (2008) 'On December 1952', in *American Music*, 26 (1), pp. 1–12.

- Brown, P., Gere, C., Lambert, N., and Mason C. (eds.) (2008). *White Heat Cold Logic: British Computer Art 1960–1980*. Cambridge, Mass: MIT Press.
- Brown, S. L. (2016). 'Melbourne's 'Doctor Who' synthesiser EMS Synthi 100 Given Engineering Heritage Award', in *ABC News Australia*, 8 September 2016. www.abc.net.au/news/2016-09-08/melbourne-doctor-who-synth-given-engineering-heritage-award/7820012 (accessed 20 November 2019).
- Brün, H. (1970). 'From Musical Ideas to Computers and Back', in Lincoln, H. (ed.) *The Computer and Music*. New York: Cornell University Press.
- Brün, Herbert (2004). 'Composer's Input Outputs Music', in Brün, H. and Chandra, A. (eds.) *When Music Resists Meaning: the Major Writings of Herbert Brün*. Middletown: Wesleyan University Press.
- Burnand, D., Davies, H., and Sarnaker, B. (1987) 'Electronic Music Studio: Goldsmiths' College, University of London', in *Sound On Sound*, 2 (4), accessed online <http://www.muzines.co.uk/articles/electronic-music-studio/1514> (accessed 20 November 2019).
- Butler, D. (2014). 'Way out of This World!' Delia Derbyshire, *Doctor Who* and the British public's Awareness of Electronic Music in the 1960s', *Critical Studies in Television* 9 (1), pp. 62–76.
- Buxton, W. (1977). *Computer Music: a Directory to Current Work*. Ottawa: UNESCO Commission.
- Candlish, N. A. (2012) 'The Development of Resources for Electronic Music in the UK, with Particular Reference to the Bids to Establish a National Studio'. Unpublished doctoral thesis, University of Durham.
- Carlos, W (1971). 'Walter Carlos on Synthesizers', *The Last Whole Earth Catalog*, June 1971, pp. 330–331. Menlo Park: Portola Institute.
- Cary, T. (1966a). 'Electronic Music – a Call for Action', *Musical Times* 107 (1478), pp. 312-313.
- Cary, T. (1966b). 'Sproggletaggle', *The Composer*, 18 (January), pp. 6–10.
- Cary, T. (1967). 'Moving Pictures from an Exhibition', *The Composer* 25 (autumn), pp. 10–12.
- Cary, T. (1968). 'Why Not a National Sound Laboratory?' *The Guardian* (Manchester), 13 August, p. 6.
- Cary, T. (1971). 'Electronic Music – Background to a Developing Art', *Audio Annual 1971* (pub. *Hi-Fi News*), pp. 42-49.

Cary, T. (1981). 'The Composer and the Machine: a 30 Year Overview', in *Proceedings of the International Music and Technology Conference 1981*. Melbourne: University of Melbourne.

Cary, T. (1992). *Illustrated Compendium of Musical Technology*. London: Faber & Faber.

Cary, T, nd (c.1990-2000). Untitled autobiography. Unpublished: cited with permission Jane Cary.

Casserley, L. (1979). 'Reflections on Ten Years of Electronic Music at the RCM', *RCM Magazine*, autumn 1979, pp. 80–85.

Ceruzzi, P. (2003). *A History of Modern Computing*. Cambridge, Mass: MIT Press.

Chadabe, J. (1997). *Electric Sound: the Past and Promise of Electronic Music*. London: Prentice-Hall International UK.

Chion, M. (1994). *Audio-Vision*. Trans. and ed. by Claudia Gorbman. New York: Columbia University Press.

Chun, W.H.K. (2005). 'On Software, or the Persistence of Visual Knowledge', in *Grey Room*, Issue 18, pp. 26-51.

Chun, W.H.K. (2011). *Programmed Visions: Software and Memory*. Cambridge, MA: MIT Press.

Cohen, T. (2009). *Playing to the Camera – Musicians and Musical Performance in Documentary Cinema*. New York: Wallflower Press/Columbia University Press.

Cole, H. (1973). 'He Doesn't Advance Cautiously' [profile of Peter Zinovieff], *Guardian*, 15 January, p. 8.

Collins, H. and Kusch, M. (1999). *The Shape of Actions: What Humans and Machines Can Do*. Cambridge, MA: MIT Press.

Cooper, Martin (1968). 'Limitless Palette of Electronic Music', *Daily Telegraph*, 19 January.

Cossettini, L. (2018). 'Radio as an Art Form in Former Yugoslavia: *Malo Večno Jezero* by Vladan Radovanović at Radio Belgrade Electronic Studio', in *Musica & Figura* 5., pp. 179–198.

Crabbe, J. (1970). 'Editorial', *Studio Sound*, May, p. 183.

Crogan, P. (2013). 'Experience of the Industrial Temporal Object', in Howells, C., and Moore, G. (eds.) *Stiegler and Technics*. Edinburgh: Edinburgh University Press, pp. 102–118.

- Cross, J. (2000). *Harrison Birtwistle: Man, Mind, Music* London: Faber & Faber.
- Cross, J. (2009). *Harrison Birtwistle: The Mask of Orpheus*. Farnham: Ashgate.
- Crowley, D. and Muzyczuk, D. (eds.) (2012). *Sounding the Body Electric: Experiments in Art and Music in Eastern Europe, 1957–1984*. Łódź: Muzeum Sztuki.
- Crowley, D. (ed.) (2019). *Ultra Sounds: The Sonic Art of Polish Radio Experimental Studio*. Heidelberg: Kehrer.
- Cubitt, K. (1970). 'Dial a Tune', *Guardian*, 3 September.
- Curtis, D. (2007). *A History of Artists' Film and Video in Britain*. London: BFI/Palgrave MacMillan.
- Davies, H. (1968). *Répertoire International des Musiques Electroacoustiques / International Electronic Music Catalog*. Paris & Trumansburg, NY: Groupe de Recherches Musicales de l'ORTF & Independent Electronic Music Center, Inc.
- Davies, Stephen. (2001). *Musical Works and Performances*. Oxford: Oxford University Press.
- Demers, J. (2010). *Listening Through the Noise: The Aesthetics of Experimental Electronic Music*. Oxford: Oxford University Press.
- De Souza, J. (2017). *Music at Hand: Instruments, Bodies and Cognition*. Oxford: Oxford University Press.
- Diduck, R. (2018). *Mad Skills: MIDI and Music Technology in the Twentieth century*. London: Repeater.
- Djurić, D. and Šuvaković, M. (eds.) (2003). *Impossible Histories: Historic Avant-Gardes, Neo-Avant-Gardes, and Post-Avant-Gardes in Yugoslavia, 1918–1991*. Cambridge, Mass: MIT Press.
- Doornbusch, P. (2009). 'Early Hardware and Early Ideas in Computer Music – Their Development and Their Current Forms', in Dean, R. (ed.) *The Oxford Handbook of Computer Music*. Oxford: Oxford University Press.
- Downes, S. (2011). *Hans Werner Henze: Tristan (1973)*. Aldershot: Ashgate.
- Douglas, A. (1973). *Electronic Music Production*. Bath: Pitman.

Drower, J. (2014). *99 Balls Pond Road: The Story of the Exploding Galaxy*. London: Scrudge.

Ebeling, K. (2017). 'The Art of Searching: On "Wild Archaeologies" from Kant to Kittler', *The Nordic Journal of Aesthetics*, 51, pp. 7–18.

Ellul, J. (1964). *The Technological Society*. Translated from French by John Wilkinson. London: New York Books

Emmerson, S. (1977). 'Three Days of Contemporary Music, Athens, June 7–9, 1977', *Contact* 17 (38), pp. 38–40.

Emmerson, S. (ed.) (1986). *The Language of Electroacoustic Music*. London: Macmillan.

Emmerson, S. (1991). 'Live Electronic Music in Britain: Three Case Studies', *Contemporary Music Review* 6 (1), pp. 179-195.

Ernst, W. (2011). 'Media Archaeography: Method and Machine Versus History and Narrative of Media', in Parikka J, and Huhtamo, E. (eds) (2011), *Media Archaeology: Approaches, Applications, and Implications*. Berkeley: University of California Press.

Ernst, W. (2012). *Digital Memory and the Archive*. University of Minnesota Press.

Ernst, W. (2014). 'Towards a Media-Archaeology of Sirenic Articulations: Listening with Media-Archaeological Ears', *The Nordic Journal of Aesthetics*, 48, pp. 7–17.

Ernst, W. (2016a). *Chronopoetics: The Temporal Being and Operativity of Technological media*. Translated from German by A. Enns. London: Rowman & Littlefield.

Ernst, W. (2016b). *Sonic Time Machines: Explicit Sound, Sirenic Voices, and Implicit Sonicity*. Amsterdam: Amsterdam University Press.

von Foerster, H. and Beauchamp, J. (eds.) (1969). *Music by Computers*. New York: Wiley.

Forrest, P. (1994). *The A-Z of Synthesizers: Part One A–M*. Crediton: Susurreal.

Foucault, M. (1969). *The Archaeology of Knowledge*. Translated from French by A. M. Sheridan Smith. London: Tavistock Publications.

Fraser, J. (2009). *My Watermill Story*. Aldeburgh: Sargant.

- Gallope, M. (2006). 'Heidegger, Stiegler, and the Question of a Musical Technics'. Unpublished conference paper: International Conference on Music and Consciousness, University of Sheffield, 17–19 July 2006.
- Gardner, J. (2013a). 'Interview – Peter Zinovieff', supplementary interview to *These Hopeful Machines* series. Radio New Zealand. <http://www.radionz.co.nz/concert/programmes/hopefulmachines/audio/201812332/interview-peter-zinovieff> (accessed 6 December 2019)
- Gardner, J. (2013b). 'Interview – David Cockerell', supplementary interview to *These Hopeful Machines* series. Radio New Zealand, <https://www.rnz.co.nz/concert/programmes/hopefulmachines/audio/201812323/interview-david-cockerell> (accessed 6 December 2019)
- Gardner, J. (2013c). 'Interview – Brian Hodgson', supplementary interview to *These Hopeful Machines* series. Radio New Zealand. <https://www.radionz.co.nz/concert/programmes/hopefulmachines/20131008> (accessed 6 December 2019)
- Gardner, J. (2016). 'Even Orpheus Needs a Synthi', *Tempo* 70, pp. 56-70.
- Gardner, J. (2017). 'The Don Banks Music Box to The Putney: The Genesis and Development of the VCS3 Synthesiser', *Organised Sound* 22 (2), pp. 217–227.
- Gidal, P. (1976). *The Structural Film Anthology*. London: BFI.
- Gill, D. (1969). 'Music in London,' *Musical Times*, 110: 1518 (1969), pp. 852–53.
- Gill, S. (1963). 'A Technique for the Composition of Music in a Computer', in Schwanauer, S. M. and Levitt, D. A. (eds. 1993) *Machine Models of Music*. Cambridge, Mass: MIT Press, pp. 42–53.
- Graham, S. (2012). 'Notes from the Underground: A Cultural, Political, and Aesthetic Mapping of Underground Music'. Unpublished PhD thesis, Goldsmiths, University of London.
- Griffiths, P. (1979). *A Guide to Electronic Music*. London: Thames & Hudson.
- Grogono, P. (1973). 'MUSYS: Software for an Electronic Music Studio', *Software: Practice and Experience* 3 (4), pp. 369–383.
- Grogono, P. (1979). 'Mouse: A Language for Microcomputers', *Byte* 4 (7), pp. 198-108.
- Grogono, P. (c.1985). *Ricordanza*. Unpublished manuscript. Used with permission Peter Grogono.

Groth, S. K. (2014). *Politics and Aesthetics in Electronic Music: A Study of EMS – Elektronmusikstudion Stockholm, 1964-79*. Heidelberg: Kehrer.

Groth, S. K. (2016). 'EMS – The Electronic Music Studio in Stockholm', in Ørum, T. and Olsson, J (eds.), *A Cultural History of the Avant-Garde in the Nordic Countries, 1950-1975*. Leiden: Koninklijke Brill NV.

Hall, T. (2015). 'Before *The Mask*: Birtwistle's Electronic Music Collaborations with Peter Zinovieff', in Beard, D., Gloag, K and Jones, N. (eds.) *Harrison Birtwistle Studies*. Cambridge: Cambridge University Press.

Haraway, D. (1988). 'Situated Knowledges: The Science Question in Feminism and the Privilege of Partial Perspective', *Feminist Studies* 14 (3): 575-599.

Haraway, D. (1997). *Modest_Witness@Second_Millennium. FemaleMan_Meets_OncoMouse: Feminism and Technoscience*. London: Routledge.

Harvey, P. (2005). 'Memorialising the Future - the Musuem of Science and Industry in Manchester', in Bouquet, M. and Porto, N. (eds.), *Science, Magic and Religion: the Ritual Process of Museum Magic*. Oxford: Berghahn Books, pp. 29-50.

Hayles, N. K. (1999). *How We Became Posthuman: Virtual Bodies in Cybernetics, Literature and Informatics*. Chicago: University of Chicago Press.

Hayward, L. (n.d., c.2005). *A Short Autobiography*. Self-published memoir. <http://www.mw0sec.co.uk/> (accessed 20 November 2019)

Helliwell, I. (2016). *Tape leaders: A compendium of Early British Electronic Music Composers*. Cambridge: Sound On Sound.

Henze, H. W. (1982). *Music and Politics: Collected Writings 1953–81*. Translated from German by P. Labanyi. New York: Cornell.

Henze, H. W. (1998). *Bohemian Fifths: An Autobiography*. Translated from German by S. Spencer. London: Faber & Faber.

Hicks, M. (2017). *Programmed Inequality: How Britain Discarded Women Technologists and Lost Its Edge in Computing*. Cambridge, Mass: MIT Press.

Hiller, L. (1970). 'Music Composed with Computers – a Historical Survey', in Lincoln, H (1970). *The Computer in Music*. Ithaca and London: Cornell University Press.

Hills, M. (2002). *Fan Culture*. London and New York: Routledge.

- Hodgson, B. (1977). 'Studio Synthesis', *Studio Sound*, July, p. 44.
- Holmes, T. (2016). *Electronic and Experimental Music: Technology, Music, and Culture*. Routledge: New York/Abingdon.
- Horning, S. S. (2004). 'Engineering the Performance: Recording Engineers, Tacit Knowledge and the Art of Controlling Sound', *Social Studies of Science*, 34 (5), 703–731.
- Horning S. S. (2011). *Chasing sound: technology, culture, and the art of studio recording from Edison to the LP*. Baltimore: Johns Hopkins University Press.
- Howe, H. S. (1982). 'Report on the International Music and Technology Conference', *Computer Music Journal* 6 (2), pp. 45–51.
- Howell, S (1982). Stephen Howell, 'Cardiff University Electronic Music Studio', *Electronics & Music Maker*, April.
- Hunter, F. (2011). 'The sound of Iron Age music: Reconstructing the Deskford Carnyx'. In Staubermann, K. (ed.) *Reconstructions: Recreating Science and Technology of the Past*. Edinburgh: National Museums Scotland.
- Indica Gallery. (1966). *Takis: Magnetic Sculpture and the White Signals*. Exhibition booklet. London: Indica.
- IPEM. (2013). *IPEM: 50 years of Electronic and Electroacoustic Music at the Ghent University*. Ghent: Metaphon.
- Janković, I. (2003). 'Vladan Radovanović's 'Synthesic Art'', *Muzikologija* 2003 (3), pp. 141–186.
- Juliã, C. (2012). 'You Saw it Here First: Gallery One, New Vision Centre, Signals and Indica at Tate Britain', *Tate, Etc*, 24, spring 2012.
- Keane, D. (1981). 'Computer Music: Some Problems and Objectives in Applied Aesthetics'. In *Proceedings of the 1980 International Computer Music Conference*. New York: Queens College of the City University of New York.
- Keane, D. (1984). 'The Bourges International Festival of Experimental Music: A Retrospective', *Computer Music Journal*, 8 (3), autumn 1984, pp. 51-59.
- Kheshti, R. (2020). *Wendy Carlos's Switched-On Bach*. 33 1/3 Series. London: Bloomsbury.

Kieslar, D. (2009). 'A Historical View of Computer Music Technology', in Dean, R. (eds.) *The Oxford Handbook of Computer Music*. Oxford: Oxford University Press.

Kirk, D. (1971). 'The Fine Art of Voltage Control', *Studio Sound*, March, p. 172.

Kirk, D. (1973). 'Field Trials', *Studio Sound*, February 1973, p. 43.

Krpan, E. (ed.) (2000). *Muzički biennale Zagreb, 1961–2001/The Zagreb Music Biennale, 1961–2001*. Zagreb: Croatian Composers' Society.

Kučukalić, Z. (1971). 'Contemporary Trends in Yugoslav Music', *International Review of the Aesthetics and Sociology of Music*, 2 (2), pp. 271-273.

Landy, L. (2007). *Understanding the Art of Sound Organization*. Cambridge, Mass: MIT Press.

Latour, B. (1993). *Aramis, or the Love of Technology*. Translated from French by C. Porter (1996). Cambridge, Mass: Harvard University Press.

Leyshon, A. Matless, D. and Revill, G. (eds.) (1998). *The Place of Music*. New York: Guilford Press.

Lincoln, H (1970). *The Computer in Music*. Ithaca and London: Cornell University Press.

McCaffery, S. and Nichol, b.p. (eds.) (1978). *Sound Poetry: A Catalogue*. Toronto: Underwiche Editions.

MacDonald, I. (2007). *Revolution in the Head: The Beatles' Records and the Sixties*. 4th edn. Chicago: Chicago Review Press.

McLean, P. (2006). *Hanging Off the Edge: Revelations of a Modern Troubadour*. Lincoln, NE: iUniverse.

Maconie, R. (2016). *Other Planets: The Complete Works of Karlheinz Stockhausen*. 2nd edn. Lanham: Rowman & Littlefield.

McPherson, T. (2014). 'Digital Possibilities and the Reimagining of Politics, Place and the Self' in Kinder, M. and McPherson, T. (eds.), *Transmedia Frictions: The Digital, the Arts, and the Humanities*. Berkeley: University of California Press.

Macgregor, B. (2002). 'Cybernetic Serendipity Revisited'. Proceedings of the 4th Conference on Creativity and Cognition, New York: ACM.

Maes, P-J., Lorenzoni, V., Moens, B., Six, J., Bressan, F. (2018). 'Embodied, Participatory Sense-Making in Digitally-Augmented Music

Practices: Theoretical Principles and the Artistic case “SoundBikes”, *Critical Arts*, 32 (3), pp. 77–94.

Manning, P. (2013). *Electronic and Computer Music*. 4th edn. Oxford: Oxford University Press.

Maraš, S. (2019). ‘How Radio Belgrade’s EMS Synthi 100 was repaired’, *Unearthing The Music*, <https://unearthingthemusic.eu/posts/how-radio-belgrades-ems-synthi-100-was-repaired-svetlana-maras/> (accessed 20 November 2019).

Mason, C. (2008). *A Computer in the Art Room: The Origins of British Computer Arts 1950-1980*. London: Quiller Press.

Mason, C. (2009a). ‘The Fortieth Anniversary of Event One at the Royal College of Art’. Conference paper given at Electronic Visualisation and the Arts (EVA) London Conference, July 2009. Accessed via <http://www.catherinemason.co.uk/> (accessed 6 December 2019).

Mathews, M., Miller, J. E., Moore, F. R., Pierce, J. R., Risset, J.C. (1969). *The Technology of Computer Music*. Cambridge, Mass: MIT Press.

Mayer, A (1970). ‘A New Electronic Synthesizer’, *Audio*, May, pp. 28–32.

Medić, I. (2018). ‘The Impossible Avant-Garde of Vladan Radovanović’, *Musicological Annual*, 55 (1), pp. 157–176.

Meigh-Andrews, C. (2007). ‘Peter Donebauer, Richard Monkhouse and the Development of the EMS Spectron and the Videokalos Image Processor’, *Leonardo*, 40 (5), pp. 463–467.

Mendoza, T. (1973). ‘VOCOM – An Entirely New Concept in Communications’, *Practical Electronics*, April 1973, pp. 15–17.

Metzger, G. (1969a). ‘Automata in History’, *Studio International*, March issue, pp. 107–109.

Metzger, G. (1969b). ‘Opinion’, *PAGE* 1, p.1.

Milin, M. (2009). ‘Serbian Music of the Second Half of the 20th Century: From Socialist Realism to Postmodernism’. In Romanou, K. (ed.) (2009) *Serbian and Greek Art Music: A Patch to Western Music History*. Chicago: Intellect.

Milin, M. (2015). ‘Cultural Isolation of Yugoslavia 1944–1960 and its Impact on the Sphere of Music: The Case of Serbia’, *Musicological Annual*, 51 (2), pp. 149-161.

- Milojković, M. (2017). 'Pilgrimage Through a Sound Horizon: A Guide Through the Electroacoustic Works by Vladimir Jovanović (1956–2016)', *New Sound* 49 (1), pp. 79–96.
- Moog, R. (1965). 'Voltage Controlled Analog Devices', *Journal of the Audio Engineering Society*, 13 (3), pp. 200–206.
- Mooney, J. (2014). 'Hugh Davies's Electronic Music Documentation 1961–8'. Proceedings of the Electroacoustic Music Studies Network Conference: Electroacoustic Music Beyond Concert Performance, Berlin, June 2014. Accessed via http://www.ems-network.org/IMG/pdf_EMS14_mooney.pdf (accessed 6 December 2019)
- Moorefield, V. (2005). *The Producer as Composer: Shaping the Sounds of Popular Music*. Cambridge, Mass: MIT Press.
- Morgan, C.P. (1979). *The BYTE Book of Computer Music*. New York: McGraw-Hill.
- Morgan, F. (2014a). 'Exploring the Early Development of the Electroacoustic Music Studio at University of East Anglia in the Context of a Historiography of Electronic Music'. Unpublished MA thesis. Goldsmith's College, University of London.
- Morgan, F. (2014b). 'Experimental laboratory', *The Wire* 365 (July 2014), pp. 32–39.
- Morgan, F. (2017a). 'Delian Modes: Listening for Delia Derbyshire in Histories of Electronic Dance Music', *Dancecult*, 9 (1), online: <https://doi.org/10.12801/1947-5403.2017.09.01.01> (accessed 6 December 2019).
- Morgan, F. (2017b). 'The EMS Synthi 100: Dialogues Between Invention, Preservation and Restoration', *Fylkingen Tongues* (2017), https://fylkingen.se/tongues/index.php/may-tongues_/the-ems-synthi-100-dialogues-between-invention-preservation-and-restoration/ (accessed 6 December 2019).
- Nelson, A. (2015). *The Sound of Innovation: Stanford and the Computer Music Revolution*. Cambridge, MA: MIT Press.
- New Scientist* (1973). (no author) 'Speaking Computer Saves Telephone Lines', 22 February.
- Niebur, L. (2010). *Special Sound: The Creation and Legacy of the BBC Radiophonic Workshop*. Oxford: Oxford University Press.
- Novati, M. and Dack, J. (eds.) (2012). *The Studio di Fonologia – a Musical Journey*. London: Ricordi.

- Nyman, M. (1974). *Experimental Music: Cage and Beyond*. 2nd edn. Littlehampton: Littlehampton Book Services Ltd.
- Ojanen, M., Suominen, J., Kallio, T., and Lassfolk, K. (2007). 'Design Principles and User Interfaces of Erkki Kurenniemi's Electronic Musical Instruments of the 1960s and 1970s'. In *Proceedings of the 2007 Conference on New Interfaces for Musical Expression (NIME07)*. New York: NIME, pp. 83–93.
- Ostertag, B. (2002). 'Human Bodies, Computer Music', *Leonardo Music Journal*, 12, pp. 11-14.
- Palermo, S. F. (2018). 'Instrumental Trouble: A queer organology of Hugh Davies's found instruments', *Inter Alia: a Journal of Queer Studies*. Online: http://interalia.org.pl/en/artykuly/on_a_rolling_basis.htm [Accessed 29 July 2020]
- Parolini, G. (2017). 'Music without Musicians...but with Scientists, Technicians and Computer Companies', *Organised Sound*, 22 (2), pp. 286-296.
- Patteson, T. (2016). *Instruments for New Music: Sound, Technology, and Modernism*. Oakland: University of California Press.
- Patterson, Z. (2015). *Peripheral Vision: Bell Labs, the S-C 4020, and the Origins of Computer Art*. Cambridge, Mass: MIT Press.
- Paulden, S. (1973). 'The One that Got Away', *Observer*, 8 April.
- Percival, J. (2013). 'Delia Derbyshire's Creative Process'. Unpublished MA thesis, University of Manchester.
- Pickering, A. (2010). *The Cybernetic Brain: Sketches of Another Future*. Chicago: University of Chicago Press.
- Piekut, B. (2014). 'Indeterminacy, Free Improvisation and the Mixed Avant-Garde: Experimental Music in London: 1965-75', *Journal of the American Musicological Society*, 67 (3), pp. 769-824.
- Pignon, P. (1974). 'The Radio Belgrade Electronic Studio: Equipment, Procedures, Other Information', *Interface* 3 (2), pp. 177-186.
- Pignon, P. (2019). 'Why I still Want to Make Music on the Synthi 100', *INSAM Journal of Contemporary Music, Art and Technology*, No. 3, Vol. II, December 2019, pp. 15–18.
- Pinch, T. and Trocco, F. (1998). 'The Social Construction of the Early Music Synthesizer', *Icon* 4, pp. 9–31.

Pinch, T. and Trocco, F. (2002). *Analog Days: The Invention and Impact of the Moog Synthesizer*. Cambridge, MA: Harvard University Press.

Parikka, J. (2012). *What is Media Archaeology?* Cambridge, UK: Polity.

Portelli, A (1981). 'The Peculiarities of Oral History', *History Workshop Journal* 12: 1.

Potter, K. (1987). 'Zagreb Music Biennale 1987', *Contact* 32, p. 60.

Third Program (1973). 'Electronic Studio'. Supplement to *Third Program* journal. Belgrade: Radio Television Belgrade, pp. 3–11.

Radovanović, V. (1974). 'The Radio Belgrade Electronic Studio: Philosophy and Aesthetic Orientation', *Interface* (3) 2, 169–176.

Radovanović, V. (1987). *Vocovizuel*. Belgrade: Nolit.

Rees, H. (1970). 'Birtwistle's *Medusa*'. In *Tempo* 92, Spring issue, pp. 28–31.

Reichardt, J. (ed.) (1968). *Cybernetic Serendipity: The Computer and the Arts*. Studio International special edition.

Reichardt, J. (ed.) (1971a). *Cybernetics, Art and Ideas*. New York: New York Graphic Society.

Reichardt, J. (1971b). *The Computer in Art*. London: Vista.

Reid, G. (2000). 'All About EMS, Part 2', *Sound On Sound* December 2000.

Roads, C. (2015). *Composing Electronic Music: A New Aesthetic*. Oxford: Oxford University Press.

Roberts, B. (2012). 'Technics, Individuation and Tertiary Memory: Bernard Stiegler's Challenge to Media Theory', *New Formations*, 77 (1), pp. 8–20.

Rodgers, T. (2015). 'Tinkering with Cultural Memory: Gender and the Politics of Synthesizer Historiography', *Feminist Media Studies*, Fall 2015, pp. 5–30.

Routh, F. (1972). *Contemporary British Music: The Twenty-Five Years from 1945 to 1970*. London: Macdonald and Co.

Routh, F. (2012). 'Redcliffe Concerts of British Music'. Online: http://www.francisrouth.net/redcliffe/wordpress/?page_id=1188 [accessed 16 December 2019].

- Rupprecht, P. (2015). *British Musical Modernism: the Manchester Group and their Contemporaries*. Cambridge: Cambridge University Press.
- Sadie, S (1968). 'More Experiments With Sound', *The Times*, 11 January.
- Sadler, S. (2005). *Archigram: Architecture Without Architecture*. Cambridge, Mass/London: MIT Press.
- Sallis, F., Bertolani, V., Burle, J. and Zattra, L. (eds.) (2017). *Live-Electronic Music: Composition, Performance and Study*. Routledge ebook.
- Samson, J. (2013). *Music in the Balkans*. Leiden: Brill.
- Sanden, P. (2013). *Liveness in Modern Music: Musicians, Technology, and the Perception of Performance*. London: Routledge.
- Schaeffer, P. (1952). *In Search of a Concrete Music*. Translated from French by J. Dack and C. North (2012). Berkeley: University of California Press.
- Schwartz, E. (1975). *Electronic Music: a Listener's Guide*. New York: Praeger.
- Sigman, M. (1971). 'The Case for Synthi A', *Record World*, 2 February.
- Simondon, G. (2016). *On the Mode of Existence of Technical Objects*. Translated from French by C. Malaspina and J. Rogove. Minneapolis: Univocal.
- Sonevytsky, M. (2008). 'The Accordion and Ethnic Whiteness: Toward a New Critical Organology', *The World of Music* 50 (3), pp.101-118.
- Small, C. (1998). *Musicking: The Meanings of Performing and Listening*. Hanover, NH: Wesleyan University Press.
- Small, J. S. (2001). *The Analogue Alternative: The Electronic Analogue Computer in Britain and the USA, 1930-1975*. London: Routledge.
- Smart, G. F. (2002). 'Tristram Cary: Scenes from a Composer's Life'. Unpublished MA thesis, University of Adelaide, Elder Conservatorium of Music.
- Spiegel, L. (1998). 'Graphical GROOVE: Memorial for the VAMPIRE, a Visual Music System', *Organised Sound* 3(3), pp. 187-191.
- Spiegel, L. (1996). 'That Was Then – This Is Now', *Computer Music Journal*, 20 (1), pp. 42-45.

Srećković, B. (2011). 'Vladan Radovanović: *Phonoverse – Electroacoustic Music*, Sokoje, 2010' (review). Translated from Serbian by G. Kapetanović. *New Sound* 38 (11), pp. 109–112.

Star, S. L. (2010). 'This is not a Boundary Object: Reflections on the Origin of a Concept', *Science, Technology, & Human Values*, 35 (5), pp. 601–617.

Star, S. L. and Griesemer, J. R. (1989). 'Institutional Ecology, "Translations", and Boundary Objects: Amateurs and Professionals in Berkeley's Museum of Vertebrate Zoology, 1907–1939', *Social Studies of Science* 19, pp. 387–420.

Stojanović-Novičić, D. (2013). 'Musical Minimalism in Serbia: Emergence, Beginnings and its Creative Endeavours'. In Potter K., Gann, K., and ap Siôn, P. (eds.), *The Ashgate Research Companion to Minimalist and Postminimalist Music*. Farnham: Ashgate.

Sterne, J. and Rodgers, T. (2011). 'The Poetics of Signal Processing', *differences* 22 (2-3), pp. 31–53.

Stiegler, B. (1994). *Technics and Time, 1: The Fault of Epimetheus*. Translated from French by S. Barker (2000). Stanford: Stanford University Press.

Stiegler, B. (1998). *Technics and Time, 2: Disorientation*. Translated from French by S. Barker (2009). Stanford: Stanford University Press.

Stiegler, B. (2000). *Technics and Time, 3: Cinematic Time and the Question of Malaise*. Translated from French by S. Barker (2011). Stanford: Stanford University Press.

Stiegler, B. (2015). *Symbolic Misery 2: The Katastrophe of the Sensible*. Translated from French by B. Norman. Cambridge: Polity.

Stiles, K. and Selz, P. (2012). *Theories and Documents of Contemporary art*. 2nd edn. Oakland: University of California Press.

Strange, A (1983). *Electronic Music: Systems, Techniques, and Controls*. 2nd edn. Dubuque, Iowa: W.C. Brown.

Stockhausen, K. (1989). *Stockhausen on Music: Lectures and Interviews Compiled by Robin Maconie*. London: Marion Boyars.

Suominen, J. (2013). 'Erkki Kurenniemi's Electronic Music Instruments of the 1960s and 1970s'. In Mellais, M. (ed.), *Erkki Kurenniemi: A Man from the Future*. Helsinki: Finnish National Gallery, Central Art Archives.

Sutcliffe, A. (1968). 'Programming to Make Music', *Computer Weekly*, 8 August 1968.

Sutcliffe, A. (2008). 'Patterns in Context'. In Brown, P., Gere, C., Lambert, N., and Mason C. (eds.), *White Heat Cold Logic British Computer Art 1960–1980*. Cambridge, Mass: MIT Press.

Swade, D. (2002). 'Collecting Software: Preserving Information in an Object-Centred Culture'. In Hashagen, U., Reinhard, K-S., and Norberg, A. (eds.), *History of Computing: Software Issues*. Berlin & Heidelberg: Springer, pp. 237-244.

Swade, D. (2011). 'Reconstruction as Experimental History: Historic Computing Machines'. In Staubermann, K (ed.) *Reconstructions: Recreating Science and Technology of the Past*. Edinburgh: National Museums Scotland.

Taylor, C. (1976). *Sounds of Music*. London: British Broadcasting Corporation.

Tazelaar, K. (2012). *On the Threshold of Beauty: Philips and the Origins of Electronic Music in the Netherlands, 1925–1965*. Rotterdam: nai010.

Tempelaars, S. and Koenig, G. M. (1972). 'The Computer at the Institute of Sonology, Utrecht', *Journal of New Music Research*, 1 (2), pp. 167-174.

Théberge, P. (1997). *Any Sound You Can Imagine: Making Music, Consuming Technology*. Hanover: Wesleyan University Press.

Théberge, P. (2017). 'Musical Instruments as Assemblage'. In Bovermann, T., de Campo, A., Egermann, H., Hardjowirogo, S.-I., Weinzierl, S, (eds.) *Musical Instruments in the 21st Century: Identities, Configurations, Practices*. Basel: Springer Link ebook, pp. 59–66.

Turner, F. (2006). *From Counterculture to Cyberculture: Stewart Brand, the Whole Earth Network, and the Rise of Digital Utopianism*. Chicago: University of Chicago Press.

Tresch, J., and Dolan, E. (2013). 'Toward a New Organology: Instruments of Music and Science'. In *Osiris* 28: 278–298

UNESCO. (1971). *Music and Technology: Prepared for UNESCO on the Basis of the Papers and Reports of the Meeting on Music and Technology, Organized by UNESCO in Stockholm, Sweden, in June 1970*. Paris: La Revue Musicale.

Usselman, R. (2003). 'The Dilemma of Media Art: Cybernetic Serendipity at the ICA, London', *Leonardo* 36, (5d), pp. 389–396.

Vail, M. (2014). *The Synthesizer: A Comprehensive Guide to Understanding, Programming, Playing, and Recording the Ultimate Electronic Music Instrument*. New York City: Oxford University Press.

- Voeglin, S. (2010). *Listening to Noise and Silence: Towards a Philosophy of Sound Art*. London: Bloomsbury.
- Waksman, S. (2003). 'Reading the Instrument: An Introduction', *Popular Music and Society* 26 (3), pp. 251-61.
- Warrack, G. (1969). *History of the Royal College of Music (Vol 2), The First Eighty-Five Years: 1883-1968 – and Beyond*. London: Royal College of Music.
- Waters, S. (2006). 'Making the Archive and Archiving the Making: Insights and Outcomes from a Major Research Project', *Organised Sound* 11 (2), pp. 143–147.
- Waters, S. (2008). 'Sound Structures, Social Structures, Technical Structures: Changing Practices and Behaviours in a UK University Studio 1973-2008'. Unpublished paper given at Electroacoustic Music Studies Network International Conference, Paris.
- Weber, M. (1958), *The Rational and Social Foundations of Music*. Translated from German and edited by Martindale, Riedel and Neuwirth. Carbondale, IL: Southern Illinois University Press.
- Weium, F. and Boon, T. (ed.) (2013). *Material Culture and Electronic Sound*. Washington: Smithsonian Institution Scholarly Press.
- Wiener, N. (1948). *Cybernetics: or, Control and Communication in the Animal and the Machine*. New York: John Wiley & Sons.
- Wilford, S. (2011). 'An Ethnographic Study of EMS' Unpublished MA thesis, Goldsmith's College, University of London.
- Williams, S. (2016). 'Interpretation and Performance Practice in Realising Stockhausen's Studie II', *Journal of the Royal Musical Association* 141 (2), pp. 445–481.
- Williamson, J. and Cloonan, M. (2016). *Players' Work Time: A history of the British Musicians' Union, 1893–2013*. Manchester: Manchester University Press.
- Winter, K. (1976). 'Electronic Music Studios in Britain 2: University College, Cardiff', *Contact* 19, pp. 31-2.
- Winter, T. (2015). 'Delia Derbyshire: Sound and Music for the BBC Radiophonic Workshop, 1962-1973'. Unpublished PhD thesis, University of York.
- Withers, D.M. (2015). *Feminism, Digital Culture and the Politics of Transmission*. Lanham, MD: Rowman Littlefield International.

Wolf, B. (2013). 'The SPNM 1943-1975: a Retrospective', *Musical Times*, 54 (1925), pp. 47-66.

Zattra, L., Do Poli, G., and Vidolin, A. (2001). 'Yesterday Sounds Tomorrow: preservation at CSC'. In *Journal of New Music Research*, 30 (4), pp. 407-412.

Zattra, L. (2017). 'Collaborating on Composition: The Role of the Musical Assistant at IRCAM, CCRMA and CSC'. In Sallis, F., Bertolani, V., Burle, J. and Zattra, L. (eds.) *Live-Electronic Music. Composition, Performance and Study*. Routledge ebook, pp. 59-80.

Zielinski, S. (2006). *Deep Time of the Media*. Cambridge: MIT Press.

Zinovieff, P. (1969a) 'The Special Case of Inspirational Computer Music Scores', *The London Magazine*, 4 (9), pp. 165-176.

Zinovieff, P. (1969b). 'A Computerized Electronic Music Studio', *Electronic Music Reports, No. 1*, The Institute of Sonology at the University of Utrecht.

Zinovieff, P. (1977). 'From a Diary: Electronic Music', *PAGE* 38, pp. 2-5.

Zinovieff, P. (1981). 'Don't Make Mozart Learn FORTRAN', in Harris, R.P. (ed.), *Proceedings of the International Music and Technology Conference 1981*. Melbourne: University of Melbourne.

Zinovieff, P. (1982). 'Compositional Attitudes to Electronic Music', *Composer* 76/77, p.8.

Zinovieff, P. (2010). 'Nuzuh', *Cambridge Literary Review*, 1 (3), Easter, pp. 236-248.

Zinovieff, P. (2013). 'EMS Milestones', *PAGE* 69 (Spring).

Zinovieff, S. (2014). *The Mad Boy, Lord Berners, My Grandmother and Me*. London: Jonathan Cape.

Zubillaga, I. C. and Fryberger, A. (2016). "My Responsibility is to be Bold" An interview with Georgina Born', *Transposition: Musique et sciences sociales*. Online: <https://journals.openedition.org/transposition/1511> [accessed 20 November 2019].

TV and radio broadcasts

August 2026: There Will Come Soft Rains. Malcolm Clarke (Composer), Ray Bradbury (Writer). UK: BBC Radio 4, 11 May, 1977.

Concerts from Studio 6. Nevena Popović (Director). Serbia: Radio-Television Serbia, March, 2018.

Machines Like Men. Gordon Rattray Taylor (Writer). UK: BBC 2, 20 August, 1962.

The New Sound of Music. John Mansfield (Producer), Michael Rodd (Writer/Presenter). UK: BBC 2, 5 June, 1979.

Peter Zinovieff. Matthew Fowler (Producer), Katrina Porteous (Writer/Presenter). UK: BBC Radio 4, 14 June, 2004.

Sculptress of Sound: The Lost Works of Delia Derbyshire. Matthew Sweet (Writer/Presenter) UK: BBC Radio 4, 2010.

The Same Trade as Mozart. (1969). David Buckton (Director). UK: BBC 2, 3 August, 1969.

These Hopeful Machines (2013). James Gardner (Writer/Presenter). New Zealand: Radio New Zealand, 2012–13.

Tomorrow's World (1968). UK: BBC1, 6 March, 1968.

Varijacije za TV [Variations for TV] (1985). Vladan Radovanovic (Composer). Yugoslavia: Radio-Television Belgrade. Date of broadcast unknown.

Filmography

Computer Orchestra (1968). Pathé Newsreels, director unknown. UK: British Pathé.

Takis Unlimited (1968). Mahmoud Khosrowshahi (Director). UK.

What the Future Sounded Like. (2006/7). Matthew Bate (Director). Australia/UK: Closer Productions.

Discography

Birtwistle, H. (1975). *The Triumph Of Time/Chronometer*. [LP] London: Argo.

BBC Radiophonic Workshop. (1968). *BBC Radiophonic Music*. [LP] London: BBC Radio Enterprises.

BBC Radiophonic Workshop. (1975). *The Radiophonic Workshop*. [LP] London: BBC Radio Enterprises.

Henze, H. W. (1977). *Tristan* [LP] Germany: Deutsche-Grammophon.

Radovanovic, V. (1975). *The voice from the loudspeaker* [EP] Belgrade: SKC Beograd.

Radovanovic, V. (2010, 2016). *Fonoverzum (Phonoverse)* [LP] Austria: GOD Records.

Various artists. (1968). *Cybernetic Serendipity* [LP] London: ICA.

Various artists. (1977). *Elektronski Studio Radio Beograda*. [LP] Belgrade: Produkcija Gramofonskih Ploča Radio Televizije Beograd (PGP RTB).

Various artists. (1983). *Elektronski Studio Radio Beograda* [LP] Belgrade: Produkcija Gramofonskih Ploča Radio Televizije Beograd (PGP RTB).

Various artists. (2002). *30 Godina Elektronskog Studija Radio Beograda*. [CD] Belgrade: Produkcija gramofonskih ploča Radio-televizije Srbije (PGP RTS).

Various artists. (2013). *Institute For Psychoacoustics And Electronic Music (IPEM) – 50 Years Of Electronic And Electroacoustic Music At The Ghent University* [CD] Heusden-Zolder: Metaphon.

Zinovieff, P. (2015). *Electronic Calendar – The EMS Tapes*. [CD] Corby: Space Age Recordings.

Public Records

London Gazette (1979). 20 December (issue 16112).

Archives

The following archives and institutions allowed me access to collections, documents and objects in the course of this research.

BBC Written Archive, Reading, UK.

R97/11/1: Radiophonic Workshop general

R97/11/1: Radiophonic Workshop general

R97/10/1: Radiophonic Technical committee 1960-69

R97/10/2: Radiophonic Technical committee 1960-69

R97/10/3: Radiophonic Technical committee 1972–75

R97/10/3: Radiophonic Technical committee 1976–77

R97/25/2: Press Cuttings/Scrapbooks (1960s-70s)

Calouste-Gulbenkian Archive, London, UK.

Computer Arts Society Collection, Victoria and Albert Museum, London, UK.

British Library, London, UK.

– Hugh Davies Archive

MS Mus.1803/7/4: Correspondence.

MS Mus. 1803/14/5/1: Correspondence.

MS Mus. 1803 1803/7/9: Correspondence

– Intermodulation Archive

– British Library Sound Archive.

Delia Derbyshire Archive, John Rylands Library, Manchester, UK.

DDA 1/1/5/1-7: Unit Delta Plus misc

DDA 1/1/5/8: Unit Delta Plus misc

DDA 1/1/5/12-16: Unit Delta Plus/Brighton Festival

DDA/1/1/6: Unit Delta Plus/Concert

Jocelyn Herbert Archive, National Theatre, London, UK.

Daphne Oram Archive, Special Collections, Goldsmiths University, London, UK.

Patric Prince Archive, Victoria and Albert Museum, London, UK.

Radio Belgrade Electronic Music Studio Written Archive, Belgrade, Serbia.
Collections accessed: Correspondence, 1969–c.1974

Royal College of Music Archives London, UK.

Science Museum Archives, London & Wroughton, UK

– Alan Sutcliffe Archive

MS/2160 : Collection of objects and archival material relating to the British company Electronic Music Studios (EMS) (1969-1979).

Selected online archives, companies and composer/practitioner websites

Belgrade Music Festival (BEMUS) <https://www.bemus.rs/en/archive.html>

EMS website run by Graham Hinton, currently inactive, accessed on
Wayback Machine December 2019

<https://web.archive.org/web/20130522190744/http://www.ems-synthi.demon.co.uk/index.html>

Music Biennale Zagreb

<http://old.mbz.hr/index.php?opt=news&act=archivemenu&id=29&lang=hr>

EMS Rehberg <http://www.emsrehberg.de/>

Francis Routh <http://www.francisrouth.net/>

Vladan Radovanovic <http://www.vladanradovanovic.rs/>

Interviews and correspondence

Thanks to:

Norma Beecroft

Tom Carpenter

David Dewaele

Stephen Dewaele

Peter Grogono

Les Hayward

Brian Hodgson

Marinos Koutsomichalis

Annea Lockwood

Svetlana Maraš

Barton McLean

Priscilla McLean

Tim Orr

Paul Pignon

Ivan Scheppers

Matthew Scott

Jari Suominen

Sean Williams

Robin Wood

Ksenija Stevanović

Peter Zinovieff

Acknowledgements

This project was made possible by an AHRC Collaborative Doctoral Award. Thank you to AHRC, the Royal College of Art and the Science Museum. My supervisors at the RCA and the Science Museum, David Crowley and Tim Boon, have offered unfailing support and enthusiasm throughout my research. They've been receptive to my many changes in direction, and generous with feedback and encouragement. At the RCA, Chantal Faust and Aura Satz provided extra support in my final year – thank you to them, and to Brian Dillon for inviting me to teach on the RCA's MA in Writing in 2018 and 2019.

The project would not have been possible without the input of EMS founders, staff and associates, who gave up their time to talk to me about their work. Thanks to Peter Grogono, Les Hayward, Tim Orr, Robin Wood and Peter Zinovieff. For their invaluable contributions to my chapters on the Synthi 100, a special thanks to Brian Hodgson and Paul Pignon.

Ivan Scheppers at IPEM in Ghent kindly facilitated my visit there, and was a wealth of knowledge. He also put me in touch with David and Stephen Dewaele, to whom thanks must go for giving me access to the IPEM Synthi 100.

I was not able to visit the Radio Belgrade studio, but Ksenija Stevanović and Svetlana Maraš were extremely helpful with information, interviews, photographs and archive access. I hope to meet them some day. Likewise Jari Suominen, whose restorer's perspective helped shape my thinking on this topic.

Some important parts of this thesis developed from conference papers given between 2015–18. Thank you to the following conferences and institutions for inviting me to present my work: Alternative Histories of Electronic Music, Science Museum, London; RMA Music and Philosophy Study Group; MuSA 2018 at Hochschule für Musik, Karlsruhe; Music 625, University of Leeds; Sound Thought, Glasgow University; Peter Zinovieff Day, University of Surrey; Unsound Barrier, Royal College of Art. It was also a pleasure to present my work at Documenta14, Rewire Festival 2018, and – perhaps the greatest honour of all – CV Freqs modular synth meet.

The Sonic Cyberfeminisms collective provided interdisciplinary support, discussions and comradeship. Thank you: Annie Goh, Marie Thompson, Robin Buckley, Marlo De Lara, Jane Frances Dunlop, Natalie Hyacinth, Miranda Iossifidis, Louise Lawlor and Shanti Suki Osman.

Finally, thank you to friends and family, and fellow scholars and readers: Lucy Woollett, So Mayer, Emily Bick, Karen Di Franco, D-M Withers, Rebecca Kressley, Pat and Lizzie Kaufman, Margaret Morgan, Patrick Ward.

ProQuest Number:28403673

All rights reserved

INFORMATION TO ALL USERS

The quality of this reproduction is dependent on the quality of the copy submitted.

In the unlikely event that the author did not send a complete manuscript and there are missing pages, these will be noted. Also, if material had to be removed, a note will indicate the deletion.



ProQuest 28403673

Published by ProQuest LLC (2021). Copyright of the Dissertation is held by the Author.

All Rights Reserved.

This work is protected against unauthorized copying under Title 17, United States Code
Microform Edition © ProQuest LLC.

ProQuest LLC
789 East Eisenhower Parkway
P.O. Box 1346
Ann Arbor, MI 48106 - 1346